

APJ ABDUL KALAM
TECHNOLOGICAL
UNIVERSITY

SEMESTER VII

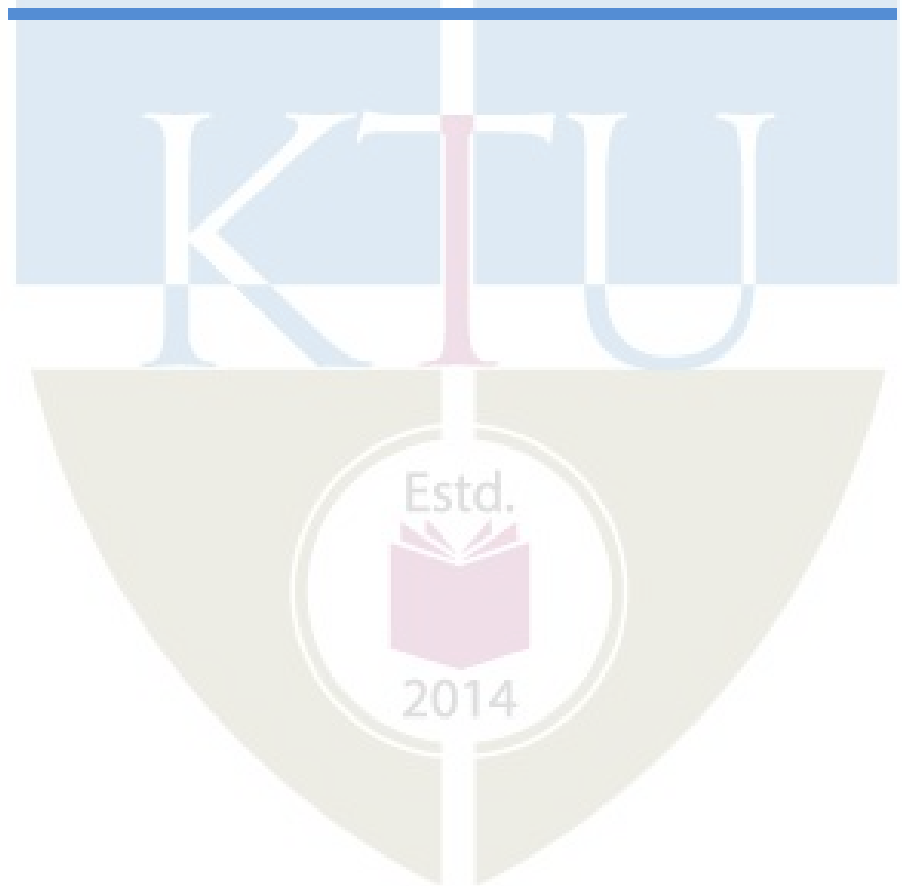

ECT401	MICROWAVES AND ANTENNAS	CATEGORY	L	T	P	CREDIT
		PCC	2	1	0	3

Preamble: This course aims to impart knowledge on the basic parameters of antenna, design and working of various broad band antennas, arrays and its radiation patterns. It also introduces various microwave sources, their principle of operation and study of various microwave hybrid circuits and microwave semiconductor devices.

Prerequisite: ECT 302 ELECTROMAGNETICS

Course Out Comes: After the completion of the course the student will be able to:

CO1-K2	Understand the basic concept of antennas and its parameters.
CO2-K3	Analyze the far field pattern of Short dipole and Half wave dipole antenna.
CO3-K3	Design of various broad band antennas, arrays and its radiation patterns.
CO4-K2	Illustrate the principle of operation of cavity resonators and various microwave sources.
CO5-K2	Explain various microwave hybrid circuits and microwave semiconductor devices.

Mapping of course outcomes with program outcomes:

	PO1	PO2	PO3	PO4	PO5	PO6	PO7	PO8	PO9	PO10	PO11	PO12
CO1	3	3		1								2
CO2	3	3	3	1	2							2
CO3	3	3	3	1	3							2
CO4	3	3	2	1								2
CO5	3	3	2	1								2

Assessment Pattern:

Bloom's Category	Continuous Assessment Tests		End Semester Examination
	1	2	
Remember			
Understand K2	20	20	40
Apply K3	30	30	60
Analyse			
Evaluate			
Create			

Mark distribution:

Total Marks	CIE	ESE	ESE Duration
150	50	100	3 Hours

Continuous Internal Evaluation Pattern:

Attendance	: 10 marks
Continuous Assessment Test (2 numbers)	: 25 marks
Assignment/Quiz/Course project	: 15 marks

End Semester Examination Pattern**Maximum Marks: 100****Time: 3 hours**

End Semester Examination Pattern: There will be two parts; Part A and Part B. Part A contain 10 questions with 2 questions from each module, having 3 marks for each question. Students should answer all questions. Part B contains 2 questions from each module of which student should answer any one. Each question can have maximum 2 subdivisions and carry 14 marks.

Course Level Assessment Questions**Course Outcome 1 (CO1):**

1. Define isotropic radiator and derive the expression for its electric field strength.
2. Explain the terms
 - i) Antenna temperature
 - ii) Antenna efficiency
 - iii) Beam efficiency
 - iv) Radiation pattern
 - v) Antenna Polarization
3. Show that the directivity of a half wave dipole is 4 (from the expression for average power).
4. Find the radiation intensity of a current element with corresponding field strength in the direction of maximum radiation of $E_m = \frac{60}{r\sqrt{80}} V/m$

Course Outcome 2 (CO2):

1. Show that the directivity of a half wave dipole is 4 (from the expression for average power).
2. Derive expressions for the Far Field components and Radiation Resistance and Directivity of a short dipole antenna.
3. State and Prove Reciprocity Theorem.

Course Outcome 3 (CO3):

1. Derive the relation for normalized electrical field in the case of 'n' isotropic array sources
 $E_n = (AF)_n$.
2. Explain the working of a horn antenna. Write down the expression for gain, HPBW and BWFN.
3. Design an Endfire Array and plot its radiation pattern.
4. Design a LPDA with $\tau = 0.85$, $\sigma = 0.03$ for the frequency range 15-45 MHz.

Course Outcome 4 (CO4):

1. Determine the resonant frequency of an air filled rectangular cavity operating in the dominant mode with dimensions as, $a=4\text{cm}$, $b=5\text{cm}$ and $d=6\text{cm}$.
2. Derive power output and efficiency of a reflex klystron.
3. What is the significance of slow wave structures used in microwave circuits? Explain different slow wave structures with neat sketches.
4. With neat diagram explain the operation of a travelling wave tube.
5. With the help of figures explain the bunching process of an 8-cavity cylindrical magnetron.

Course Outcome 5 (CO5):

1. Explain S-parameters and its properties.
2. With a schematic describe the operation of a four port circulator. Obtain the simplified S matrix of a perfectly matched, lossless four port circulator.
3. Explain RWH theory of Gunn Oscillation.
4. Define Gunn Effect and with the help of figures explain different modes of operation of Gunn diode.

Syllabus

Module	Course contents	Hours
I	Basic antenna parameters: gain, directivity, beam width and effective aperture calculations, effective height, wave polarization, radiation resistance, radiation efficiency, antenna field zones. Duality and Principles of reciprocity, Helmholtz theorem (derivation required), Field, directivity and radiation resistance of a short dipole and half wave dipole (far field derivation).	7
II	Broad band antenna: Principle of Log periodic antenna array and design, Helical antenna: types and design. Design of Microstrip Rectangular Patch antennas and feeding methods. Principles of Horn, Parabolic dish antenna (expression for E, H and Gain without derivation), Mobile phone antenna – Inverted F antenna.	6
III	Arrays of point sources, field of two isotropic point sources, principle of pattern multiplication, linear arrays of 'n' isotropic point sources. Array factor, Grating lobes. Design of Broadside, End fire and Dolph Chebyshev arrays. Concept of Phase array.	8
IV	Microwaves: Introduction, advantages, Cavity Resonators- Derivation of resonance frequency of Rectangular cavity. Single cavity klystron- Reflex Klystron Oscillators: Derivation of Power output, efficiency and admittance. Magnetron oscillators: Cylindrical magnetron, Cyclotron angular frequency, Power output and efficiency. Travelling Wave Tube: Slow wave structures, Helix TWT, Amplification process, Derivation of convection current, axial electric field, wave modes and gain.	8

V	<p>Microwave Hybrid circuits: Scattering parameters, Waveguide Tees- Magic tees, Hybrid rings. Formulation of S-matrix. Directional couplers: Two hole directional couplers, S-matrix. Circulators and Isolators. Phase Shifter.</p> <p>Microwave Semiconductor Devices: Amplifiers using MESFET. Principle of Gunn diodes: Different modes, Principle of operation Gunn Diode Oscillators.</p>	6
---	---	---

Text Books:

1. Balanis, Antenna Theory and Design, 3/e, Wiley Publications.
2. John D. Krauss, Antennas for all Applications, 3/e, TMH.
3. K D Prasad, Antenna and Wave Propagation, Satyaprakash Publications
4. Samuel Y. Liao, Microwave Devices and Circuits, 3/e, Pearson Education, 2003.
5. Robert E. Collin, Foundation of Microwave Engineering, 2/e, Wiley India, 2012.

References:

1. Collin R.E, Antennas & Radio Wave Propagation, McGraw Hill. 1985.
2. Jordan E.C. & K. G. Balmain, Electromagnetic Waves & Radiating Systems, 2/e, PHI.
3. Raju G.S.N., Antenna and Wave Propagation, Pearson, 2013.
4. Sisir K.Das & Annapurna Das, Antenna and Wave Propagation, McGraw Hill, 2012
5. Thomas A. Milligan, Modern Antenna Design, IEEE PRESS, 2/e, Wiley Inter science.
6. Das, Microwave Engineering, 3/e, McGraw Hill Education India Education, 2014
7. David M. Pozar, Microwave Engineering, 4/e, Wiley India, 2012.

Course Contents and Lecture Schedule.

No	Topic	No.of Lectures
Module I		
1.1	Basic antenna parameters (all parameters and related simple problems), Relation between parameters (derivation required)	2
1.2	Principles of reciprocity (proof required), Duality. Concept of retarded potential	1
1.3	Helmholtz theorem (derivation required)	
1.4	Derivation of Field, directivity and radiation resistance of a short dipole	2
1.5	Derivation of Field, directivity and radiation resistance of a half wave dipole.	2
Module II		
2.1	Principle of Log periodic antenna array and design, Helical antenna: types and design	2
2.2	Design of Rectangular Patch antennas and feeding techniques	2
2.3	Principles of Horn, Parabolic dish antenna, (expression for E, H, G without derivation).	1
2.4	Mobile phone antenna – Inverted F antenna.	1
Module III		

3.1	Arrays of point sources, field of two isotropic point sources, principle of pattern multiplication	2
3.2	Linear arrays of 'n' isotropic point sources. Grating lobes. Array factor (derivation)	2
3.3	Design of Broadside, End fire and Dolph Chebyshev arrays.	3
3.4	Concept of Phase array.	1
Module IV		
4.1	Microwaves: Introduction, advantages, Cavity Resonators-Types, Derivation of resonance frequency of Rectangular cavity (problems required)	1
4.2	Single cavity klystron- Reflex Klystron Oscillators: Derivation of Power output, efficiency and admittance.(problems required)	2
4.3	Magnetron oscillators: Cylindrical magnetron, Cyclotron angular frequency, Power output and efficiency.(problems required)	2
4.4	Travelling Wave Tube: Slow wave structures, Helix TWT,Amplification process, Derivation of convection current, axialelectric field, wave modes and gain. (problems required)	3
Module V		
5.1	Microwave Hybrid circuits: Scattering parameters, Waveguide Tees- Magic tees, Hybrid rings.Formulation of S-matrix.	1
5.2	Directional couplers: Two hole directional couplers, S-matrix. Circulators and Isolators. Phase Shifter.	2
5.3	Microwave Semiconductor Devices: Amplifiers using MESFET.	1
5.4	Principle of Gunn diodes: Different modes, Principle of operation Gunn Diode Oscillators.	2

Simulation Assignments (ECT 401)

The following simulation assignments can be done with MATLAB/HFSS/CST Microwave Studio or any Open software.

- Simulation of radiation pattern of
 - a) Microstrip patch antenna
 - b) Arrays
 - c) Helical antenna

Model Question paper

APJ ABDUL KALAM TECHNOLOGICAL UNIVERSITY
SEVENTH SEMESTER B. TECH DEGREE EXAMINATION

Course Code: ECT401

Course Name: MICROWAVES AND ANTENNAS

Max. Marks:100

Duration: 3 Hours

PART A

(Answer All Questions)

- 1 Derive an expression for aperture area of an antenna. (3)
- 2 (i) Obtain the radiation resistance of a thin dipole antenna of length $\lambda/15$. (3)
(ii) Find HPBW of an antenna which has a field given by:
 $E(\theta) = \cos^2 \theta$, for $0 \leq \theta \leq 90^\circ$.
- 3 Why Log Periodic antenna is called as Frequency Independent antenna, explain? (3)
- 4 Briefly explain about Inverted F antenna. (3)
- 5 Explain (i) Pattern Multiplication (ii) Grating lobes (3)
- 6 Demonstrate the working principle of Phase Arrays. (3)
- 7 Derive the resonant frequency of a rectangular cavity resonator. (3)
- 8 What are re-entrant cavities? Show that they support infinite number of resonant frequencies. (3)
- 9 Explain with figure a ferrite isolator can support only forward direction waves. (3)
- 10 Write a short note on Phase shifter. (3)

PART B

(Answer one question from each module. Each question carries 14 marks)

MODULE I

- 11 a) Define the terms (i) Retarded potential (ii) Antenna field zones (4)
b) Derive expressions for the Far Field components and Radiation Resistance and Directivity of a short dipole antenna. (10)
- OR**
- 12a) State and prove Helmholtz theorem (7)
b) (i) Compute the radiation resistance, power radiated and efficiency of an antenna having total resistance of 50Ω and effective height of 69.96m and a current of 50A (rms) at 0.480MHz. (7)
(ii) Calculate the effective aperture of a short dipole antenna operating at 100 MHz.

MODULE II

- 13 a) Explain the working of a parabolic dish antenna. Write down the expression for gain, HPBW and BWFN. (6)
- b) Design a rectangular microstrip antenna using a dielectric substrate with dielectric constant of 2.2, $h = 0.1588$ cm so as to resonate at 10 GHz. (8)

OR

- 14 a) Explain the working of a Log periodic dipole array and explain its design steps. (7)
- b) Explain axial mode helical antenna. Write down the expression for gain, HPBW, BWFN and radiation resistance of axial mode helical antenna. (7)

MODULE III

- 15 Derive expression for array factor of N isotropic sources for end-fire array and also the expression for major lobe, minor lobes and Nulls of the array. (14)

OR

- 16 a) Explain Chebyshev array and write down the expression for array factor. (7)
- b) Design a Broadside Array and plot its radiation pattern. (7)

MODULE IV

- 17a) A reflex klystron operates under the following conditions: $V_0 = 500V$, $R_{sh} = 10K\Omega$, $f_r = 8$ GHz, $L = 1$ mm, $e/m = 1.759 \times 10^{11}$ (MKS system) The tube is oscillating at f_r at the peak of the $n = 2$ or mode. Assume that the transit time through the gap and beam loading to be neglected. Determine: - (7)
- The value of the repeller voltage V_r .
 - The direct current necessary to give a microwave gap voltage of 200V.
 - The electronic efficiency under this condition.
- b) Assuming pi mode of oscillations explain how a magnetron can sustain its oscillations using the cross field. (7)

OR

- 18 a) Show that the axial electric field of TWT varies with convection current. (7)
- b) Explain the electronic admittance of the gap in the case of reflex klystron. With admittance diagram explain the condition required for oscillation in a reflex Klystron. (7)

MODULE V

- 19 a) Explain the working of a microwave amplifiers using MESFET (8)
- b) Explain the constructional features of two-hole directional coupler and derive the S Matrix. (6)

OR

- 20 a) Draw the J-E characteristics of Gunn diode and explain its operation. (10)
- b) Discuss the constructional features of magic tees and derive its S Matrix. Why are they called so? (4)

ECL411	ELECTROMAGNETICS LAB	CATEGORY	L	T	P	CREDIT
		PCC	0	0	3	2

Preamble: This course aims to

- (i) Provide practical experience in design and analysis of few electronic devices and circuits used for Microwave and Optical communication engineering.
- (ii) Familiarize students with simulation of basic Antenna experiments with simulation tools.

Prerequisite: Nil

Course Outcomes: After the completion of the course the student will be able to

CO1	Familiarize the basic Microwave components and to analyse few microwave measurements and its parameters.
CO2	Understand the principles of fiber-optic communications and the different kind of losses, signal distortion and other signal degradation factors.
CO3	Design and simulate basic antenna experiments with simulation tools.

Mapping of course outcomes with program outcomes

	PO1	PO2	PO3	PO4	PO5	PO6	PO7	PO8	PO9	PO10	PO11	PO12
CO1	3	3	3						3			3
CO2	3	3	3						3			3
CO3	3	3	3	2	3				3			3

Assessment Mark distribution

Total Marks	CIE	ESE	ESE Duration
150	75	75	3 hours

Continuous Internal Evaluation Pattern:

Attendance	:	15 marks
Continuous Assessment	:	30 marks
Internal Test (Immediately before the second series test):	:	30 marks

End Semester Examination Pattern: The following guidelines should be followed regarding award of marks

- | | |
|---|------------|
| (a) Preliminary work | : 15 Marks |
| (b) Implementing the work/ Conducting the experiment | : 10 Marks |
| (c) Performance, result and inference (usage of equipments and troubleshooting) | : 25 Marks |
| (d) Vivavoce | : 20 Marks |
| (e) Record | : 5 Marks |

General instructions: End-semester practical examination is to be conducted immediately after the second series test covering entire syllabus given below. Evaluation is to be conducted under the equal responsibility of both the internal and external examiners. The number of candidates evaluated per day should not exceed 20. Students shall be allowed for the examination only on submitting the duly certified record. The external examiner shall endorse the record.

Course Level Assessment Questions (Examples only):

Course Outcome 1 (CO1): Microwave Experiments

- 1) Verify the relation $\lambda_c = 2a$.
- 2) Find the unknown impedance of the given load using Transmission line equation and verify using Smith chart.
- 3) Compare the reflection coefficient of the given horn antenna and matched termination.
- 4) Find the coupling coefficient of the given Directional Coupler.
- 5) Plot Reflex Klystron repeller mode characteristics.
- 6) Find the threshold voltage of Gunn diode from its characteristics.

Course Outcome 2 (CO2): Optical Experiments

- 1) Find the numerical aperture and V number of the given fiber.
- 2) Obtain the bending loss and attenuation loss of the given fiber.
- 3) Plot the V-I characteristics of Laser diode.
- 4) Plot the V-I characteristics of LED.

List of Experiments:

I. MICROWAVE EXPERIMENTS (Minimum Four Experiments are mandatory)

1. Reflex Klystron Mode Characteristics.
2. GUNN diode characteristics.
3. VSWR and Frequency measurement.
4. Verify the relation between Guide wave length, free space wave length and cut off wave length for rectangular wave guide.

5. Unknown load impedance measurement using smith chart and verification using transmission line equation.
6. Measurement of Magic Tee characteristics.
7. Directional Coupler Characteristics.
8. Crystal Index Measurement.

II. OPTICAL EXPERIMENTS (Minimum Three Experiments are mandatory)

1. Setting up of Fiber optic Digital link.
2. Measurement of Numerical Aperture of a fiber.
3. Study of losses in Optical fiber.
4. Voltage vs. Current (V-I) characteristics of Laser Diode.
5. Voltage vs. Current (V-I) characteristics of LED.
6. Characteristics of Photodiode

III. ANTENNA EXPERIMENTS (Minimum Three Experiments are mandatory)

1. Familiarization of any antenna simulation software.
2. Simulation of Dipole Antenna.
3. Simulation of Patch Antenna.
4. Simulation of Antenna Array.
5. Study of Vector Network Analyzer.
6. Antenna Pattern Measurement

Text Books

1. Samuel Y. Liao, Microwave Devices and Circuits, 3/e, Pearson Education, 2003.
2. Gred Keiser Optical Fiber Communication 5/e Mc Graw Hill, 2013
3. Balanis, Antenna Theory and Design, 3/e, Wiley Publications.

References

1. John D. Krauss, Antennas for all Applications, 3/e, TMH.
2. Thomas A. Milligan, Modern Antenna Design, IEEE PRESS, 2/e, Wiley Inter science.
3. N.O. Sadiku and S.V. Kulkarni, *Principles of Electromagnetics*, Sixth Edition, Oxford University Press, India, 2015 (Asian adaptation of 'M.N.O. Sadiku, Elements of Electromagnetics, Sixth International Edition, Oxford University Press')

ECQ413	SEMINAR	CATEGORY	L	T	P	CREDIT
		PWS	0	0	3	2

Preamble: The course ‘Seminar’ is intended to enable a B.Tech graduate to read, understand, present and prepare report about an academic document. The learner shall search in the literature including peer reviewed journals, conference, books, project reports etc., and identify an appropriate paper/thesis/report in her/his area of interest, in consultation with her/his seminar guide. This course can help the learner to experience how a presentation can be made about a selected academic document and also empower her/him to prepare a technical report.

Course Objectives:

- To do literature survey in a selected area of study.
- To understand an academic document from the literature and to give a presentation about it.
- To prepare a technical report.

Course Outcomes [COs] : After successful completion of the course, the students will be able to:

CO1	Identify academic documents from the literature which are related to her/his areas of interest (Cognitive knowledge level: Apply).
CO2	Read and apprehend an academic document from the literature which is related to her/ his areas of interest (Cognitive knowledge level: Analyze).
CO3	Prepare a presentation about an academic document (Cognitive knowledge level: Create).
CO4	Give a presentation about an academic document (Cognitive knowledge level: Apply).
CO5	Prepare a technical report (Cognitive knowledge level: Create).

Mapping of course outcomes with program outcomes:

	PO1	PO2	PO3	PO4	PO5	PO6	PO7	PO8	PO9	PO10	PO11	PO12
CO1	2	2	1	1		2	1					3
CO2	3	3	2	3		2	1					3
CO3	3	2			3			1		2		3
CO4	3				2			1		3		3
CO5	3	3	3	3	2	2		2		3		3

Abstract POs defined by National Board of Accreditation			
PO#	Broad PO	PO#	Broad PO
PO1	Engineering Knowledge	PO7	Environment and Sustainability
PO2	Problem Analysis	PO8	Ethics
PO3	Design/Development of solutions	PO9	Individual and team work
PO4	Conduct investigations of complex problems	PO10	Communication
PO5	Modern tool usage	PO11	Project Management and Finance
PO6	The Engineer and Society	PO12	Life long learning

General Guidelines

- The Department shall form an Internal Evaluation Committee (IEC) for the seminar with academic coordinator for that program as the Chairperson/Chairman and seminar coordinator & seminar guide as members. During the seminar presentation of a student, all members of IEC shall be present.
- Formation of IEC and guide allotment shall be completed within a week after the University examination (or last working day) of the previous semester.
- Guide shall provide required input to their students regarding the selection of topic/paper.
- Choosing a seminar topic: The topic for a UG seminar should be current and broad based rather than a very specific research work. It's advisable to choose a topic for the Seminar to be closely linked to the final year project area. Every member of the project team could choose or be assigned Seminar topics that covers various aspects linked to the Project area.
- A topic/paper relevant to the discipline shall be selected by the student during the semester break.
- Topic/Paper shall be finalized in the first week of the semester and shall be submitted to the IEC.
- The IEC shall approve the selected topic/paper by the second week of the semester.
- Accurate references from genuine peer reviewed published material to be given in the report and to be verified.

Evaluation pattern

Total marks: 100, only CIE, minimum required to pass 50

Seminar Guide: 20 marks (Background Knowledge – 10 (The guide shall give deserving marks for a candidate based on the candidate's background knowledge about the topic selected), Relevance of the paper/topic selected – 10).

Seminar Coordinator: 20 marks (Seminar Diary – 10 (Each student shall maintain a seminar diary and the guide shall monitor the progress of the seminar work on a weekly basis and shall approve the entries in the seminar diary during the weekly meeting with the student), Attendance – 10).

Presentation: 40 marks to be awarded by the IEC (Clarity of presentation – 10, Interactions – 10 (to be based on the candidate's ability to answer questions during the interactive session of her/his presentation), Overall participation – 10 (to be given based on her/his involvement during interactive sessions of presentations by other students), Quality of the slides – 10).

Report: 20 marks to be awarded by the IEC (check for technical content, overall quality, templates followed, adequacy of references etc.).



ECD415	PROJECT PHASE I	CATEGORY	L	T	P	CREDIT
		PWS	0	0	6	2

Preamble: The course ‘Project Work’ is mainly intended to evoke the innovation and invention skills in a student. The course will provide an opportunity to synthesize and apply the knowledge and analytical skills learned, to be developed as a prototype or simulation. The project extends to 2 semesters and will be evaluated in the 7th and 8th semester separately, based on the achieved objectives. One third of the project credits shall be completed in 7th semester and two third in 8th semester. It is recommended that the projects may be finalized in the thrust areas of the respective engineering stream or as interdisciplinary projects. Importance should be given to address societal problems and developing indigenous technologies.

Course Objectives

- To apply engineering knowledge in practical problem solving.
- To foster innovation in design of products, processes or systems.
- To develop creative thinking in finding viable solutions to engineering problems.

Course Outcomes [COs] :After successful completion of the course, the students will be able to:

CO1	Model and solve real world problems by applying knowledge across domains (Cognitive knowledge level: Apply).
CO2	Develop products, processes or technologies for sustainable and socially relevant applications (Cognitive knowledge level: Apply).
CO3	Function effectively as an individual and as a leader in diverse teams and to comprehend and execute designated tasks (Cognitive knowledge level: Apply).
CO4	Plan and execute tasks utilizing available resources within timelines, following ethical and professional norms (Cognitive knowledge level: Apply).
CO5	Identify technology/research gaps and propose innovative/creative solutions (Cognitive knowledge level: Analyze).
CO6	Organize and communicate technical and scientific findings effectively in written and oral forms (Cognitive knowledge level: Apply).

Mapping of course outcomes with program outcomes

	PO1	PO2	PO3	PO4	PO5	PO6	PO7	PO8	PO9	PO10	PO11	PO12
CO1	2	2	2	1	2	2	2	1	1	1	1	2
CO2	2	2	2		1	3	3	1	1		1	1
CO3									3	2	2	1
CO4					2			3	2	2	3	2
CO5	2	3	3	1	2							1
CO6					2			2	2	3	1	1

Abstract POs defined by National Board of Accreditation			
PO#	Broad PO	PO#	Broad PO
PO1	Engineering Knowledge	PO7	Environment and Sustainability
PO2	Problem Analysis	PO8	Ethics
PO3	Design/Development of solutions	PO9	Individual and team work
PO4	Conduct investigations of complex problems	PO10	Communication
PO5	Modern tool usage	PO11	Project Management and Finance
PO6	The Engineer and Society	PO12	Lifelong learning

PROJECT PHASE I

Phase 1 Target

- Literature study/survey of published literature on the assigned topic
- Formulation of objectives
- Formulation of hypothesis/ design/ methodology
- Formulation of work plan and task allocation.
- Block level design documentation
- Seeking project funds from various agencies
- Preliminary Analysis/Modeling/Simulation/Experiment/Design/Feasibility study
- Preparation of Phase 1 report

Evaluation Guidelines & Rubrics

Total: 100 marks (Minimum required to pass: 50 marks).

- Project progress evaluation by guide: 30 Marks.
- Interim evaluation by the Evaluation Committee: 20 Marks.
- Final Evaluation by the Evaluation Committee: 30 Marks.
- Project Phase - I Report (By Evaluation Committee): 20 Marks.

(The evaluation committee comprises HoD or a senior faculty member, Project coordinator and project supervisor).

The guide/supervisor shall monitor the progress being carried out by the project groups on a regular basis. In case it is found that progress is unsatisfactory it shall be reported to the Department Evaluation Committee for necessary action. The presence of each student in the group and their involvement in all stages of execution of the project shall be ensured by the guide. Project evaluation by the guide: 30 Marks. This mark shall be awarded to the students in his/her group by considering the following aspects:

Topic Selection: innovativeness, social relevance etc. (2)

Problem definition: Identification of the social, environmental and ethical issues of the project problem. (2)

Purpose and need of the project: Detailed and extensive explanation of the purpose and need of the project. (3)

Project Objectives: All objectives of the proposed work are well defined; Steps to be followed to solve the defined problem are clearly specified. (2)

Project Scheduling & Distribution of Work among Team members: Detailed and extensive Scheduling with timelines provided for each phase of project. Work breakdown structure well defined. (3)

Literature survey: Outstanding investigation in all aspects. (4)

Student's Diary/ Daily Log: The main purpose of writing daily diary is to cultivate the habit of documenting and to encourage the students to search for details. It develops the students' thought process and reasoning abilities. The students should record in the daily/weekly activity diary the day to day account of the observations, impressions, information gathered and suggestions given, if any. It should contain the sketches & drawings related to the observations made by the students. The daily/weekly activity diary shall be signed after every day/week by the guide. (7)

Individual Contribution: The contribution of each student at various stages. (7)

EVALUATION RUBRICS for PROJECT Phase I: Interim Evaluation

No.	Parameters	Marks	Poor	Fair	Very Good	Outstanding
1-a	Topic identification, selection, formulation of objectives and/or literature survey. (Group assessment) [CO1]	10	The team has failed to come with a relevant topic in time. Needed full assistance to find a topic from the guide. They do not respond to suggestions from the evaluation committee and/or the guide. No literature review was conducted. The team tried to gather easy information without verifying the authenticity. No objectives formed yet.	The team has identified a topic. The originally selected topic lacks substance and needs to be revised. There were suggestions given to improve the relevance and quality of the project topic. Only a few relevant references were consulted/ studied and there is no clear evidence to show the team's understanding on the same. Some objectives identified, but not clear enough.	Good evidence of the group thinking and brainstorming on what they are going to build. The results of the brainstorming are documented and the selection of topic is relevant. The review of related references was good, but there is scope of improvement. Objectives formed with good clarity, however some objectives are not realistic enough.	The group has brainstormed in an excellent manner on what they were going to build. The topic selected is highly relevant, real world problem and is potentially innovative. The group shows extreme interest in the topic and has conducted extensive literature survey in connection with the topic. The team has come up with clear objectives which are feasible.
			(0 – 3 Marks)	(4 – 6 Marks)	(7 - 9 Marks)	(10 Marks)
1-b	Project Planning, Scheduling and Resource/ Tasks Identification and allocation. (Group assessment) [CO4]	10	No evidence of planning or scheduling of the project. The students did not plan what they were going to build or plan on what materials / resources to use in the project. The students do not have any idea on the budget required. The team has not yet decided on who does what. No project journal kept.	Some evidence of a primary plan. There were some ideas on the materials /resources required, but not really thought out. The students have some idea on the finances required, but they have not formalized a budget plan. Schedules were not prepared. The project journal has no details. Some evidence on task allocation among the team members.	Good evidence of planning done. Materials were listed and thought out, but the plan wasn't quite complete. Schedules were prepared, but not detailed, and needs improvement. Project journal is presented but it is not complete in all respect / detailed. There is better task allocation and individual members understand about their tasks. There is room for improvement.	Excellent evidence of enterprising and extensive project planning. Gantt charts were used to depict detailed project scheduling. A project management/version control tool is used to track the project, which shows familiarity with modern tools. All materials / resources were identified and listed and anticipation of procuring time is done. Detailed budgeting is done. All tasks were identified and incorporated in the schedule. A well-kept project journal shows evidence for all the above, in addition to the interaction with the project guide. Each member knows well about their individual tasks.
			(0 – 3 Marks)	(4 – 6 Marks)	(7 - 9 Marks)	(10 Marks)
Phase 1 Interim Evaluation Total Marks: 20						

EVALUATION RUBRICS for PROJECT Phase I: Final Evaluation

Sl. No.	Parameters	Marks	Poor	Fair	Very Good	Outstanding
1-c	Formulation of Design and/or Methodology and Progress. (Group assessment) [CO1]	5	None of the team members show any evidence of knowledge about the design and the methodology adopted till now/ to be adopted in the later stages. The team has not progressed from the previous stage of evaluation.	The students have some knowledge on the design procedure to be adopted, and the methodologies. However, the team has not made much progress in the design, and yet to catch up with the project plan.	The students are comfortable with design methods adopted, and they have made some progress as per the plan. The methodologies are understood to a large extent.	Shows clear evidence of having a well- defined design methodology and adherence to it. Excellent knowledge in design procedure and its adaptation. Adherence to project plan is commendable.
			(0 – 1 Marks)	(2 – 3 Marks)	(4 Marks)	(5 Marks)
1-d	Individual and Teamwork Leadership (Individual assessment) [CO3]	10	The student does not show any interest in the project activities, and is a passive member.	The student show some interest and participates in some of the activities. However, the activities are mostly easy and superficial in nature.	The student shows very good interest in project, and takes up tasks and attempts to complete them. Shows excellent responsibility and team skills. Supports the other members well.	The student takes a leadership position and supports the other team members and leads the project. Shows clear evidence of leadership.
			(0 – 3 Marks)	(4 – 6 Marks)	(7 - 9 Marks)	(10 Marks)
1-e	Preliminary Analysis/ Modeling / Simulation/ Experiment / Design/ Feasibility study [CO1]	10	The team has not done any preliminary work with respect to the analysis/modeling/ simulation/experiment/design/feasibility study/ algorithm development.	The team has started doing some preliminary work with respect to the project. The students however are not prepared enough for the work and they need to improve a lot.	There is some evidence to show that the team has done good amount of preliminary investigation and design/ analysis/ modeling etc. They can improve further.	Strong evidence for excellent progress in the project. The team has completed the required preliminary work already and are poised to finish the phase I in an excellent manner. They have shown results to prove their progress.
			(0 – 3 Marks)	(4 – 6 Marks)	(7 - 9 Marks)	(10 Marks)

1-f	Documentation and presentation. (Individual & group assessment). [CO6]	5	<p>The team did not document the work at all. The project journal/diary is not presented. The presentation was shallow in content and dull in appearance. The individual student has no idea on the presentation of his/her part.</p>	<p>Some documentation is done, but not extensive. Interaction with the guide is minimal. Presentation include some points of interest, but overall quality needs to be improved. Individual performance to be improved.</p>	<p>Most of the project details were documented well enough. There is scope for improvement. The presentation is satisfactory. Individual performance is good.</p>	<p>The project stages are extensively documented in the report. Professional documentation tools like LaTeX were used to document the progress of the project along with the project journal. The documentation structure is well-planned and can easily grow into the project report.</p> <p>The presentation is done professionally and with great clarity. The individual's performance is excellent.</p>
			(0 – 1 Marks)	(2 – 3 Marks)	(4 Marks)	(5 Marks)
Total		30	Phase - I Final Evaluation Marks: 30			

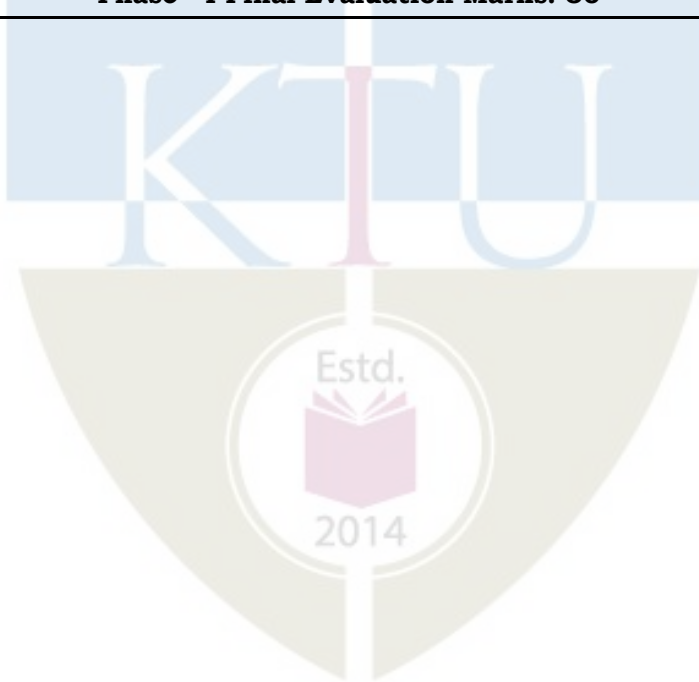

EVALUATION RUBRICS for PROJECT Phase I: Report Evaluation

Sl. No.	Parameters	Marks	Poor	Fair	Very Good	Outstanding
1-g	Report [CO6]	20	The prepared report is shallow and not as per standard format. It does not follow proper organization. Contains mostly Unacknowledged content. Lack of effort in preparation is evident.	Project report follows the standard format to some extent. However, its organization is not very good. Language needs to be improved. All references are not cited properly in the report.	Project report shows evidence of systematic documentation. Report is following the standard format and there are only a few issues. Organization of the report is good. Most of references are cited properly.	The report is exceptionally good. Neatly organized. All references cited properly. Diagrams/Figures, Tables and equations are properly numbered, and listed and clearly shown. Language is excellent and follows standard styles.
			(0 - 7 Marks)	(8 - 12 Marks)	(13 - 19 Marks)	(20 Marks)
Phase - I Project Report Marks: 20						



APJ ABDUL KALAM
TECHNOLOGICAL
UNIVERSITY

SEMESTER VII
PROGRAM ELECTIVE II



ECT413	OPTICAL FIBER COMMUNICATION	CATEGORY	L	T	P	CREDITS
		PEC	2	1	0	3

Preamble: This course aims to introduce the concepts of light transmission through optical fibers and introduce the working of optical components.

Prerequisite: Basic concepts of Solid State Devices

Course Outcomes: After the completion of the course the student will be able to

CO 1	Understand the working and classification of optical fibers in terms of propagation modes
CO 2	Solve problems of transmission characteristics and losses in optical fiber
CO 3	Explain the constructional features and the characteristics of optical sources and detectors
CO 4	Describe the operations of optical amplifiers
CO 5	Understand the concept of WDM, FSO and LiFi

Mapping of course outcomes with program outcomes

	PO 1	PO 2	PO 3	PO 4	PO 5	PO 6	PO 7	PO 8	PO 9	PO 10	PO 11	PO 12
CO 1	3	3	1									1
CO 2	3	3	2									1
CO 3	3	3	2									1
CO 4	3	3	1									1
CO 5	3	3	2									1

Assessment Pattern

Bloom's Category		Continuous Assessment Tests		End Semester Examination
		1	2	
Remember	K1	10	10	10
Understand	K2	30	30	60
Apply	K3	10	10	30
Analyse	K4			
Evaluate				
Create				

Mark distribution

Total Marks	CIE	ESE	ESE Duration
150	50	100	3 hours

Continuous Internal Evaluation Pattern:

Attendance	: 10marks
Continuous Assessment Test(2numbers)	: 25 marks
Assignment/Quiz/Course project	: 15marks

End Semester Examination Pattern: There will be two parts; Part A and Part B. Part A contain 10 questions with 2 questions from each module, having 3 marks for each question. Students should answer all questions. Part B contains 2 questions from each module of which student should answer any one. Each question can have maximum 2 sub-divisions and carry 14 marks.

Course Level Assessment Questions

Course Outcome 1 (CO1): Know the classification and working of optical fiber with different modes of signal propagation

1. Illustrate the types of optical fibers with refractive index profiles.
2. Define Photonic Crystal Fibers and list the types.
3. What is the necessity of cladding for an optical fiber?

Course Outcome 2 (CO2): Understand the transmission characteristics and losses in optical fiber

1. Describe the various attenuation losses incurred by light signal while transmitting through a fiber.
2. What is meant by group velocity dispersion?
3. An optical fiber has an attenuation coefficient of 0.5dB/km at 1310nm. Find the optical power at 25km if 500 μ W of optical power is launched into the fiber.

Course Outcome 3 (CO3): Describe the constructional features and the characteristics of optical sources and detectors

1. What is a heterojunction? How it increases the radiance and efficiency of LEDs?
2. Draw the basic block diagram of an optical receiver and explain.

Course Outcome 4 (CO4): Describe the performance of optical amplifiers

1. What are salient features of semiconductor optical amplifiers?
2. Explain the amplification mechanism with energy level diagram in an EDFA.

Course Outcome 5 (CO5): Know the concept of WDM, FSO and LiFi

1. What are the underlying principles of the WDM techniques?
2. Explain in detail diffraction gratings.
3. Write a note on optical Add / Drop multiplexers.

SYLLABUS

Module 1:

Optical fiber Communications: The general system, Advantages of optical fiber communication, Optical fiber waveguides: Ray theory transmission, Modes in planar guide, Phase and group velocity
Fibres: Types and refractive index profiles, Step index fibers, Graded index fibers, Single mode fibers, Cutoff wavelength, Mode field diameter, effective refractive index. Fibre materials, photonic crystal fibre, index guiding PCF, photonic band-gap fibres, fibre cables.

Module 2:

Transmission characteristics of optical fiber: Attenuation, Material absorption losses, Linear scattering losses, Nonlinear scattering losses, Fiber bend loss, Dispersion, Chromatic dispersion, Intermodal dispersion: Multimode step index fiber.

Optical Fiber Connectors: Fiber alignment and joint loss, Fiber splices, Fiber connectors, Fiber couplers.

Module 3:

Optical sources: LEDs and LDs, structures, characteristics, modulators using LEDs and LDs. coupling with fibres, noise in Laser diodes, Amplified Spontaneous Emission noise, effects of Laser diode noise in fibre communications

Optical detectors: Types and characteristics, structure and working of PIN and AP, noise in detectors, comparison of performance. Optical receivers, Ideal photo receiver and quantum limit of detection.

Module 4:

Optical Amplifiers: basic concept, applications, types, doped fibre amplifiers, EDFA, basic theory, structure and working, Semiconductor laser amplifier, Raman amplifiers, TDFA, amplifier configurations, performance comparison.

Module 5:

The WDM concept, WDM standards, WDM components, couplers, splitters, Add/ Drop multiplexers, gratings, tunable filters. Introduction to free space optics, LiFi technology and VLC. Optical Time Domain Reflectometer (OTDR) – fault detection length and refractive index measurements.

Text Books

1. Gerd Keiser, Optical Fiber Communications, 5/e, McGraw Hill, 2013.
2. Mishra and Ugale, Fibre optic Communication, Wiley, 2013.

Reference Books

1. Chakrabarthy, Optical Fibre Communication, McGraw Hill, 2015.
2. Hebbar, Optical fibre communication, Elsevier, 2014
3. John M Senior- Optical communications, 3/e, Pearson, 2009.
4. Joseph C. Palais, Fibre Optic Communications, 5/e Pearson, 2013.
5. Keiser, Optical Communication Essentials (SIE), 1/e McGraw Hill Education New Delhi, 2008.

Course Contents and Lecture Schedule

No	Topic	No. of Lectures
1	Optical fiber Communications	(8)
1.1	The general system, Advantages of optical fiber communication	1
1.2	Optical fiber waveguides: Ray theory transmission	1
1.3	Modes in planar guide, Phase and group velocity	1
1.4	Fibres: Types and refractive index profiles, Step index fibers, Graded index fibers, Single mode fibers	2
1.5	Cutoff wavelength, Mode field diameter, effective refractive index	1
1.6	Fibre materials, photonic crystal fibre, index guiding PCF, photonic band-gap fibres, fibre cables.	2
2	Transmission characteristics of optical fiber:	(7)
2.1	Attenuation, Material absorption losses	1
2.2	Linear scattering losses	1
2.3	Nonlinear scattering losses, Fiber bend loss	1
2.4	Dispersion, Chromatic dispersion, Intermodal dispersion: Multimode step index fiber	2
2.5	Optical Fiber Connectors: Fiber alignment and joint loss	1
2.6	Fiber splices, Fiber connectors, Fiber couplers	1
3	Optical sources and detectors:	(8)
3.1	LEDs and LDs, structures, characteristics, modulators using LEDs and LDs	2
3.2	coupling with fibres, noise in Laser diodes	1
3.3	Amplified Spontaneous Emission noise, effects of Laser diode noise in fibre communications	1
3.4	Optical detectors: Types and characteristics, structure and working of PIN and AP	2
3.5	noise in detectors, comparison of performance	1
3.6	Optical receivers, Ideal photo receiver and quantum limit of detection.	1
4	Optical Amplifiers:	(6)
4.1	basic concept, applications, types	1
4.2	doped fibre amplifiers, EDFA, basic theory, structure and working	2
4.3	Semiconductor laser amplifier	1
4.4	Raman amplifiers, TDFA	1
4.5	amplifier configurations, performance comparison	1
5	The WDM concept	(6)
5.1	WDM standards, WDM components	1
5.2	couplers, splitters, Add/ Drop multiplexers	1
5.3	gratings, tunable filters	1
5.4	Introduction to free space optics, LiFi technology and VLC	1

5.5	Optical Time Domain Reflectometer (OTDR) – fault detection length and refractive index measurements.	2
	Total	35

Model Question paper**APJ ABDUL KALAM TECHNOLOGICAL UNIVERSITY**

SEVENTH SEMESTER B.TECH DEGREE EXAMINATION, (Model Question Paper)

Course Code: ECT413**Program: Electronics and Communication Engineering****Course Name: Optical Fiber Communication**

Max.Marks: 100

Duration: 3Hours

PART- A

Answer ALL Questions. Each Carries 3 mark.

- | | |
|--|----|
| 1. Define acceptance angle and critical angle. | K1 |
| 2. What is the necessity of cladding for an optical fiber? | K3 |
| 3. What is meant by group velocity dispersion? | K2 |
| 4. Explain intermodal dispersion? | K2 |
| 5. Differentiate between spontaneous and stimulated emission. | K1 |
| 6. Draw the three key transition process involved in LASER action. | K1 |
| 7. Compare EDFA and TDFA. | K2 |
| 8. What is the principle of Raman amplifiers? | K2 |
| 9. Define FSO concept. List the advantages. | K2 |
| 10. Write short note on LiFi technology. | K2 |

PART – B

Answer one question from each module; each question carries 14 marks.

Module – I

11. a)	With block diagram explain a general light wave system. What are the advantages of optical communication?	7	CO1	K2
11. b)	i) Define Photonic Crystal Fibers . ii) Consider an optical fiber of 50 μm diameter, core index $n_1 = 1.5$, and cladding index $n_2 = 1.49$ for operation at $\lambda = 1.31 \mu\text{m}$. How many modes does this fiber support?	7	CO1	K2
OR				
12.a)	Illustrate the types of optical fibers with refractive index profiles.	6	CO1	K2
12.b)	Explain the following : (i) Acceptance angle (ii) Numerical aperture	8	CO1	K2

	If for a given optical fiber the refractive index of cladding and core are 1.45 and 1.47 respectively, calculate the numerical aperture and angle of acceptance in air.			
--	---	--	--	--

Module – II

13. a)	Explain macro bending and micro bending losses with a neat diagram.	10	CO2	K2
13. b)	An optical fiber has an attenuation coefficient of 0.5dB/km at 1310nm. Find the optical power at 25km if 500 μ W of optical power is launched into the fiber.	4	CO2	K3
	OR			
14.a)	Describe the various attenuation losses incurred by light signal while transmitting through a fiber.	9	CO2	K2
14.b)	Given an optical fiber of 50 μ m diameter, core index of 1.5, and cladding index 1.49 for operation at $\lambda = 1.31 \mu$ m, What would be the pulse spread due to modal dispersion over a distance of 10 km?	5	CO2	K2

Module-III

15 a)	With neat sketch explain the working of pin photodiode and APD	10	CO3	K2
15 b)	What is meant by responsivity? How it is related to quantum efficiency?	4	CO3	K3
	OR			
16a	What is a heterojunction? How it increases the radiance and efficiency of LEDs?	7	CO3	K3
16b	Draw the basic block diagram of an optical receiver and explain.	7	CO3	K2

Module-IV

17 a)	Explain the amplification mechanism with energy level diagram in an EDFA.	8	CO4	K2
17 b)	Compare the performance of different optical amplifiers	6	CO4	K2
OR				
18 a)	Explain the working of semiconductor optical amplifiers. What are salient features of semiconductor optical amplifiers?	7	CO4	K2
18 b)	What are different amplifier configurations? Explain the basic working principle of optical amplifiers.	7	CO4	K2

Module-V

19 a)	With neat sketch explain WDM scheme.	7	CO5	K2
19 b)	Illustrate the working principle of diffraction gratings.	7	CO5	K2
OR				
20 a)	Explain with block diagram the working of optical add / drop multiplexer. Explain why it is required in optical communication system.	7	CO5	K2
20 b)	How does an OTDR works? Explain the fault detection and refractive index measurement.	7	CO5	K2

ECT423	COMPUTER NETWORKS	CATEGORY	L	T	P	CREDIT
		PEC	2	1	0	3

Preamble: The course aims to expose students to computer networks taking a top-down approach of viewing from the layer of user applications and zooming into link layer protocols. The principles of various protocols used in every layer are studied in detail. A brief introduction to mathematical modelling of queues with an application to a single example is included.

Prerequisite: MAT 204 Probability, Random Process and Numerical Methods

Course Outcomes: After the completion of the course the student will be able to

CO1 K2	Describe the protocols used in web and email applications.
CO2 K4	Analyse problems pertaining to reliable data transfer, flow control and congestion over a TCP network.
CO3 K3	Apply Dijkstra's algorithm and distance-vector algorithm in the context of routing over computer networks.
CO4 K4	Analyze the performance of collision avoidance algorithms in random access protocols such as ALOHA.
CO5 K4	Analyze the delay performance of an ARQ system using standard queueing models.

Mapping of course outcomes with program outcomes

	PO 1	PO 2	PO 3	PO 4	PO 5	PO 6	PO 7	PO 8	PO 9	PO 10	PO 11	PO 12
CO 1	3	3	3									2
CO 2	3	3	3									2
CO 3	3	3	3									2
CO 4	3	3	3									2
CO 5												

Assessment Pattern

Bloom's Category		Continuous Assessment Tests		End Semester Examination
		1	2	
Remember				
Understand	K2	10	10	30
Apply	K3	20	20	40
Analyse	K4	20	20	30
Evaluate				
Create				

Mark distribution

Total Marks	CIE	ESE	ESE Duration
150	50	100	3 hours

Continuous Internal Evaluation Pattern:

Attendance	: 10 marks
Continuous Assessment Test (2 numbers)	: 25 marks
Assignment/Quiz/Course project	: 15 marks

End Semester Examination Pattern: There will be two parts; Part A and Part B. Part A contain 10 questions with 2 questions from each module, having 3 marks for each question. Students should answer all questions. Part B contains 2 questions from each module of which student should answer any one. Each question can have maximum 2 sub-divisions and carry 14 marks. Mark patterns are as per the syllabus with 60 % for theory and 40% for logical/numerical problems, derivation and proof.

Course Level Assessment Questions

Course Outcome 1 (CO1): Describe the protocols used in web and email applications.

1. Describe the HTTP message format
2. Compare and contrast two application layer protocols SMTP and HTTP

Course Outcome 2 (CO2): Analyse problems pertaining to reliable data transfer, flow control and congestion over a TCP network.

1. Why is it that voice and video traffic is often sent over TCP rather than UDP in today's Internet?
2. Suppose two TCP connections are present over some bottleneck link of rate R bps. Both connections have a huge file to send (in the same direction over the bottleneck link). The transmissions of the files start at the same time. What transmission rate would TCP like to give to each of the connections?

Course Outcome 3 (CO3): Apply Dijkstra's algorithm and distance-vector algorithm in the context of routing over computer networks.

1. Consider the following network. Compute the shortest-path from the node D to all other nodes using Dijkstra's shortest path algorithm. (Numbers indicated shows the link costs).

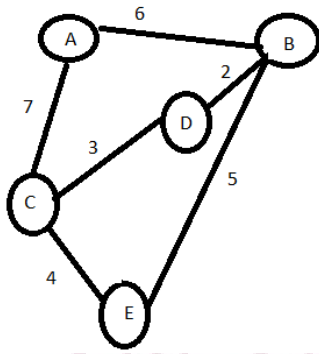

2. Consider a router that interconnects three subnets: Subnet 1, Subnet 2, and Subnet 3. Suppose all of the interfaces in each of these three subnets are required to have the prefix 223.1.17/24. Also suppose that Subnet 1 is required to support at least 60 interfaces, Subnet 2 is to support at least 90 interfaces, and Subnet 3 is to support at least 12 interfaces. Provide three network addresses (of the form a.b.c.d/x) that satisfy these constraints.

Course Outcome 4 (CO4):Analyze the performance of link-layer protocols in general, random access protocols in particular in terms of efficiency and collision avoidance capability.

1. Describe how slotted ALOHA achieves multiple access.
2. Distinguish between TDM, FDM and random access.

Course Outcome 5 (CO5):Analyze the delay performance of an ARQ system using standard queueing models.

1. Consider a network where packets arrive via N different nodes with different arrive rates. Illustrate the use of Little's law in this scenario to calculate the average packet delay inside the network.
2. Customers arrive in a restaurant at a rate of 5 per minute, and wait to receive their order for an average of 5 minutes. Customers eat in the restaurant with a probability of 0.5, and carry their order out without eating with probability 0.5. What is the average number of customers in the restaurant?

ELECTRONICS & COMMUNICATION ENGINEERING
SYLLABUS

Module	Course contents	Hours
I	<p>Components of computer networks Components of computer network, Applications of computer network – the Internet, Definition of protocol. Protocol standardization.</p> <p>Network edges, Network core and Network links Client and server hosts, connectionless and connection-oriented services provided to hosts, circuit-switched versus packet-switched network cores, FDM, TDM versus statistical multiplexing, Datagram versus Virtual-circuit networks. Access and physical media.</p> <p>Delay and loss in packet-switched networks Types of delay, Packet loss. Layered Architecture: Protocol layering, Internet protocol stack, Message encapsulation.</p> <p>Application Layer Communication between processes, Web application: HTTP, Message format, Email application: SMTP, Message format, MIME, POP3, IMAP and Web-based email. Domain Name System (DNS)</p>	8
II	<p>Transport Layer Multiplexing and demultiplexing: connectionless and connection-oriented. UDP. Protocols for reliable data transfer: ARQ protocols, stop-and-wait protocol, alternating-bit protocol, Go-back-N, Selective Repeat.</p> <p>TCP Connection, segment structure, RTT estimate, Flow control.</p> <p>Congestion Control General approaches. TCP congestion control.</p>	7
III	<p>Network Layer Datagram versus virtual-circuit network service, Router architecture, IPv4: datagram format, addressing, address assignment – manual and DHCP, NAT. ICMP. IPv6.</p> <p>Routing Algorithms Link-State (Dijkstra's) Algorithm, Distance-vector algorithm. Routing in Internet – RIP, OSPF, BGP. Broadcast and Multicast.</p>	7
IV	<p>Link Layer Services of link layer, Error detection and correction – checksum, CRC. Multiple access protocols – Channel partitioning, random access, taking-turns. ALOHA – pure and slotted, efficiency, CSMA, CSMA/CA, CSMA/CD. Link layer addressing: MAC address, ARP, DHCP. Ethernet. Link virtualization: ATM, MPLS</p>	7

V	Wireless Networks IEEE 802.11 wireless LAN Queueing models in computer networks Little's theorem and examples. Review of Poisson process. M/G/1 Queue. Delay analysis of Go-Back-N ARQ system.	8
---	---	---

Text Books

1. James F. Kurose, Keith W. Ross, Computer Networking: A Top-Down Approach Featuring the Internet, 3rd edition, Pearson
2. D. Bertsekas, R.G. Gallager, Data Networks, Prentice Hall

Reference Books

1. Larry L. Peterson, Bruce S. Davie, Computer Networks – A Systems Approach, Morgan Kaufman
2. N. Abramson, F. Kuo, Computer Communication Networks, Prentice Hall
3. A. S. Tanenbaum, D. J. Wetherall, Computer Networks, Pearson
4. A. Kumar, D. Manjunath, J. Kuri, Communication Networking – An Analytical Approach, Morgan Kaufman Series.

Course content and Lecture plan

No	TOPIC	No of Lectures
MODULE 1		
1.1	Components of computer networks, Applications, Protocol, Protocol standardization	1
1.2	Hosts, connectionless and connection-oriented, circuit-switching versus packet-switching in network core design, FDM, TDM versus statistical multiplexing,	1
1.3	Datagram versus Virtual-circuit networks. Examples of access networks, and examples of physical media.	1
1.4	Types of delay, Packet loss.	1
1.5	Layered Architecture, Protocol layering, Internet protocol stack, Message encapsulation.	1
1.6	Communication between processes, HTTP, Message format	1
1.7	Email application: SMTP, Message format, MIME, POP3, IMAP and Web-based email.	1
1.8	Domain Name System (DNS)	1
MODULE II		
2.1	Services of transport layer, Multiplexing and demultiplexing. Connectionless and connection-oriented transport. UDP.	1
2.2	Protocols for reliable data transfer: ARQ protocols, stop-and-wait protocol, alternating-bit protocol, Go-back-N, Selective Repeat.	3

2.3	TCP Connection, TCP segment, RTT, Flow control.	1
2.4	Congestion, Congestion control. TCP congestion control.	2
MODULE III		
3.1	Services of Network Layer, Recap of Datagram versus virtual-circuit network service, Router.	1
3.2	IPv4 addressing, Address assignment – manual and DHCP, NAT. ICMP. IPv6.	2
3.3	Link-State (Dijkstra's) Algorithm, Distance-vector algorithm.	2
3.4	Routing in Internet – RIP, OSPF, BGP. Distinction between Broadcast and Multicast routing.	2
MODULE IV		
4.1	Services of link layer, Parity checks, checksum, CRC.	1
4.2	Multiple access protocols – Channel partitioning, random access, taking-turns.	1
4.3	ALOHA – pure and slotted, efficiency, CSMA, CSMA/CA, CSMA/CD.	2
4.4	Link layer addressing: MAC address, ARP, DHCP.	1
4.5	Ethernet	1
4.6	Link virtualization: ATM, MPLS	1
MODULE V		
5.1	IEEE 802.11 wireless LAN	1
5.2	Mathematical modeling of queues/buffers.	1
5.3	Little's theorem and examples.	2
5.4	Review of Poisson process. M/G/1 Queue	1
5.5	Delay analysis of Go-Back-N ARQ system.	3

Simulation Assignments

Assignment 1:

1. Understanding protocols using Wireshark.
2. Wireshark is a standard network packet analyzer tool which can be used to analyze how the different protocol layers work (by adding headers and other meta information) to an application layer message.
3. Students can download Wireshark for their OS from <https://www.wireshark.org/download.html>
4. Sample packet traces can be obtained from <https://wiki.wireshark.org/SampleCaptures> or <https://gitlab.com/wireshark/wireshark/-/wikis/SampleCaptures>. Examples such as TCP, DHCP, DNS can be viewed.
5. https://gaia.cs.umass.edu/kurose_ross/wireshark.php

Assignment 2: (requires Python/Matlab)

1. Programming/Implementation of Dijkstra's and distance vector algorithm for shortest path on a graph.
2. Representation of networks in a programming language – Students can use NetworkX library in Python for this.
3. Generation of random graphs (students can use inbuilt functions of NetworkX – see for example <https://networkx.org/documentation/stable/reference/generators.html>)
4. Visualization of the generated graphs can be done using <https://networkx.org/documentation/stable/reference/drawing.html>
5. Use inbuilt shortest path functions to obtain a baseline to test self-written code https://networkx.org/documentation/stable/reference/algorithms/shortest_paths.html)
6. Implementation of Dijkstra's algorithm (see https://en.wikipedia.org/wiki/Dijkstra%27s_algorithm)
7. Implementation of Bellman Ford's algorithm (https://en.wikipedia.org/wiki/Distance-vector_routing_protocol)
8. Compare your answers with that of the inbuilt functions.
9. Do the assignment following the instructions here:
https://media.pearsoncmg.com/aw/aw_kurose_network_3/labs/lab6/lab6.html

Assignment 3: (understanding TCP)

1. Fully fledged simulation using NS3 can be given as a demonstration by the instructor https://www.cse.iitb.ac.in/~mythili/teaching/cs224m_autumn2017/tcpsimpa/index.html
2. Do the assignment following the instructions here:
https://media.pearsoncmg.com/aw/aw_kurose_network_3/labs/lab5/lab5.html
3. Do the assignment following the instructions here:
https://media.pearsoncmg.com/ph/esm/ecs_kurose_compnetwork_8/cw/#interactiveanimations
4. Do the assignment following the instructions here:
https://media.pearsoncmg.com/ph/esm/ecs_kurose_compnetwork_8/cw/content/interactiveanimations/tcp-congestion/index.html

Assignment 4: (basic queueing model and Little's law)

1. Assignment 4 in the attached collection is a good to understand Little's law.
https://drive.google.com/file/d/1CXauy0ehYno1ih6Zwllc_2XFLLe7cH6s/view

2. Do the assignment following the instructions here:

https://media.pearsoncmg.com/ph/esm/ecs_kurose_compnetwork_8/cw/content/interactiveanimations/queuing-loss-applet/index.html

Model Question paper

APJ ABDUL KALAM TECHNOLOGICAL UNIVERSITY

VII SEMESTER B. TECH DEGREE EXAMINATION, (Model Question Paper)

Course Code: ECT423

Course Name: COMPUTER NETWORKS

Max. Marks: 100

Duration: 3 Hours

PART A		
Answer all questions, each carries 3 marks		
1	Compare and contrast circuit switching and packet switching.	3
2	Explain the concept of FTTH internet access.	3
3	How does the process-to-process delivery service is achieved in transport layer?	3
4	Describe stop-and-wait protocol for reliable data transfer.	3
5	Give the basic blocks in router architecture.	3
6	What are the different error reporting messages in ICMP?	3
7	Explain the frame structure of Ethernet.	3
8	Compare and contrast different random-access protocols.	3
9	Customers arrive in a restaurant at a rate of 5 per minute, and wait to receive their order for an average of 5 minutes. Customers eat in the restaurant with a probability of 0.5, and carry their order out without eating with probability 0.5. What is the average number of customers in the restaurant?	3
10	Define M/G/1 queue.	3
PART B		
Answer any one full question from each module carries 14 marks.		
MODULE 1		
11(a)	How layered architecture helps in the efficient communication between hosts?	4
11(b)	Explain the functions performed by the layers in the internet protocol stack.	10
OR		

12(a)	Two hosts A and B separated by a distance of m meters, connected by a single link of rate R bps. The speed of propagation along the link is s m/s and host A is to send a packet of size L bits to host B. i) Express the propagation delay (Δ_{prop}) in terms of m and s . ii) Express the transmission delay (Δ_{trans}) in terms of L and R . iii) If $m=1000$ meters, $s=2.9 \times 10^8$ m/s, $L=100$ bits. Find the transmission rate of the link. (Assuming $\Delta_{prop} = \Delta_{trans}$)	8
12(b)	Describe any one of the mail access protocols.	6
MODULE II		
13(a)	Explain how TCP provides a flow control service to its applications.	5
13(b)	Compare and contrast TCP and UDP. Also explain the TCP segment structure.	9
OR		
14(a)	Host A and B are communicating over a TCP connection, and Host B has already received from A all bytes up through byte 248. Suppose Host A then sends two segments to Host B back-to-back. The first and second segments contain 40 and 60 bytes respectively. In the first segment, the sequence number is 249, the source port number is 503, and the destination port number is 80. Host B sends an acknowledgement whenever it receives a segment from Host A. i) In the second segment, sent from Host A to B, what are the sequence number, source port number, and destination port number? ii) If the second segment arrives before the first segment, in the acknowledgement of the first arriving segment. What is the acknowledgement number? iii) If the first segment arrives before the second segment, in the acknowledgement of the first arriving segment, what is the acknowledgement number, the source port number, and the destination port number?	7
14(b)	With the help of a neat diagram explain the operation of selective repeat ARQ.	7
MODULE III		
15(a)	Explain the datagram format in IPv4	7
15(b)	Describe the Internet's address assignment strategy using classless interdomain routing.	7
OR		
16(a)	Describe the process of assigning IP address to a host in an organization using DHCP protocol.	5
16(b)	Consider the following network. Compute the shortest-path from the node D to all other nodes using Dijkstra's shortest path algorithm. (Numbers indicated shows the link costs).	9

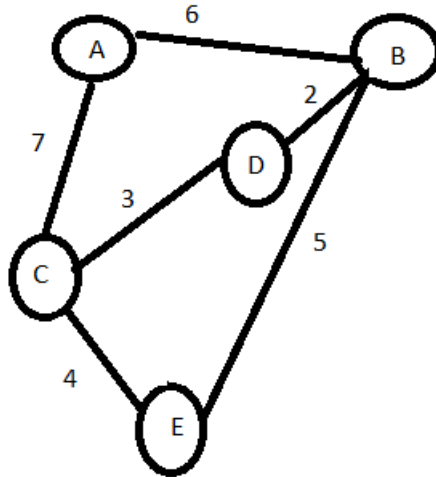
**MODULE IV**

17(a)	Explain the multiple access protocol used in IEEE 802.3.	7
17(b)	Explain the error detection mechanism using CRC with an example.	7
OR		
18(a)	Derive the efficiency of slotted ALOHA.	7
18(b)	Explain how the physical address of a host is being mapped from its IP address using address resolution protocol.	7
MODULE V		
19(a)	State and prove Little's theorem.	7
19(b)	Explain the IEEE 802.11 MAC protocol.	7
OR		
20(a)	Derive an expression for the average packet delay in a Go-Back-N ARQ system.	7
20(b)	Describe how a wireless station associates with an access point (AP) as per IEEE 802.11 protocol.	7

ECT433	OPTO-ELECTRONIC DEVICES	CATEGORY	L	T	P	CREDIT
		PEC	2	1	0	3

Preamble: This course aims to develop an insight over the working principles and performance parameters of various optoelectronics devices used for optical networks and communication.

Prerequisite:ECT 201 Solid State Devices

Course Outcomes: After the completion of the course the student will be able to

CO 1	Understand physics of optical processes in semiconductors.
CO 2	Distinguish different optical sources used in optoelectronic applications.
CO 3	Analyse different types of photodetectors based on their performance parameters
CO 4	Explain various optical modulators and optoelectronic devices.
CO 5	Explain various optical devices used for optical communication.

Mapping of course outcomes with program outcomes

	PO 1	PO 2	PO 3	PO 4	PO 5	PO 6	PO 7	PO 8	PO 9	PO 10	PO 11	PO 12
CO 1	3	3	2									
CO 2	3	3	3		1							
CO 3	3	3	3		1							
CO 4	3	3	2	2	2	2						
CO 5	3	3	2	2	2	2						

Assessment Pattern

Bloom's Category	Continuous Assessment Tests		End Semester Examination
	1	2	
Remember	10	10	20
Understand	30	30	60
Apply	10	10	20
Analyse			
Evaluate			
Create			

Mark distribution

Total Marks	CIE	ESE	ESE Duration
150	50	100	3 hours

Continuous Internal Evaluation Pattern:

Attendance	: 10 marks
Continuous Assessment Test (2 numbers)	: 25 marks
Assignment/Quiz/Course project	: 15 marks

End Semester Examination Pattern:

There will be two parts; Part A and Part B. Part A contain 10 questions with 2 questions from each module, having 3 marks for each question. Students should answer all questions. Part B contains 2 questions from each module of which student should answer any one. Each question can have maximum 2 sub-divisions and carry 14 marks.

Course Level Assessment Questions

Course Outcome 1 (CO1): Understand physics of optical processes in semiconductors.

1. Explain radiative and non radiative recombination
2. Describe Band to Band Recombination
3. Explain various Light Production mechanisms

Course Outcome 2 (CO2): Distinguish different optical sources used in optoelectronic applications

1. Explain the principle of operation of LED and LASER .
2. Explain DFB and DBR LASERS

Course Outcome 3 (CO3): Analyse different types of photodetectors based on their performance parameters

1. Describe the characteristics of APD
2. Explain the different type of Noise and its effect in the performance of Photodetectors

Course Outcome 4 (CO4): Explain various optical modulators and optoelectronic devices.

1. Explain the principle of operation of Electro-Optic Modulators and Acousto-Optic Modulators.
2. Explain different types of solar cells and its characteristics

Course Outcome 5 (CO5): Explain various optical devices used for optical communication.

1. Explain Fiber Bragg Grating and its refractive index profile.
2. Describe Optical Bistable Devices. Explain various methods for achieving optical bistability



SYLLABUS

Module 1 – Fundamentals of Semiconductor Optoelectronics

Optical processes in semiconductors: electron-hole generation and recombination, Absorption, Auger recombination, Heat generation and dissipation, Heat sources. Various light production mechanisms, Indirect band gap materials, Semiconductors used for optical Applications, Basic principle of LED and LASER, Spontaneous emission and Stimulated Emission, Coherence of sources.

Module 2 – Optical Sources

Construction and Operation of LEDs, Heterojunctions, Surface Emitter and Edge Emitter LEDs, Characteristics of LEDs, LASERS, Threshold Condition for lasing, Line Broadening Mechanisms, Fabry-Perot Lasers, Distributed Feedback (DFB) Lasers, Distributed Bragg Reflector (DBR) Lasers, Vertical Cavity Surface Emitting Lasers (VCSELs), In-Fibre Lasers.

Module 3 – Optical Detectors

Principle of Photo Detection, Working of LDR, PN diode, PIN diode, Avalanche Photodiode (APD), Characteristics of APD, Resonant Cavity Photo detector, Photo Transistor, Quantum efficiency, Responsivity, Noise in Photo detectors, Thermal Noise, Dark Current, Shot Noise, Quantum limit of Optical Detection.

Module 4 – Optoelectronic Devices and Modulators

Optoelectronic ICs, Advantages, Liquid Crystal Display, Structure, TFT display, Structure, Polymer LED, Organic LED, Optical Modulators using PN junction, Electro-Optic Modulators, Acousto-Optic Modulators, Raman-Nath Modulators, Optical switching and Logic devices, Optical Memory.

Solar Cells: basic working principle, VI Characteristics, Different types of solar cells, Dye sensitized solar cells (DSSC), Perovskite Solar cells.

Module 5 – Optical Devices in Optoelectronic Networks

Introduction to optical components, Splitters and Couplers, Directional Couplers, Fiber Bragg Gratings, Multiplexers, Attenuators, Isolators, Circulators, Fixed Filters, Tunable Filters, Add Drop Multiplexers, Waveguide Grating Routers, Optical Cross Connects, Wavelength Convertors, Optical Bistable Devices.

Text Book

1. Pallab Bhattacharya: Semiconductor Optoelectronic Devices, Pearson, 2009

References

1. Mark Csele, Fundamentals of Light Sources and Lasers, Wiley-Interscience, 2004
2. W.Koechner, M.Bass, Solid State Lasers, Springer, 2003
3. Yariv, Photonics Optical Electronics in modern communication, 6/e, Oxford University Press, 2006.
4. Harry J R Dutton, Understanding Optical Communications, IBM 1/e 1998
5. Alastair Buckley, Organic Light-Emitting Diodes, Woodhead, 2013
6. Stephen J Fonash, Solar Cell Device Physics, Elsevier 2/e, 2010

Course Contents and Lecture Schedule

No	Topic	No. of Lectures
1	Fundamentals of Semiconductor Optoelectronics	
1.1	Optical processes in semiconductors: electron-hole generation and recombination, Absorption.	1
1.2	Auger recombination, Heat generation and dissipation, Heat sources.	2
1.3	Various light production mechanisms	1
1.4	Indirect band gap materials, Semiconductors used for optical Applications	1
1.5	Basic principle of LED and LASER, Spontaneous emission and Stimulated Emission, Coherence of sources.	2
2	Optical Sources	
2.1	Construction and Operation of LEDs, Heterojunctios	1
2.2	Surface Emitter and Edge Emitter LEDs, Characteristics of LEDs	1
2.3	LASERs, Threshold Condition for lasing, Line Broadening Mechanisms	1
2.4	Fabry-Perot Lasers, Distributed Feedback(DFB) Lasers	1
2.5	Distributed Bragg Reflector (DBR) Lasers, Vertical Cavity Surface Emitting Lasers (VCSELs), In-Fibre Lasers.	2
3	Optical Detectors	
3.1	Principle of Photo Detection, Working of LDR, PN diode, PIN diode	1
3.2	Avalanche Photodiode (APD), Characteristics of APD	1
3.3	Resonant Cavity Photo detector, Photo Transistor	1
3.4	Quantum efficiency, Responsivity	1
3.5	Noise in Photo detectors, Thermal Noise, Dark Current, Shot Noise, Quantum limit of Optical Detection	2
4	Optoelectronic Devices and Modulators	
4.1	Optoelectronic ICs, Advantages	1
4.2	Liquid Crystal Display, Structure, TFT display, Structure	1
4.3	Polymer LED, Organic LED, Optical Modulators using PN junction	1
4.4	Electro-Optic Modulators, Acousto-Optic Modulators, Raman-Nath Modulators	2
4.5	Optical switching and Logic devices, Optical Memory	2
4.6	Solar Cells: basic working principle, VI Characteristics, Different types of solar cells	1
4.7	Dye sensitized solar cells (DSSC), Perovskite Solar cells	1
5	Optical Devices in Optoelectronic Networks	
5.1	Introduction to optical components, Splitters and Couplers,	1
5.2	Directional Couplers, Fiber Bragg Gratings, Multiplexers, Attenuators,	3

	Isolators, Circulators, Fixed Filters, Tunable Filters	
5.3	Add Drop Multiplexers, Waveguide Grating Routers, Optical Cross Connects	2
5.4	Wavelength Convertors, Optical Bistable Devices	1

Model Question Paper

APJ ABDUL KALAM TECHNOLOGICAL UNIVERSITY

MODEL QUESTION PAPER

ECT433 OPTO-ELECTRONIC DEVICES

Time: 3 hours

Max. Marks:100

PART A

Answer all questions. Each question carries 3 marks.

1. State the differences between Spontaneous emission and Stimulated emission.
2. Find the wavelength of light emitted by GaAs LED. Take band gap of GaAs to be 1.44eV at 300K
3. Explain surface emitter LED.
4. Explain any one line broadening mechanism in LASER Sources.
5. Calculate the photo current generated for an incident optical signal strength 600 nW on a PIN photodiode with responsivity 7.5 A/W
6. What is meant by dark current?
7. What is electro-optic effect?
8. Discuss the principle of optical memory.
9. List the different types of Wavelength division multiplexers and demultiplexers used of optical field access.
10. Explain the working principle of circulators.

PART B

MODULE - 1

- | | | |
|----|--|---|
| 11 | a Distinguish between radiative and non-radiative recombinations | 7 |
| | . | |
| | b Briefly explain what is meant by coherence of optical sources | 7 |
| | . | |
| OR | | |
| 12 | a Discuss the various light production mechanisms in materials | 7 |
| | . | |

- b Explain the basic principle of LED. 7

MODULE - 2

- 13 a With the help of a suitable diagram, explain the working principle of DFB Laser. 9

- b List the various features and characteristics of LEDs 5

OR

- 14 a With neat diagram, explain the principle of Surface Emitting LEDs and compare its features with edge emitting LEDs. 6

- b .A Light Emitting Diode gives $500\mu\text{w}$ output power when minority carrier lifetime is 4ns . Determine the output optical power when LED is modulated with 50MHz frequency with rms current equal to same dc current 8

MODULE - 3

- 15 a. Explain various noise mechanisms in optical detectors 5

- b. Discuss the construction and working principle of PIN photodiode. 9

OR

- 16 a. Elucidate different techniques commonly used for measuring high speed response of photodetectors 6

- b. Calculate the photocurrent density of a Si p-i-n photodiode with $8\ \mu\text{m}$ i-region when $0.87\ \mu\text{m}$ light power density $0.5\text{W}/\text{cm}^2$ is incident upon it. It is assumed the top illuminated surface is coated with anti-reflection coating. Given that absorption coefficient at $0.87\ \mu\text{m}$ is 600. 8

MODULE - 4

- 17 a. What is meant by acousto-optic effect? Explain Raman-Nath modulator. 9

- b. Explain the working principle of organic LEDs. 5

OR

- 18 a. Write a short note on Perovskite Solar cells 5

- b. Describe the structure of Polymer LED. List the advantages and disadvantages of Polymer LED. 9

MODULE - 5

- 19 a. Discuss the principle of tunable filters. 8

- b. Explain the principle and working of waveguide grating routers 6

OR

- 20 a. Explain different types of fixed optical filters. 9

- b. Calculate the physical grating period required for FBG for rejecting $980\ \text{nm}$ optical signals. Take average refractive index of the core = 1.45 5

ECT443	INSTRUMENTATION	CATEGORY	L	T	P	CREDIT
		PEC	2	1	0	3

Preamble: This course aims to introduce the basic concepts of electronic measuring instruments for measuring physical variables using transducers and to familiarize the concepts of the control systems PLC,DCS and SCADA.

Prerequisite: Nil

Course Outcomes: After the completion of the course the student will be able to

CO 1	Interpret the basic concepts of measuring instruments, its classification, and selection criteria, static and dynamic characteristics.
CO 2	Understand the principle, construction and working of transducers for measuring physical variables.
CO 3	Comprehend the principle, construction and working of various electronic measuring instruments.
CO 4	Explain the hardware architecture for PLC, DCS and SCADA.
CO 5	Apply PLC programming for selected industrial processes.

Mapping of course outcomes with program outcomes

	PO1	PO2	PO3	PO 4	PO 5	PO 6	PO 7	PO 8	PO 9	PO10	PO11	PO12
CO 1	3	3										
CO 2	3	3	3									
CO 3	3	3	3									
CO 4	3	3										
CO 5	3	3	3									

Assessment Pattern

Bloom's Category	Continuous Assessment Tests		End Semester Examination
	1	2	
Remember	10	10	20
Understand	30	20	50
Apply	10	20	30
Analyse			
Evaluate			
Create			

Mark distribution

Total Marks	CIE	ESE	ESE Duration
150	50	100	3 hours

Continuous Internal Evaluation Pattern:

Attendance	:	10marks
Continuous Assessment Test (2numbers)	:	25 marks
Assignment	:	15marks

End Semester Examination Pattern: There will be two parts; Part A and Part B. Part A contain 10 questions with 2 questions from each module, having 3 marks for each question. Students should answer all questions. Part B contains 2 questions from each module of which student should answer any one. Each question can have maximum 2 sub-divisions and carry 14 marks.

Course Level Assessment Questions**Course Outcome 1 (CO1):** Basics of measuring instruments

1. Explain the difference between accuracy and precision.
2. With neat block diagram explain the functional elements of a measuring instrument.
3. Explain the following static characteristics of a measuring instruments in details :- Sensitivity, Resolution, Selectivity, Linearity

Course Outcome 2 (CO2): Basics of transducers

1. Explain the working of a piezoelectric transducer.
2. Explain the principle of Hall Effect. How a proximity sensor works on the basis of Hall Effect?
3. Explain the construction, working principle, application, advantages and disadvantages of LVDT.

Course Outcome 3 (CO3): Basics of Electronics measuring instruments

1. With neat block diagram explain the working of a DSO
2. Explain ramp type digital voltmeter
3. With neat sketch explain the working of a frequency counter

Course Outcome 4 (CO4): Basics of PLC, DCS, SCADA

1. Explain the hardware components of a DCS
2. What are the various Input Output devices connected to a PLC?
3. Explain in details the SCADA architecture

Course Outcome 5 (CO5): PLC Programming

1. Two motors are to be controlled in a sequence. The second motor starts 30 seconds after the starting of first motor by a push switch. Develop a PLC ladder diagram for the following

cases and describe the circuit.

Case (A): Only one motor operates at a time.

Case (B): Both the motor gets off together after 50 seconds.

Syllabus

Module 1

Introduction to measuring instruments

Generalized Configurations and Functional elements of Instrumentation systems, Need for Measurement Systems, Classification of Types of Measuring instruments. Static and Dynamic characteristics of measuring instruments. Sensors and Transducers: - Need, Classification and selection criteria.

Module 2

Transducer

Principles of operation, construction, theory, advantages and disadvantages, applications of-

Resistive Transducers: Potentiometers, strain gauges, (metallic and semi-conductor type), Resistance Thermometer, Thermistors.

Inductive Transducers: LVDT (Linear variable differential transformer).

Capacitive Transducers: various capacitive transducers based upon familiar equation of capacitance (capacitive microphone)

Active Transducers: Thermocouple, Piezo-electric transducer, Hall Effect transducer, Flow meter

Module 3

Electronic Measuring Instruments

Digital storage oscilloscope, Working principle and applications of waveform analyser, digital frequency meter, harmonic distortion meter, harmonic analyser, spectrum analyser and logic state analyser IEEE - 488 General Purpose Interface Bus (GPIB) Instruments with application. EMI, Grounding and Shielding

Module 4

PLC, DCS and SCADA

PLC Basics: An Overall looks at PLCs, General PLC Programming Procedures, Devices to which PLC Inputs and Outputs are connected.

Distributed Control System: Meaning and necessity of distributed control; hardware components of DCS; DCS software.

Introduction to SCADA: SCADA overview, SCADA Architecture – Monolithic, Distributed and Networked, SCADA Protocols- IEC 60870-5-101, DNP-3, Profibus, Modbus

Module 5**PLC Programming**

Basic PLC Programming : Programming ON/OFF Inputs, Creating Ladder diagrams, Register Basics, PLC Timers and Counters, PLC Arithmetic functions, Number comparison functions, Data handling Functions: Skip function and applications; master control relay function and applications; jump with non-return and return; data table, register and other move functions, PLC functions with BITS.

Text Book

1. Ernest Doebelin, Dhanesh N. Manik, 'Doebelin's Measurement Systems', McGraw Hill, 7th Edition, 2019
2. Kalsi HS, "Electronic Instrumentation," Tata McGraw Hill, Third Edition
3. John R Hackworth, Frederick D Hackworth, Jr, "Programmable Logic controllers Programming Methods and Applications", Pearson Education.

Reference

1. Sawhney AK, "Electrical and Electronics Measurements and Instrumentation," Dhanpat Rai and Sons
2. John W Webb, Ronald A. Reis, "Programmable Logic Controllers- Principles and applications", PHI , ND, 2006

Course Contents and Lecture Schedule

No	Topic	No. of Lectures
1	Introduction to measuring instruments	
1.1	Generalised Configurations and Functional elements of Instrumentation systems	1
1.2	Need for Measurement Systems, Classification of Types of Measuring instruments, Static and Dynamic characteristics of measuring instruments	3
1.3	Sensors and Transducers: - Need, Classification and selection criteria.	1
2	Transducers	
2.1	Principles of operation, construction, theory, advantages and disadvantages, applications of- Resistive Transducers: Potentiometers, strain gauges, (metallic and semi-conductor type), Resistance Thermometer, Thermistors.	3
2.2	Principles of operation, construction, theory, advantages and disadvantages, applications of- Inductive Transducers: LVDT (Linear variable differential transformer).	2
2.3	Principles of operation, construction, theory, advantages and disadvantages, applications of- Capacitive Transducers: various Capacitive transducers based upon familiar equation of capacitance (capacitive microphone)	2

2.4	Principles of operation, construction, theory, advantages and disadvantages, applications of-, Active Transducers: Thermocouple, Piezo-electric transducer, Hall effect transducer, Flow meter	2
3 Electronic Measuring Instruments		
3.1	Digital storage oscilloscope:- Working, Applications	1
3.2	Working principle and applications of waveform analyzer, digital frequency meter, harmonic distortion meter, harmonic analyser, spectrum analyser and logic state analyser	3
3.3	IEEE - 488 General Purpose Interface Bus (GPIB) Instruments with application	1
3.4	EMI, Grounding and Shielding	1
4 PLC,DCS,SCADA		
4.1	PLC Basics: An Overall looks at PLCs, General PLC Programming Procedures, Devices to which PLC Inputs and Outputs are connected.	2
4.2	Distributed Control System: Meaning and necessity of distributed control; hardware components of DCS; DCS software	2
4.3	Introduction to SCADA: SCADA overview, SCADA Architecture – Monolithic, Distributed and Networked, SCADA Protocols- IEC 60870-5-101, DNP-3, Modbus, Profibus	2
5 PLC Programming		
5.1	Basic PLC Programming : Programming ON/OFF Inputs, Creating Ladder diagrams, Register Basics	2
5.2	PLC Timers and Counters, PLC Arithmetic functions, Data handling Functions: Skip function and applications	3
5.3	master control relay function and applications; jump with non-return and return;	2
5.4	Data table, register and other move functions, PLC functions with BITS	2

Model Question Paper

A P J ABDUL KALAM TECHNOLOGICAL UNIVERSITY
EIGHTH SEMESTER B TECH DEGREE EXAMINATION
BRANCH: ELECTRONICS AND COMMUNICATION
COURSE: ECT443 INSTRUMENTATION

Time:3 Hrs.

Max. Marks:100

PART A*Answer All Questions*

- | | | |
|----|---|-----------|
| 1 | Explain the difference between accuracy and precision. | (3) K_2 |
| 2 | Compare transducer and sensor. | (3) K_2 |
| 3 | Explain the working of a piezoelectric transducer. | (3) K_2 |
| 4 | Differentiate between RTD and thermocouple. | (3) K_2 |
| 5 | Explain the need for grounding and shielding | (3) K_2 |
| 6 | What are the applications of a DSO? | (3) K_3 |
| 7 | What are the essential elements of a PLC system? | (3) K_2 |
| 8 | Explain any two applications of SCADA. | (3) K_2 |
| 9 | With suitable example explain latching in PLC Ladder logic | (3) K_3 |
| 10 | Draw the ladder diagram for the following logic functions.
(i) XOR (ii) NAND (iii) NOR | (3) K_3 |

PART B*Answer one question from each module. Each question carries 14 mark.***Module I**

- | | | |
|-------|--|-----------|
| 11(A) | With neat block diagram explain the functional elements of a measuring instrument. | (8) K_2 |
| 11(B) | Explain the parameters for selection of a transducer. | (6) K_2 |

OR

- | | | |
|-------|--|-----------|
| 12(A) | Explain the following static characteristics of a measuring instruments in details:- Sensitivity, Resolution, Selectivity, Linearity | (8) K_2 |
| 12(B) | How are transducers classified? | (6) K_2 |

Module II

- | | | |
|-------|---|-----------|
| 13(A) | Derive the expression for finding gauge factor of a strain gauge | (8) K_3 |
| 13(B) | Explain the principle of Hall effect. How a proximity sensor works on the basis of Hall effect? | (6) K_2 |

OR

- 14 Explain the construction , working principle, application, advantages and disadvantages of LVDT (14) K_2

Module III

- 15(A) With neat block diagram explain the working of a DSO (7) K_2
 15(B) Explain the working principle of a frequency analyzer (7) K_2

OR

- 16(A) With neat sketch explain the working of a frequency counter (8) K_2
 16(B) Explain the working principle of a Logic State analyzer (6) K_2

Module IV

- 17(A) Explain the hardware components of a DCS (8) K_2
 17(B) What are the various Input Output devices connected to a PLC? (6) K_2

OR

- 18(A) Explain in details the SCADA architecture (8) K_2
 18(B) Differentiate between Profibus and Modbus (6) K_2

Module V

- 19 Two motors are to be controlled in a sequence. The second motor starts 30 seconds after the starting of first motor by a push switch. Develop a PLC ladder diagram for the following cases and describe the circuit. (14) K_3
 Case (A): Only one motor operates at a time.
 Case (B): Both the motor gets off together after 50 seconds.

OR

- 20 Saw, Fan and oil pump all go ON when a start button is pressed. (14) K_3
 If the saw has operated less than 20s, the oil pump should go off when the saw is turned off and the fan is to run for an additional 5s after the shutdown of the saw.

If the saw has operated for more than 20s, the fan should remain on until reset by a separate fan reset button and the oil pump should remain on for an additional 10 s after the saw is turned off. Write a program that will implement this process.

ECT453	ERROR CONTROL CODES	CATEGORY	L	T	P	CREDIT
		PEC	2	1	0	3

Preamble: This course aims to give an insight into the various codes used for error control in data transmission

Course Outcomes: On completion of the course the student will be able to

CO 1 K3	Describe the principles of block codes, types and their bounds
CO 2 K3	Illustrate the principles of cyclic codes and Galois Fields, encoding and decoding of binary BCH codes and algorithms for finding the error location polynomial
CO 3 K3	Demonstrate encoding, decoding and error location of Reed Solomon codes and Reed Muller codes
CO 4 K3	Illustrate the encoding and decoding of Convolution Codes and Turbo Codes
CO 5 K3	Describe the encoding, decoding and applications of LDPC Codes
CO 6 K3	Discuss the concepts of polar codes and its applications in 5G

Mapping of course outcomes with program outcomes

	PO 1	PO 2	PO 3	PO 4	PO 5	PO 6	PO 7	PO 8	PO 9	PO 10	PO 11	PO 12
CO 1	3	3	2									2
CO 2	3	3	2									2
CO 3	3	3	2									2
CO 4	3	3	2									2
CO 5	3	3	2									2
CO 6	3	3	2									2

Assessment Pattern

Bloom's Category		Continuous Assessment Tests		End Semester Examination
		1	2	
Remember	K1	10	10	10
Understand	K2	20	20	20
Apply	K3	20	20	70
Analyse				
Evaluate				
Create				

Mark distribution

Total Marks	CIE	ESE	ESE Duration
150	50	100	3 hours

Continuous Internal Evaluation Pattern:

Attendance : 10 marks

Continuous Assessment Test (2 numbers) : 25 marks

Assignment/Quiz/Course project : 15 marks

End Semester Examination Pattern: There will be two parts; Part A and Part B. Part A contain 10 questions with 2 questions from each module, having 3 marks for each question. Students should answer all questions. Part B contains 2 questions from each module of which student should answer any one. Each question can have maximum 2 sub-divisions and carry 14 marks.

Course Level Assessment Questions

Course Outcome 1 (CO1): Describe the principles of block codes, types and their bounds

1. Define Code Rate, Hamming Distance and Error detection and correction capabilities of Block codes
2. Construct Hamming Codes for a given Generator Matrix
3. State and prove Gilbert Varshamov bound

Course Outcome 2 (CO2): Illustrate the principles of cyclic codes and Galois Fields, encoding and decoding of binary BCH codes and algorithms for finding the error location polynomial

1. Design a (n,k) cyclic code in systematic form using a given generator polynomial $g(X)$
2. Determine all the conjugacy classes in an extended GF with respect to a given GF
3. Describe the Chien search algorithm for finding the error locator polynomial for Binary BCH Codes

Course Outcome 3 (CO3): Demonstrate encoding, decoding and error location of Reed Solomon codes and Reed Muller codes

1. Differentiate between the BCH and Vandermonde viewpoints of Reed Solomon Codes
2. Explain Sudan's algorithm for decoding RS codes
3. Devise an encoding circuit for RM $(1, m)$ code

Course Outcome 4 (CO4): Illustrate the encoding and decoding of Convolution Codes and Turbo Codes

1. Construct an encoder, state diagram and trellis for a convolution encoder using a given generator polynomial.
2. Decode convolution codes using Viterbi decoder
3. Construct a Turbo encoder for a given generator polynomial

Course Outcome 5 (CO5): Describe the encoding, decoding and applications of LDPC Codes

1. Determine if a given matrix satisfies the conditions of the parity check matrix of an LDPC code.
2. Construct the Tanner graph for a given LDPC code. Determine the girth of the Tanner graph
3. Discuss the message passing decoding over binary erasure channels

Course Outcome 6 (CO6): Discuss the encoding, decoding and applications in 5G of polar codes

1. Explain the basic ideas of polarization
2. Discuss polarization of BEC channels
3. Explain how polar codes can be applied in 5G

SYLLABUS

Error Control Codes

Module 1: Block Codes and Bounds.

Error Control Coding – Relevance of error control codes in Communication System, concepts of Code rate, Hamming Distance, Minimum Distance, Error detecting and correcting capability.

Repetition Codes, Hamming Codes, Review of Groups, Fields, Vector Spaces. Linear Block Codes - Generator matrix, Parity Check Matrix. Dual Codes, Error Detection and Correction over hard output channels. Dual of binary Hamming codes. Maximum Likelihood Decoding

Simple bounds on block codes - Singleton bound, Hamming Bound, Gilbert-Varshamov bound. Maximum-distance-separable (MDS) codes.

Module 2: Cyclic Codes

Review of basic concepts of cyclic codes – generator matrix, parity-check matrix. Polynomial view point. Encoding, systematic encoding, syndrome decoding.

Galois Fields -- Irreducible and Primitive Polynomials, Primitive elements, Field extension, Conjugate elements and Minimal Polynomials. Cyclotomic cosets.

BCH Codes - Design, BCH Bound, Decoding BCH codes – Decoding BCH – the general outline, computation of the syndrome, error locator polynomial, Chien Search algorithm,

Finding the error locator polynomial. Berlekamp Massey Algorithm. Burst-error correction capability of BCH codes.

Module 3: Reed-Solomon and Reed-Muller Codes

Reed Solomon Codes – BCH code viewpoint. Vandermonde matrix view point. MDS property. Generalized Reed-Solomon codes. Application of BCH decoding algorithms to Reed-Solomon decoding. Sudan's algorithm for decoding. Use of RS codes in disks and cloud storage.

Reed Muller Codes, Encoding and decoding of RM (1, m) codes. Majority-logic decoding of Reed-Muller codes.

Module 4: Convolutional and Turbo Codes

Convolution Codes, State Diagram, Systematic Encoders, Decoding of Convolution Codes – Viterbi algorithm, Turbo Codes, Encoding parallel concatenated codes.

Module 5: LDPC and Polar Codes

Low Density Parity Codes, Construction, Tanner Graphs, Message passing decoding. Example of message passing decoding over binary erasure channels. Message passing of LLR and decoding over AWGN channels.

Polar Codes – Introduction, polarization of BEC channels, Polar transform and frozen bits. LDPC and Polar codes in 5G.

Textbooks and References

1. Shu Lin, D. J Costello Jr. Error Control Coding: Fundamentals and Applications, Prentice Hall
2. Ron M Roth, Introduction to Coding Theory, Cambridge University Press
3. Todd K. Moon, Error Correction Coding: Mathematical Methods and Algorithms, Wiley.
4. T. Richardson, R. Urbanke, Modern Coding Theory, Cambridge University Press
5. H. Pfister, A Brief Introduction to Polar Codes, Lec. Notes
6. O. Gazi, Polar Codes: A Non-Trivial Approach to Channel Coding, Springer, 2018.
7. A. Thangaraj, LDPC and Polar Codes in 5G Standard, NPTEL Course

Course Contents and Lecture Schedule

S.No	Topic	No. of Lectures
1	Module 1: Block Codes and Bounds.	
1.1	Error Control Coding – Relevance of error control codes in Communication System, concepts of Code rate, Hamming Distance, Minimum Distance, Error detecting and correcting capability.	2
1.2	Repetition Codes, Hamming Codes, Review of Groups, Fields, Vector Spaces. Linear Block Codes - Generator matrix, Parity Check Matrix. Dual Codes, Error Detection and Correction over hard output channels. Dual of binary Hamming codes. Maximum Likelihood Decoding	2
1.3	Simple bounds on block codes - Singleton bound, Hamming Bound, Gilbert-Varshamov bound. Maximum-distance-separable (MDS) codes.	2
2	Module 2: Cyclic Codes	
2.1	Review of basic concepts of cyclic codes – generator matrix, parity-check matrix. Polynomial view point. Encoding, systematic encoding, syndrome decoding.	2
2.2	Galois Fields -- Irreducible and Primitive Polynomials, Primitive elements, Field extension, Conjugate elements and Minimal Polynomials. Cyclotomic cosets.	2
2.3	BCH Codes - Design, BCH Bound, Decoding BCH codes – Decoding BCH – the general outline, computation of the syndrome, error locator polynomial, Chien Search algorithm, Finding the error locator polynomial. Berlekamp Massey Algorithm. Burst-error correction capability of BCH codes.	4
3	Module 3: Reed-Solomon and Reed-Muller Codes	
3.1	Reed Solomon Codes – BCH code viewpoint. Vandermonde matrix view point. MDS property. Generalized Reed-Solomon codes. Application of BCH decoding algorithms to Reed-Solomon decoding. Sudan's algorithm for decoding. Use of RS codes in disks and cloud storage.	4
3.2	Reed Muller Codes, Encoding and decoding of RM (1, m) codes. Majority-logic decoding of Reed-Muller codes.	3
4	Module 4: Convolutional and Turbo Codes	
4.1	Convolution Codes, State Diagram, Systematic Encoders, Decoding of Convolution Codes – Viterbi algorithm	4
4.2	Turbo Codes, Encoding parallel concatenated codes.	3
5	Module 5: LDPC and Polar Codes	

5.1	Low Density Parity Codes, Construction, Tanner Graphs, Message passing decoding. Example of message passing decoding over binary erasure channels. Message passing of LLR and decoding over AWGN channels.	4
5.2	Polar Codes – Introduction, polarization of BEC channels, Polar transform and frozen bits. LDPC and Polar codes in 5G.	3

Simulation Assignments

Using GAP,

- Determine if a given polynomial is reducible
- Generate Hamming codes, Reed Muller Codes
- Generate the Standard Array of a given code C
- Generate the generator matrix of a given code C
- Generate the parity check matrix of a given code C
- Determine the Hamming Distance and minimum distance of a given code C

Similar exercises may be given



Model Question paper**APJ ABDUL KALAM TECHNOLOGICAL UNIVERSITY****SEVENTH SEMESTER B. TECH DEGREE EXAMINATION, (Model Question Paper)****Course Code: ECT453****Course Name: ERROR CONTROL CODES**

Max. Marks: 100

Duration: 3 Hours

PART A

Answer ALL Questions. Each Carries 3 mark.

1	Generate all the code polynomials for the (7,4) Hamming Code generator polynomial $g(x) = 1+x+x^3$	K3
2	Define (a) MDS Code (b) Minimum Distance (c) Repetition Code	K1
3	Determine if x^5+x^3+1 is irreducible over GF (2)	K3
4	Illustrate the general outline for decoding BCH codes	K2
5	Prove that the minimum distance of an (n,k) RS code is n-k+1	K2
6	Construct the Generator matrix of a RM(1,3) code	K3
7	Describe a catastrophic encoder	K2
8	Discuss the applications of turbo codes in 5G	K2
9	Explain the method of construction of LDPC Codes	K2
10	Describe the applications of polar codes in 5G	K2
PART – B		
Answer one question from each module; each question carries 14 marks.		
Module - I		
11	Define and prove Hamming bound and Gilbert Varshamov bounds For the (7,4) Hamming code generator polynomial $g(x) = 1+x+x^3$, generate all possible code polynomials $c(x)$. Determine the parity check matrix $h(x)$ for this code. Calculate the minimum distance of the Hamming code generated	7
a.		CO1 K2
b.		7 CO1 K3
OR		
12	Consider a systematic block code whose parity check equations are: $p_1 = m_1+m_2+m_4$ $p_2 = m_1+m_3+m_4$ $p_3 = m_1+m_2+m_3$ $p_4 = m_2+m_3+m_4$ where m_i are the message digits and p_i are the check digits a) Find the generator matrix and parity check matrix for this code	14 CO1 K3

	b) How many errors can the code correct? c) Is the vector 10101010 a code word?	
	Module - II	
13 a	For a binary, narrow sense, triple error correcting BCH code of length 15, constructed using the polynomial x^4+x+1 (a) Compute a generator polynomial for this code (b) Determine the rate of the code (c) Construct the parity check matrix and generator matrix for this code	7 CO2 K3
b	Define and prove the BCH bound	7 CO2 K2
	OR	
14a	Construct the systematic encoder for cyclic codes and explain its working	7 CO2 K2
b	Describe the Chien search algorithm for BCH codes	7 CO2 K2
	Module - III	
15 a	Explain Sudan's algorithm for Reed Solomon Codes	7 CO3 K2
b	Differentiate between the BCH Viewpoint and Vandermonde viewpoints of Reed Solomon Codes	7 CO3 K2
	OR	
16	Form the generator matrix of the first order RM code RM (1,3) of length 8. What is the minimum distance of the code? Determine its parity check sums and devise a majority logic decoder for the code. Decode the received vector $r = (01000101)$	14 CO3 K3
	Module - IV	
17	For the $R=1/2$ convolution encoder with $G(x) = [1+x^2+x^3 \ 1+x+x^3]$ (a) Draw a hardware realization of the encoder (b) Determine the convolution generator matrix G (c) For the input sequence $m = [1,0,1,1,0,1,1]$ determine the coded output sequence (d) Draw the state diagram (e) Draw the trellis (f) Is this a catastrophic realization? Justify your answer	14 CO4 K2
	OR	
18 a.	Illustrate Turbo encoding without and with puncturing	7 CO4 K2
b.	Explain the Viterbi algorithm and the schematic of add compare select hardware	7

	implementation	CO4 K2
	Module - V	
19	<p>For the parity check matrix</p> $\begin{bmatrix} 1 & 1 & 0 & 1 & 0 & 0 & 0 \\ 0 & 1 & 1 & 0 & 1 & 0 & 0 \\ 0 & 0 & 1 & 1 & 0 & 1 & 0 \\ 0 & 0 & 0 & 1 & 1 & 0 & 1 \end{bmatrix}$ <p>a.</p> <p>(a) Construct the Tanner graph for the code (b) Determine the girth of the minimum girth cycle (c) Determine the number of cycles of length 6 (d) Determine a generator matrix for this code</p>	8 CO5 K3
b.	Explain message passing decoding of LDPC codes over binary erasure channels	6 CO5 K2
	OR	
20	a. Describe the basic ideas of polarization	6 CO6 K2
b.	Explain channel polarization for N=2 channel	8 CO6 K2

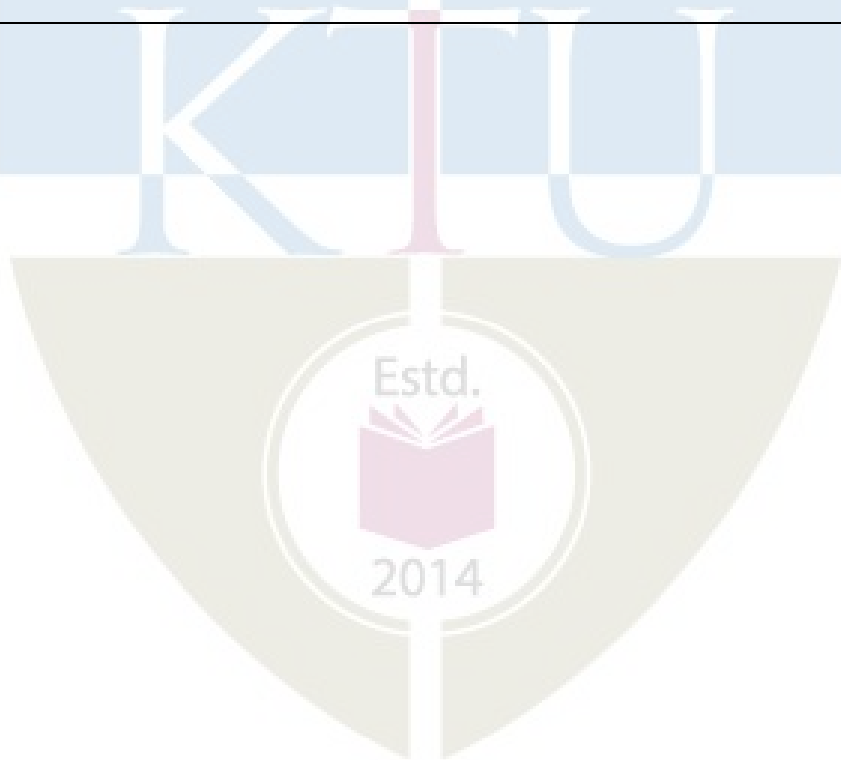

ECT463	MACHINE LEARNING	CATEGORY	L	T	P	CREDIT
		PEC	2	1	0	3

Preamble: This course aims to impart the fundamentals of machine learning techniques.

Prerequisite: MAT 101 Linear Algebra and Calculus

MAT 204 Probability, Random Process, and Numerical Methods

Course Outcomes: After the completion of the course the student will be able to

CO1 K2	Understand the basics of machine learning and different types.
CO2 K3	Differentiate regression and classification, apply Bayes' decision theory in classification
CO3 K3	Apply linear algebra and statistical methods in discriminant based algorithms
CO4 K2	Understand the basics of unsupervised learning and non-metric methods
CO5 K2	Understand ensemble methods, dimensionality reduction, evaluation, model selection.

Mapping of course outcomes with program outcomes

	PO1	PO 2	PO 3	PO 4	PO 5	PO 6	PO 7	PO 8	PO 9	PO1 0	PO11	PO12
CO 1	3											
CO 2	3	3	3	3	3							
CO 3	3	3	3	3	3							
CO 4	3											
CO 5	3			3	3							

Assessment Pattern

Bloom's Category		Continuous Assessment Tests		End Semester Examination
		1	2	
Remember				
Understand	K2	30	30	60
Apply	K3	20	20	40
Analyse				
Evaluate				
Create				

Mark distribution

Total Marks	CIE	ES E	ESE Duration
150	50	100	3 hours

Continuous Internal Evaluation Pattern:

Attendance	: 10 marks
Continuous Assessment Test (2 numbers)	: 25 marks
Assignment/Quiz/Course project	: 15 marks

End Semester Examination Pattern: There will be two parts; Part A and Part B. Part A contain 10 questions with 2 questions from each module, having 3 marks for each question. Students should answer all questions. Part B contains 2 questions from each module of which student should answer any one. Each question can have maximum 2 sub-divisions and carry 14 marks.

Course Level Assessment Questions

Course Outcome 1 (CO1): Understand the basics of machine learning and different types. (K2)

1. Differentiate supervised and unsupervised learning using examples.
2. Understand different terms and methods used in machine learning.

Course Outcome 2 (CO2): Differentiate regression and classification, apply Bayes' decision theory in classification (K3)

1. Differentiate regression and classification using examples
2. To apply Bayes' decision theory in classification for normal distributions

Course Outcome 3 (CO3): Apply linear algebra and statistical methods in discriminant based algorithms (K3)

1. Use statistical methods to obtain perceptron algorithm
2. Use support vector machines for separable classes and non separable classes

Course Outcome 4 (CO4): Understand the basics of unsupervised learning, ensemble methods and non-metric methods (K2)

1. Explain unsupervised learning with examples
2. Differentiate boosting and bagging.

3. Describe decision trees with examples.

Course Outcome 5 (CO5): Understand dimensionality reduction, evaluation and model selection techniques (K2)

1. Significance of dimensionality reduction.

2. Describe principal component analysis, Fischer's discriminant analysis.

3. Explain ROC curves, evaluation measures, validation set, bias-variance trade-off.

SYLLABUS

Module I

Basics of machine learning, supervised and unsupervised learning, examples, features, feature vector, training set, target vector, test set, feature extraction, over-fitting, curse of dimensionality. Review of probability theory, Gaussian distribution, decision theory.

Module II

Regression: linear regression, error functions in regression, multivariate regression, regression applications, bias and variance. Classification : Bayes' decision theory, discriminant functions and decision surfaces, Bayesian classification for normal distributions, classification applications.

Module III

Linear discriminant based algorithm: perceptron, gradient descent method, perceptron algorithm, support vector machines, separable classes, non-separable classes, multiclass case.

Module IV :

Unsupervised learning: Clustering, examples, criterion functions for clustering, proximity measures, algorithms for clustering. Ensemble methods: boosting, bagging. Basics of decision trees, random forest, examples.

Module V :

Dimensionality reduction: principal component analysis, Fischer's discriminant analysis. Evaluation and model Selection: ROC curves, evaluation measures, validation set, bias-variance trade-off. Confusion matrix, recall, precision, accuracy.

Text Books:

1. Bishop, C. M. "Pattern Recognition and Machine Learning" Springer, New York, 2006.
2. Theodoridis, S. and Koutroumbas, K. "Pattern Recognition". Academic Press, San Diego, 2003.

References:

1. Hastie, T., Tibshirani, R. and Friedman, J. "The Elements of Statistical Learning". Springer. 2001.
2. Duda, R.O., Hart, P.E., and Stork, D.G. "Pattern Classification". Wiley, New York, 2001.

Course Contents and Lecture Schedule

No	Topic	No. of Lectures
1	Module I	
1.1	Basics of machine learning, supervised and unsupervised learning, examples,	2
1.2	features, feature vector, training set, target vector, test set	2
1.3	feature extraction, over-fitting, curse of dimensionality.	1
1.4	Review of probability theory, Gaussian distribution, decision theory.	2
2	Module II	
2.1	Regression: linear regression, error functions in regression	2
2.2	multivariate regression, regression applications, bias and variance.	2
2.3	Classification : Bayes' decision theory,	1
2.4	discriminant functions and decision surfaces,	1
2.5	Bayesian classification for normal distributions, classification applications.	2
3	Module III	
3.1	Linear discriminant based algorithm: perceptron,	1
3.2	gradient descent method, perceptron algorithm,	2
3.3	support vector machines ,	1
3.4	SVM for separable classes and non-separable classes, multiclass case.	2
4	Module IV	
4.1	Unsupervised learning: Clustering, examples, criterion functions for	2

	clustering,	
4.2	proximity measures, algorithms for clustering.	2
4.3	Ensemble methods: boosting, bagging.	1
4.4	Basics of decision trees, random forest, examples.	2
5	Module V	
5.1	Dimensionality reduction: principal component analysis,	2
5.2	Fischer's discriminant analysis.	1
5.3	Evaluation and model selection: ROC curves, evaluation measures,	2
5.4	validation set, bias-variance trade-off.	1
5.5	confusion matrix, recall, precision, accuracy.	1

Simulation Assignments (using Python or Matlab)

- Working with Probability Distributions, Gaussian pdf generation
- Regression examples
- Classification examples
- Perceptron
- SVM
- Unsupervised learning techniques to find natural groupings and patterns in data
- Dimensionality reduction techniques

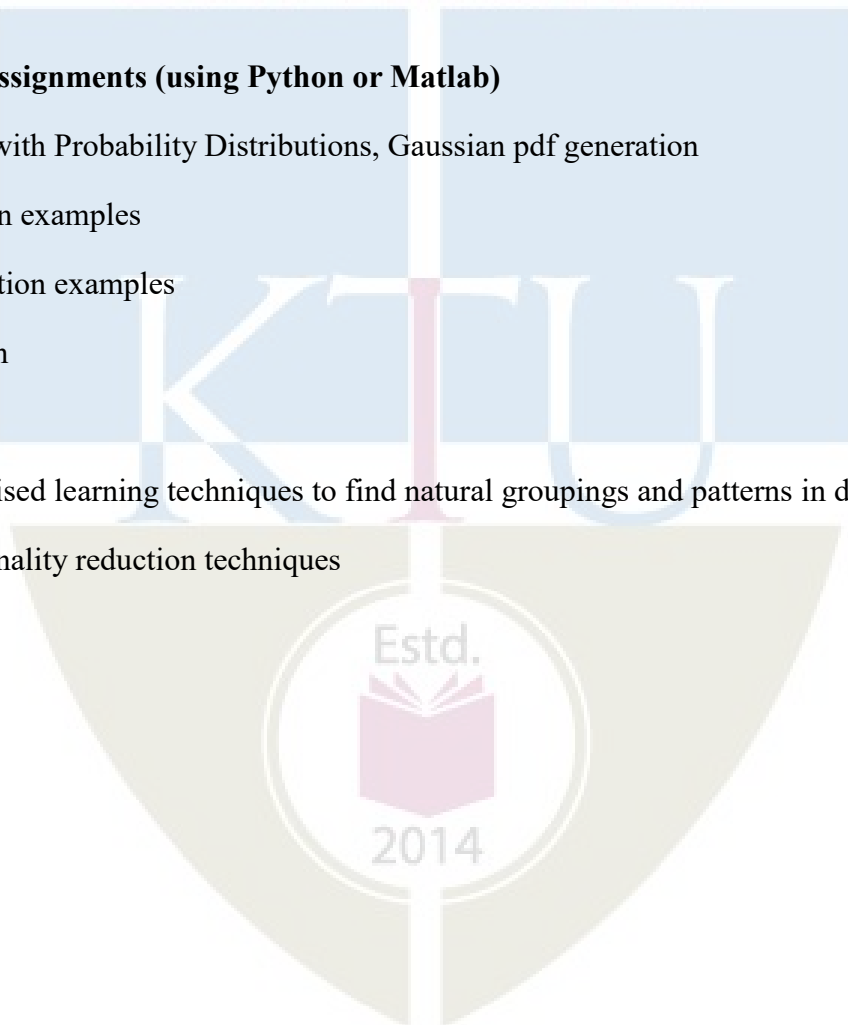

Model Question Paper**APJ ABDULKALAM TECHNOLOGICAL UNIVERSITY
MODEL QUESTION PAPER****ECT463 MACHINE LEARNING****Time: 3 hours****Max. Marks:100****PART A**Answer *all* questions. Each question carries *3 marks*.

1. Explain machine learning with examples.
2. Explain over-fitting in machine learning
3. Explain regression with examples
4. State Bayes decision theory
5. Draw a simple perceptron model
6. How SVM is used for multiclass problem?
7. Explain clustering with examples.
8. Explain decision trees with examples.
9. Explain ROC curves.
10. Explain bias-variance trade-off.

PART BAnswer *anyone* question from each module. Each question carries *14 marks*.**MODULE I**

11. (a) Explain the terms features, training set, target vector, and test set (8 marks)
- (b) Distinguish supervised and unsupervised machine learning with examples. (6 marks)

OR

12. (a) Explain a multi-variate Gaussian distribution along with its parameters (6 marks)
- (b) Explain curse of dimensionality in machine learning? (8 marks)

MODULE II

13. (a) Differentiate regression and classification with examples (8 marks)
- (b) Explain bias and variance for regression (6 marks)

OR

14. (a) Obtain the decision surface for an equi-probable two class system, where the probability density functions of 1-dimensional feature vectors in both classes are normally distributed. (8 marks)
- (b) Show that the Bayesian classifier is optimal with respect to minimizing the classification error probability. (6 marks)

MODULE III

13. (a) Give a step by step description of the perceptron algorithm in classification. (8 marks)
(b) Explain the significance of gradient descent method in machine learning algorithms. (6 marks)

OR

14. (a) Obtain the cost function for optimization in SVM for separable classes. (8 marks)
(b) How SVM is used in non-separable classes? (6 marks)

MODULE IV

13. (a) Explain different criterion functions for clustering (8 marks)
(b) Give a description of different clustering algorithms (6 marks)

OR

14. (a) Explain different ensemble methods in classification. (8 marks)
(b) Illustrate random forest algorithm. (6 marks)

MODULE V

13. (a) Explain the significance of dimensionality reduction in machine learning. (6 marks)
(b) Describe Fisher Discriminant Analysis. (8 marks)

OR

14. (a) How performance evaluation and model selection is done in machine learning (8 marks)
(b) Explain confusion matrix, recall, precision, and accuracy. (6 marks)



ECT473	DSP ARCHITECTURES	CATEGORY	L	T	P	CREDIT
		PEC	2	1	0	3

Preamble: The aim of the course is to give an overview of the commonly used DSP algorithms, their applications and various techniques for the algorithmic and architecture level optimisations through various algorithm to architecture mapping which can lead to efficient hardware implementations. The course also introduces the basic features in Digital Signal Processors, DSP Architecture with case studies, the latest architectural trends in DSPs and their programming tools.

Prerequisite: ECT 303 Digital Signal Processing

Course Outcomes: After the completion of the course the student will be able to

CO 1	Identify the basic resource constraints in a practical DSP system and solve them using various techniques/transformations that map the DSP algorithms to efficient architectures.
CO 2	Illustrate various single core and multicore Digital Signal Processor architectures and identify the optimal processor for solving real life signal processing problems.
CO 3	Develop algorithms to solve signal processing problems using the latest hardware platforms and software tools.

Mapping of course outcomes with program outcomes

	PO 1	PO 2	PO 3	PO 4	PO 5	PO 6	PO 7	PO 8	PO 9	PO 10	PO 11	PO 12
CO 1	3	3	3	3								2
CO 2	3	3	3	3								2
CO 3	3	3	3	3	3			1	2	2	1	2

Assessment Pattern

Bloom's Category		Continuous Assessment Tests		End Semester Examination
		1	2	
Remember	K1	10	10	10
Understand	K2	20	10	20
Apply	K3	10	20	50
Analyse		10	10	20
Evaluate				
Create				

Mark distribution

Total Marks	CIE	ESE	ESE Duration
150	50	100	3 hours

Continuous Internal Evaluation Pattern:

Attendance	: 10 marks
Continuous Assessment Test (2 numbers)	: 25 marks
Assignment/Quiz/Course project	: 15 marks

End Semester Examination Pattern: There will be two parts; Part A and Part B. Part A contain 10 questions with 2 questions from each module, having 3 marks for each question. Students should answer all questions. Part B contains 2 questions from each module of which student should answer any one. Each question can have maximum 2 sub-divisions and carry 14 marks.

Course Level Assessment Questions

Course Outcome 1 (CO1): Identify the basic resource constraints in a practical DSP system and solve them using various techniques/transformations that map the DSP algorithms to efficient architectures.

1. Compare and contrast various DSP Algorithm representations
2. Demonstrate the algorithmic representation of typical DSP algorithms (Convolution, Various Filters, Transforms and filterbanks etc.) using Block Diagram, Signal Flow Graph, Data Flow Graph and Dependence Graph.
3. Explain the popular filter structures for efficient hardware implementations.
4. Define Loop bound, Iteration bound, critical path and explain their significance in the design of hardware systems.
5. Apply various algorithms to compute the iteration bound of a given Data Flow Graph (DFG).
6. Design efficient architectures for implementing DSP algorithms using pipelining, parallel processing, folding and unfolding techniques that meets various requirements such as low computational complexity, power and area.

Course Outcome 2 (CO2): Illustrate various single core and multicore Digital Signal Processor architectures and identify the optimal processor for solving real life signal processing problems.

1. Explain the basic architectural features of Digital Signal Processors
2. Explain the role of ILP in designing Digital Signal Processor architectures.
3. Compare and contrast Harvard and VLIW architectures of DSPs.

4. Explain the architecture of various single and multicore DSPs.
5. Give a brief description of the peripherals available for implementing DSP tasks in various single and multicore DSPs.

Course Outcome 3 (CO3): Develop algorithms to solve signal processing problems using the latest hardware platforms and software tools.

1. Explain various steps involved in implementing a signal processing task using CSS.
2. Explain the role of Open CL in the development of portable codes that take advantage of the parallel computing power of modern electronic hardware,
3. Explain the role of Open MP Application Programming Interface (API) and Inter-Processor Communication (IPC) in implementing DSP applications in realtime.

SYLLABUS

Module 1: Basics of DSP Algorithm Representation to Architecture Mapping

DSP Algorithm representations –Block Diagram, Signal Flow Graph, Data Flow Graph, Dependence Graph;

Introduction to Filter structures- Recursive, Non-recursive and Lattice structures;

Fundamentals of DSP algorithm to architecture mapping - Loop bound, Iteration Bound, Critical Path, Algorithms for computing Iteration Bound – Longest Path Matrix Algorithm, Minimum Cycle Mean Algorithm.

Module 2: Transformations for Improved DSP Architectures

VLSI performance measures - area, power, and speed; Transformations for improved DSP architectures: Pipelining - Pipelining of FIR filters, Concept of Fine Grain Pipelining; Parallel Processing – Designing Parallel FIR systems, Pipelining and Parallel Processing for low power. Folding and Unfolding Transformations and its applications.

Module 3: Single Core DSP Architectures

Introduction to General Purpose Processors (GPP), Microcontroller Units (MCU), Digital Signal Processors (DSP) – comparison and Applications. The key features of a Digital Signal Processors – Dedicated hardware units, circular buffers, Modified bus structures and Memory access schemes. Introduction to Harvard, Super Harvard DSP architectures, Concept of Instruction Level Parallelism, VLIW Architecture and Single Instruction Multiple Data (SIMD) processor architecture.

Case Study: Introduction to a popular DSP from Texas Instruments, The TMS320C67xxSeries Processor - CPU Architecture - CPU Data Paths and Control - Timers - Internal Data/ Program Memory - External Memory Interface.

Module 4: Homogeneous Multicore DSPs

Introduction to multicore processors and their applications, A brief comparison between DSP SoCs, Field-Programmable Gate Arrays (FPGAs), Graphic Processors and CPUs.

Introduction to Multicore DSP Architectures: The TMS320C66x architecture: The CPU, Overview of the peripherals, Useful instructions, Overview of the memory organization.

Module 5: Programming the DSPs

Introduction to Code Composer Studio (CCS) software development tool and the TMS320C6678 EVM kit. Introduction to OpenMP Application Programming Interface (API) and Open Computing Language (OpenCL). Implementation of simple DSP algorithms – Dot Product.

Latest architectural trends in digital signal processing: Introduction to Heterogeneous Multicore DSP Architecture and FPGA SoCs.

Text Books

1. Keshab K. Parhi, "VLSI Signal Processing Systems, Design and Implementation", John Wiley & Sons, 1999
2. Naim Dahnoun, "Multicore DSP: from algorithms to real-time implementation on the TMS320C66x SoC". John Wiley & Sons, 2018.
3. Steven W. Smith, "The Scientist and Engineer's Guide to Digital Signal Processing" Second Edition, California Technical Publishing, 1999.
4. Reference Link for Overview of Latest Processor Architectures –
[Digital signal processors \(DSPs\) | Overview | Processors | TI.com,](https://training.ti.com/system/files/docs/c66x-corepac-instruction-set-reference-guide.pdf)
<https://training.ti.com/system/files/docs/c66x-corepac-instruction-set-reference-guide.pdf>

Reference Books

1. Rulph Chassaing, "Digital Signal Processing and Applications with the C6713 and C6416 DSK", John Wiley & Sons, 2005.
2. Sen M. Kuo, Woon-Seng S. Gan, Digital Signal Processors: Architectures, Implementations, and Applications, Prentice Hall, 2004.
3. Lars Wanhammar, DSP Integrated Circuits, Academic Press, 1999.
4. B Venkataramani, M Bhaskar, "Digital Signal Processors: Architecture, Programming and Applications", 2nd Ed., Tata McGraw-Hill Education, 2002.
5. A. Kharin, S. Vityazev and V. Vityazev, "Teaching multi-core DSP implementation on EVM C6678 board," 2017 25th European Signal Processing Conference (EUSIPCO), 2017, pp. 2359-2363, doi: 10.23919/EUSIPCO.2017.8081632

Course Contents and Lecture Schedule

No	Topic	No. of Lectures
1	Basics of DSP Algorithm Representation to Architecture Mapping	
1.1	DSP Algorithm representations –Block Diagram, Signal Flow Graph, Data Flow Graph, Dependence Graph.	2
1.2	Introduction to Filter structures- Recursive, Non-recursive and Lattice structures.	1
1.3	Fundamentals of DSP algorithm to architecture mapping - Loop bound, Iteration Bound, Critical Path,	2
1.4	Algorithms for computing Iteration Bound – Longest Path Matrix	2

	Algorithm, Minimum Cycle Mean Algorithm.	
2	Transformations for Improved DSP Architectures	
2.1	VLSI performance measures - area, power, and speed	1
2.2	Pipelining - Pipelining of FIR filters, Concept of Fine Grain Pipelining.	2
2.3	Parallel Processing – Designing Parallel FIR systems.	2
2.4	Pipelining and Parallel Processing for low power.	1
2.5	Folding and Unfolding Transformations and its applications.	3
3	Single Core DSP Architectures	
3.1	Introduction to General Purpose Processors (GPP), Microcontroller Units (MCU), Digital Signal Processors (DSP) - comparison and Applications.	1
3.2	The key features of a Digital Signal Processors – Dedicated hardware units, Circular Buffers, Modified bus structures and Memory access schemes.	1
3.3	Introduction to Harvard, Super Harvard DSP architectures, Concept of Instruction Level Parallelism, VLIW Architecture and Single Instruction Multiple Data (SIMD) processor architecture.	1
3.4	Case Study: Introduction to a popular DSP from Texas Instruments, The TMS320C67xx Series Processor- CPU Architecture - CPU Data Paths and Control - Timers – Multichannel Buffered Serial Ports (McBSPs)- Internal Data/ Program Memory - External Memory Interface.	4
4	Homogeneous Multicore DSPs	
4.1	Introduction to multicore processors and their applications, A brief comparison between DSP SoCs, Field-Programmable Gate Arrays (FPGAs), Graphic Processors and CPUs	1
4.2	Introduction to Multicore DSP Architectures: The TMS320C66x architecture: The CPU, Overview of the peripherals, Useful instructions, Overview of the memory organization.	5
5	Programming the DSPs	
5.1	Introduction to Code Composer Studio (CCS) software development tool and the TMS320C6678 EVM kit.	2
5.2	Introduction to Open MP Application Programming Interface (API) and Open Computing Language (OpenCL).	2
5.3	Implementation of simple DSP algorithms - Dot Product	1
5.4	Latest architectural trends in digital signal processing: Introduction to Heterogeneous Multicore DSP Architecture and FPGA SoCs.	1

Simulation Assignments/Course Projects:

1. Design an n-tap FIR filter. Apply pipelining to reduce the effective critical path. Simulate both using CCS and study the effect of pipelining.
2. Design an n-tap FIR filter. Construct a parallel FIR system. Simulate both using CCS and study the effect of parallel processing.
3. Consider a 6-tap FIR filter with data-broadcast structure. Apply folding using a folding factor of 2 on the structure. Implement both the filters and verify the functionality. Analyse the effect of folding.
4. Design a 4-bit bit-serial adder. Apply unfolding by 2 to make it a digit-serial adder. Implement both the filters and verify the functionality. Analyse and study the effect of unfolding.
5. Implement and realise the n-tap FIR filter utilising the multicore architecture of the TMS320C6678 processor. Implement and check the functionality by applying real time signals such as voice or recorded. Study the performance parameters.
6. Implement FFT algorithm using a single core on a TMS320C6678 processor. Extend it for the implementation of a 2-D FFT algorithm on an 8x8 data utilising the multicore architecture of the same processor. Study the performance parameters.
7. Study and implementation of a Real-Time Synthetic Aperture Radar (SAR) Algorithm Using TMS320C6678.
8. Design and implementation of a very large FFT algorithm using TMS320C6678 SoC.



Model Question paper**APJ ABDUL KALAM TECHNOLOGICAL UNIVERSITY**

SEVENTH SEMESTER B.TECH DEGREE EXAMINATION, (Model Question Paper)

Course Code: ECT473**Course Name: DSP ARCHITECTURES**

Max. Marks: 100 Duration: 3 Hours

PART A

Answer all Questions. Each Carries 3 mark.

1	Differentiate between Signal Flow Graph (SFG) and Data Flow Graph (DFG) with example.	K2
2	Define the terms Loop Bound and Iteration Bound. Explain the role of Iteration Bound in determining the speed of execution of a hardware.	K2
3	What is pipelining? Explain with an example, how it helps in reducing the critical path delay in implementing the DSP systems.	K2
4	What is Fine-Grain pipelining? Explain	K2
5	In what way the Super Harvard architecture based DSPs differs from the normal microprocessors?	K2
6	Explain with a suitable example, the role of circular buffers in implementing DSP algorithm.	K3
7	Compare and contrast DSP SoCs and FPGAs.	K2
8	Explain the CCS tools available for data visualisation.	K2
9	What is the concept of Heterogeneous Multicore DSP Architecture? Quote an example processor?	K1
10	Quoting a suitable example, explain the architectural advantages of an FPGA SoC.	K2
	PART – B Answer one question from each module; each question carries 14 marks.	
	Module - I	

registers? Explain.

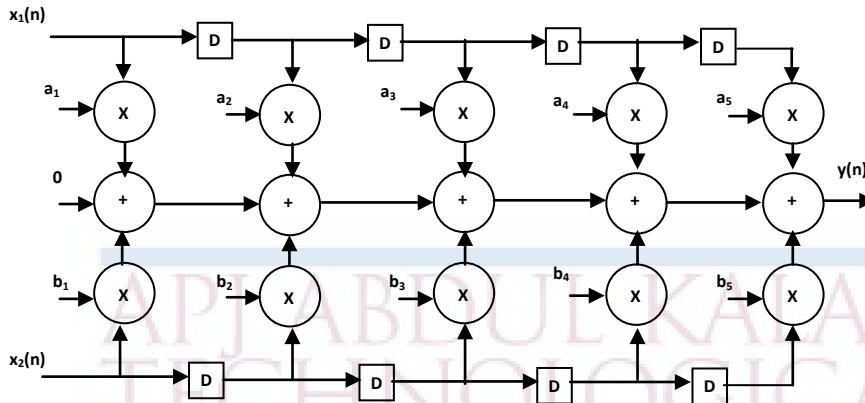

OR

- 14 Consider a direct-form implementation of the FIR filter
 $y(n) = ax(n) + bx(n-2) + cx(n-3)$
 Assume that the time required for 1 multiply-add operation is T
- Pipeline this filter such that the clock period is approximately T
 - Draw block filter architecture for a block size of three. Pipeline this block filter such that clock period is about T. What is the system sample

14
 CO1
 K3

Module - III

- 15 The TMS320C6713 processor is used for an application where, it has to read the audio data inputted through the codec and has to send the data which is band limited to 1 KHz, to another external device for further processing. If the processor is connected to the audio codec through the McBSPs of the TMS320C6713 processor.
- Draw the interconnection diagram showing all the necessary signals, for inputting an analog signal to the processor for the processing and to send the result there after, with the entire data transfer initiated through the McBSPs.
 - What are the various registers need to be programmed in order to effect the data transfer. Explain the role and functionality of each.

CO2
 K3
 6
 8

OR

- 16 a. Explain the role of a timer in a Digital Signal Processor with suitable examples. With reference to the Timer Control Register (Register fields given), explain the various facilities provided by the Timers in the TMS3206713 DSP processor.
- | | | | | | | | |
|------|----|-------|--------|--------|--------|--------|------|
| 31 | 12 | 11 | 10 | 9 | 8 | | |
| Rsvd | | TSTAT | INVINP | CLKSRC | C/P | | |
| 7 | 6 | 5 | 4 | 3 | 2 | 1 | 0 |
| HLD | GO | Rsvd | PWID | DATIN | DATOUT | INVOUT | FUNC |
- b. The 6713 processor is used to control a device which is to be triggered every 5msec.

10
 CO2
 K3
 5

	If the Timer 0 peripheral of the processor is used for the purpose, what are the values to be loaded into the Timer 0 Period and Timer 0 Count registers to perform the required operation?	
	Module - IV	
17	Draw a neat block schematic of the architecture of TMS320C66x series of processor. Briefly explain the role of each block.	14 CO2 K3
	OR	
18	Give an overview of the memory organisation in TMS320C66xx series of processors. Explain the role of various memory controllers and interfaces in relieving the CPU load..	14 CO3 K2
	Module - V	
19	Explain the role of OpenMP Application Programming Interface and Open Computing Language (OpenCL) in implementing DSP applications that requires multithreading. Explain with reference to a case study project that you have implemented.	14 CO3 K2
	OR	
20	Give an overview of the latest architectural trends for implementing DSP algorithms. How will you compare FPGA SoCs and DSP SoCs?	14 CO3 K3



APJ ABDUL KALAM
TECHNOLOGICAL
UNIVERSITY

SEMESTER VII

OPEN ELECTIVE



ECT415	MECHATRONICS	CATEGORY	L	T	P	CREDIT
		OEC	2	1	0	3

Preamble: This course introduces students to the rapidly emerging, multi-disciplinary, and exciting field of Mechatronics.

Prerequisite: Nil

Course Outcome: After the successful completion of the course the student will be able to :

CO1	Understand the working principles of various sensors and actuators in Mechatronics systems and be able to choose the suitable one for the real world application
CO2	Formulate and simulate models of mechatronics systems
CO3	Explain the implementation of PLC in mechatronics applications
CO4	Explain the standard fabrication techniques and principle of operation of MEMS devices
CO5	Design and Analysis of commonly encountered mechatronics systems for real time application

Mapping of course outcomes with program outcomes

	PO1	PO2	PO3	PO4	PO5	PO6	PO7	PO8	PO9	PO10	PO11	PO12
CO1	3	3										
CO2	3	3										
CO3	3	3	2									
CO4	3	3										
CO5	3	3										

Assessment Pattern

Bloom's Category	Continuous Assessment Tests		End Semester Examination
	1	2	
Remember	10	10	20
Understand	30	30	60
Apply	10	10	20
Analyse			
Evaluate			
Create			

Mark distribution

Total Marks	CIE	ESE	ESE Duration
150	50	100	3 hours

Continuous Internal Evaluation Pattern:

Attendance	: 10 marks
Continuous Assessment Test (2 numbers)	: 25 marks
Assignment/Quiz/Course project	: 15 marks

End Semester Examination Pattern: There will be two parts; Part A and Part B. Part A contain 10 questions with 2 questions from each module, having 3 marks for each question. Students should answer all questions. Part B contains 2 questions from each module of which student should answer any one. Each question can have maximum 2 sub-divisions and carry 14 marks.

Course Level Assessment Questions

Course Outcome 1 (CO1): Understand the working principles of various sensors and actuators in Mechatronics systems and be able to choose the suitable one for the real world application

1. Illustrate the working of a strain gauged load cell
2. Explain the working of any one non-contact temperature measurement system
3. Explain the principle of operation and suggest two applications of Hall effect sensor in mechatronic systems.
4. With neat sketches explain the working of a double acting hydraulic actuator.
5. Design a hydraulic circuit to operate a winch fitted with a hydraulic motor. The motor should be run clockwise, counter clockwise and stopped. Use a manually operated valve.
6. Explain any two situations when pneumatic actuators are preferred over hydraulic ones.

Course Outcome 2 (CO2): Formulate models of mechatronics systems

1. Derive the mathematical model of a general electrical system and draw its analogy with a mechanical system.
2. Explain the working of a mechanical device using closed loop control system with the help of a suitable example.

Course Outcome 3 (CO3): Explain the implementation of PLC in mechatronics applications

1. Explain 'latching' in PLC logic with an example.
2. Illustrate the significance of Internal Relays in PLC program
3. Consider a pneumatic system with single-solenoid controlled valves and involving two cylinders A and B, with limit switches a₋, a₊, b₋, b₊ detecting the limits of the piston rod movements. Design a ladder programme with the requirement being when the start switch is triggered, the sequence A₊, B₊, A₋,

10s time delay, B- occurs and stop at that point until the start switch is triggered again.

Course Outcome 4(CO4): Explain the standard fabrication techniques and principle of operation of MEMS devices

1. Explain the steps involved in photolithography. State the chemicals used in each of the stages along with the operating conditions.
2. Explain the criteria for choice of surface or bulk micromachining techniques in the design of micro systems.
3. Explain with block diagram the steps in LIGA process. State two advantages of LIGA process over other micro machining techniques.

Course Outcome 5 (CO5): Design and Analysis of commonly encountered mechatronics systems for real time applications

1. With the help of a neat sketch explain the different mechatronics modules used in automatic car park barrier system
2. Explain with a neat sketch the mechatronic implementation of a household weighing machine
3. With a neat sketch, explain the physical system and working of a pick and place robot.

SYLLABUS

MODULE I

Introduction to Mechatronics: Structure of Mechatronics system. Comparison between traditional and mechatronics approach. Sensors - Characteristics -Temperature, flow, pressure sensors. Displacement, position and proximity sensing by magnetic, optical, ultrasonic, inductive, capacitive and eddy current methods. Encoders: incremental and absolute. Resolvers and synchros. Piezoelectric sensors. Acoustic Emission sensors. vibration sensors. Force and tactile sensors. Range finders: ultrasonic and light based range finders

MODULE II

Actuators: Hydraulic and Pneumatic actuators - Directional control valves, pressure control valves, process control valves. Rotary actuators. Development of simple hydraulic and pneumatic circuits using standard Symbols. Electrical drives: DC, AC, brushless, servo and stepper motors. Harmonic drive. Magnetostrictive actuators and piezoelectric actuators.

MODULE III

System modeling - Mathematical models and basic building blocks of general mechanical, electrical, fluid and thermal systems. Typical elements of open and closed loop control systems. Adaptive controllers for machine tools.

Programmable Logic Controllers (PLC) –Basic structure, input/ output processing. Programming: Timers, Internal Relays, Counters and Shift registers. Development of simple ladder programs for specific purposes.

MODULE IV

Micro Electro Mechanical Systems (MEMS): Fabrication: Deposition, Lithography, Micromachining methods for MEMS -Surface and Bulk, Deep Reactive Ion Etching (DRIE) and LIGA processes. Principle, fabrication and working of MEMS based pressure sensor, accelerometer and gyroscope.

MODULE V

Mechatronics in Robotics- choice of Sensors and Actuators. Robotic vision system - Image acquisition: Vidicon, charge coupled device (CCD) and charge injection device (CID) cameras. Image processing techniques: histogram processing: sliding, stretching, equalization and thresholding.

Case studies of Mechatronics systems: Automatic camera, bar code reader, simple weighing machine, pick and place robot, automatic car park barrier system, automobile engine management system.

Text Books:

1. Bolton W., Mechatronics: Electronic Control Systems in Mechanical and Electrical Engineering, Person Education Limited, New Delhi, 2007
2. Ramachandran K. P., G. K. Vijayaraghavan, M. S. Balasundaram, Mechatronics: Integrated Mechanical Electronic Systems, Wiley India Pvt. Ltd., New Delhi, 2008.
3. Saeed B. Niku, Introduction to Robotics: Analysis, Systems, Applications, Person Education Inc., New Delhi, 2006.
4. Devdas Shetty, Richard A. Kolk, “Mechatronics System Design”, Thomson Learning Publishing Company, Vikas publishing house, Second edition, 2001.

Reference Books:

1. David G. Aldatore, Michael B. Histan, Introduction to Mechatronics and Measurement Systems, McGraw-Hill Inc., USA, 2003.
2. Gordon M. Mair, Industrial Robotics, Prentice Hall International, UK, 1998.
3. HMT, Mechatronics, Tata McGraw-Hill Publishing Company Ltd., New Delhi, 2004.
4. Vijay K. Varadan, K. J. Vinoy, S. Gopalakrishnan, Smart Material Systems and MEMS: Design and Development Methodologies, John Wiley & Sons Ltd., England, 2006.
5. Bishop, Robert H. The Mechatronics Handbook-2 Volume Set. CRC press, 2002.

Course Plan Course Contents and Lecture Schedule

Module No	Topic	No. of Lectures
1	Introduction to Mechatronics: Structure of Mechatronics system. Comparison between traditional and mechatronics approach	2
	Sensors - Characteristics -Temperature, flow, pressure sensors.	1
	Displacement, position and proximity sensing by magnetic, optical, ultrasonic, inductive, capacitive and eddy current methods	1
	Encoders: incremental and absolute. Resolvers and synchros.	1
	Piezoelectric sensors. Acoustic Emission sensors. vibration sensors, Force and tactile sensors	2
	Range finders: ultrasonic and light based range finders	1
2	Actuators: Hydraulic and Pneumatic actuators - Directional control valves	1
	pressure control valves, process control valves,	1
	Rotary actuators.	1
	Development of simple hydraulic and pneumatic circuits using standard Symbols.	1
	Electrical drives: DC, AC, and brushless, servo stepper motors	2
	Harmonic drive.	1
3	System modeling - Mathematical models and basic building blocks of general mechanical, electrical, fluid and thermal systems.	2
	Typical elements of open and closed loop control systems.	1
	Adaptive controllers for machine tools.	1
	Programmable Logic Controllers (PLC) –Basic structure, input/output processing.	1
	Programming: Timers, Internal Relays, Counters and Shift registers.	2
	Development of simple ladder programs for specific purposes	1
4	Micro Electro Mechanical Systems (MEMS): Fabrication: Deposition, Lithography	1
	Micromachining methods for MEMS -Surface and Bulk,	1
	Deep Reactive Ion Etching (DRIE) and LIGA processes.	1
	Principle, fabrication and working of MEMS based pressure sensor, accelerometer and gyroscope	2
	Mechatronics in Robotics- choice of Sensors and Actuators.	1
	Robotic vision system - Image acquisition: Vidicon, charge coupled device (CCD) and charge injection device (CID) cameras.	1
	Image processing techniques: histogram processing: sliding, stretching, equalization and thresholding.	2

5	Case studies of Mechatronics systems: Automatic camera, bar code reader, simple weighing machine, picks and place robot,	2
	automatic car park barrier system, automobile engine management system.	1
Total		35

Model Question Paper

**A P J ABDUL KALAM TECHNOLOGICAL UNIVERSITY
SEVENTH SEMESTER B TECH DEGREE EXAMINATION
COURSE: ECT415 MECHATRONICS
TIME: 3 HRS MAX. MARKS: 100**

PART A

Answer All Questions

- | | | |
|----|--|---|
| 1 | Differentiate between absolute and incremental encoders | 3 |
| 2 | List six examples of temperature sensors | 3 |
| 3 | Explain how cushioning is achieved in pneumatic actuators with a sketch. | 3 |
| 4 | Mention any two differences between finite position and infinite position valves | 3 |
| 5 | List any 2 controlling factors in wet etching. | 3 |
| 6 | Sketch and label a MEMS based pressure sensor | 3 |
| 7 | What is latching? Draw a simple latched circuit | 3 |
| 8 | Write down the describing equations of basic mechanical building blocks | 3 |
| 9 | Illustrate the histogram processing technique for enhancing the image contrast | 3 |
| 10 | Bring out any 3 difference between CCD and CID camera. | 3 |

PART B

Answer one question from each module. Each question carries 14 marks.

Module I

11(A)	Explain the working of an optical absolute encoder. How the number of tracks and sectors of absolute encoder is related to the resolution of the encoder?	6	
11(B)	Explain the structure of a mechatronics system. How is it different from the traditional approach?	8	
OR			
12(A)	Explain the sensor characteristics to be considered when choosing a sensor for a mechatronics application	8	
12(B)	Compare the working of resolver and synchro	6	
Module II			
13(A)	Develop a pneumatic circuit with standard symbols, to operate two cylinders in sequence. Explain its working.	8	

13(B)	Explain the constructional features and working of brushless DC motor	6	
OR			
14(A)	Illustrate the working of Harmonic Drives with neat sketches	8	
14(B)	Design a hydraulic circuit to operate a winch fitted with a hydraulic motor. The motor should be run clockwise, counter clockwise and stopped. Use a manually operated valve.	6	
Module III			
15(A)	Draw and explain the block diagram of a feedback control system.	4	
15(B)	Develop a PLC ladder program for the following sequence: Start a motor with push switch, and then after a delay of 90s, start a pump. When the motor is switched off, the pump will get switched off after a delay of 5s. Mention the logic used for each rung in the program to substantiate your answer.	10	
OR			
16(A)	Explain how a PLC can be used to handle analog inputs?	4	
16(B)	Explain the model a fluid flow system with basic building blocks, clearly mention all assumptions	10	
Module IV			
17(A)	Explain the steps involved in photolithography. State the chemicals used in each of the stages along with the operating conditions	6	
17(B)	Compare and contrast various micro manufacturing techniques	8	
OR			
18(A)	Describe the various mechanical problems associated with surface micromachining	6	
18(B)	Explain the LIGA process associated with MEMS fabrication	8	
Module V			
19(A)	With the help of a neat sketch explain the different mechatronics modules used in automatic car park barrier system	10	
19(B)	List any four applications of robotic vision systems	4	
OR			
20(A)	Explain the working of Barcode reader with reference to the coding schemes. Mention the steps to process the digits in a barcode for a particular product. Develop the steps in a program for reading the barcode.	10	
20(B)	List the steps in thresholding technique in image processing	4	

ECT425	BIOMEDICAL INSTRUMENTATION	CATEGORY	L	T	P	CREDIT
		OEC	2	1	0	3

Preamble: This course aims to give a brief introduction to human physiology and various instrumentations system used for measurement and analysis of physiological parameters.

Prerequisite: Nil

Course Outcomes: After the completion of the course the student will be able to

CO 1	Explain the human anatomy and physiological signal Measurements.
CO 2	Illustrate various techniques used for measurement of Blood flow, blood pressure, and respiration rate and body temperature.
CO 3	Analyze the recording of ECG, EEG, EMG and ERG signals.
CO 4	Summarize the concept of assisting and therapeutic devices.
CO 5	Describe the advances in medical imaging techniques.

Mapping of course outcomes with program outcomes

	PO1	PO2	PO3	PO4	PO5	PO6	PO7	PO8	PO9	PO10	PO11	PO12
CO 1	3	3										
CO 2	3	3										
CO 3	3	3										
CO 4	3	3										
CO 5	3	3										

Assessment Pattern

Bloom's Category	Continuous Assessment Tests		End Semester Examination
	1	2	
Remember	10	10	20
Understand	30	30	60
Apply	10	10	20
Analyse			
Evaluate			
Create			

Mark distribution

Total Marks	CIE	ESE	ESE Duration
150	50	100	3 hours

Continuous Internal Evaluation Pattern:

Attendance	:	10marks
Continuous Assessment Test(2 numbers)	:	25 marks
Assignment	:	15marks

End Semester Examination Pattern: There will be two parts; Part A and Part B. Part A contain 10 questions with 2 questions from each module, having 3 marks for each question. Students should answer all questions. Part B contains 2 questions from each module of which student should answer any one. Each question can have maximum 2 sub-divisions and carry 14 marks.

Course Level Assessment Questions**Course Outcome 1 (CO1):Introduction to human physiological system**

1. Describe in detail the formation of resting potential and action potential in human body.
2. Briefly explain the physiological functions of human circulatory system
3. Briefly explain the physiological functions of human respiratory system

Course Outcome 2 (CO2):Bio potential electrodes and ECG

1. Describe different bio-potential electrode used to measure bioelectric events.
2. Explain in details the electro conduction system of a human heart. Illustrate the same with PQRST waveform of the ECG.

Course Outcome 3 (CO3):Measurement of blood pressure, blood flow and heart sound

1. With help of neat diagram explain how the oscilloetric method helps to measure blood pressure.
2. Write a short note on phonocardiography.

Course Outcome 4 (CO4):Measurement of EEG, EMG and Respiratory Parameters and therapeutic aid

1. Write a short note on tidal volume and vital capacity in breathing mechanism with neat diagram.
2. Explain heart lung machine with the help of neat diagram.
3. Explain spirometer for measurement of respiratory parameters
4. Explain standard 10-20 electrode placement system for EEG measurement.

Course Outcome 5 (CO5):Advances in Radiological Imaging andElectrical safety

1. Draw the block diagram and explain the principle of ultrasound imaging.
2. What are the biological effects of NMR imaging over CT?
3. What is the basic principle of CT? How image reconstruction is done in CT

Syllabus

Module 1

Introduction to human physiological system

Physiological systems of the body (brief discussion on Heart and cardio vascular system, Anatomy of nervous system, Physiology of respiratory systems) problems encountered in biomedical measurements. Sources of bioelectric potentials – resting and action potentials -propagation of action potentials – bio electric potentials example (ECG, EEG, EMG, ERG, EOG, EGG etc.)

Module 2

Bio potential electrodes and ECG

Bio potential electrodes – theory – microelectrodes – skin surface electrodes – needle electrodes – biochemical transducers – transducers for biomedical applications. Electro conduction system of the heart. Electro cardiograph – electrodes and leads – Einthoven triangle, ECG read out devices, ECG machine – block diagram.

Module 3

Measurement of blood pressure, blood flow and heart sound

Measurement of blood pressure – direct and indirect measurement – oscillometric measurement – ultrasonic method, measurement of blood flow and cardiac output, plethysmography – photo electric and impedance plethysmographs. Measurement of heart sounds – phonocardiography

Module 4

Measurement of EEG, EMG and Respiratory Parameters

Electro encephalogram – neuronal communication – EEG measurement, recording and analysis. Muscle response – Electromyogram (EMG) – Nerve Conduction velocity measurements – Electromyogram Measurements. Respiratory parameters – Spiro meter, pneumograph

Therapeutic Aid

Cardiac pacemakers – internal and external pacemakers, defibrillators. Ventilators, heart lung machine, hemodialysis, lithotripsy, infant incubators

Module 5

Advances in Radiological Imaging

X-rays- principles of generation, uses of X-rays- diagnostic still picture, fluoroscopy, angiography, endoscopy, and diathermy. Basic principle of computed tomography, magnetic resonance imaging system and nuclear medicine system – radiation therapy. Ultrasonic imaging system - introduction and basic principle.

Electrical safety

Electrical safety – physiological effects of electric current – shock hazards from electrical equipment – method of accident prevention, introduction to tele-medicine

Text Book

1. J. G. Webster, Medical Instrumentation, Application and Design, John Wiley and Sons

2. L. Cromwell, F. J. Weibell and L. A. Pfeiffer, Biomedical Instrumentation Measurements, Pearson education, Delhi, 1990.
3. R. S. Khandpur, Handbook of Biomedical Instrumentation, Tata Mc Graw Hill
4. J. J. Carr and J. M. Brown, Introduction to Biomedical Equipment Technology, Pearson Education

References:

1. John Enderele , Susan Blanchard, Joseph Bronzino, Introduction to Biomedical Engg, Academic Press
2. Welkowitz, Biomedical Instruments, Theory and Design, Elsevier
3. Jerry L Prince, Jonathan M Links, Medical Imaging Signals & Systems, Pearson Education

Course Contents and Lecture Schedule

No	Topic	No. of Lectures
1	Introduction to human physiological system	
1.1	Physiological systems of the body (brief discussion on Heart and cardiovascular system, Anatomy of nervous system, Physiology of respiratory systems) problems encountered in biomedical measurements.	3
1.2	Sources of bioelectric potentials – resting and action potentials	1
1.3	Propagation of action potentials – bio electric potentials example (ECG, EEG, EMG, ERG, EOG, EGG etc.)	2
2	Bio potential electrodes and ECG	
2.1	Bio potential electrodes – basic theory – microelectrodes – skin surface electrodes – needle electrodes	2
2.2	Biochemical transducers – transducers for biomedical applications	1
2.3	Instrumentation for clinical laboratory: Bio Potential amplifiers – instrumentation amplifiers, isolation amplifiers, chopper amplifier	2
2.4	Electro conduction system of the heart, Electro cardiograph – electrodes and leads – Einthoven triangle,	2
2.5	ECG read out devices, ECG machine – block diagram.	1
3	Measurement of blood pressure, blood flow and heart sound	
3.1	Measurement of blood pressure – direct and indirect measurement – oscillometric measurement – ultrasonic method	2
3.2	Measurement of blood flow and cardiac output, plethysmography – photo electric and impedance plethysmographs	2
3.3	Measurement of heart sounds – phonocardiography	1
4	Measurement of EEG, EMG and Respiratory Parameters, Therapeutic Aid	
4.1	Electro encephalogram – neuronal communication – EEG measurement,	2

	recording and analysis	
4.2	Muscle response– Electromyogram (EMG) – NerveConduction velocity measurements- Electromyogram Measurements.	2
4.3	Respiratory parameters – Spiro meter,pneumograph	1
4.4	Cardiac pacemakers – internal and external pacemakers,defibrillators.	1
4.5	Ventilators, heart lung machine, hemodialysis, lithotripsy, infantincubators	3
5	Advances in Radiological Imaging and Electrical Safety	
5.1	X-rays- principles of generation, uses of X-rays- diagnostic stillpicture, fluoroscopy, angiography, endoscopy, diathermy	2
5.2	Basic principle of computed tomography, magnetic resonanceimaging system and nuclear medicine system	3
5.3	Ultrasonic imaging system - introduction and basic principle	1
5.4	Electrical safety– physiological effects of electric current –shock hazards from electrical equipment –method of accident prevention, introduction to tele- medicine	2

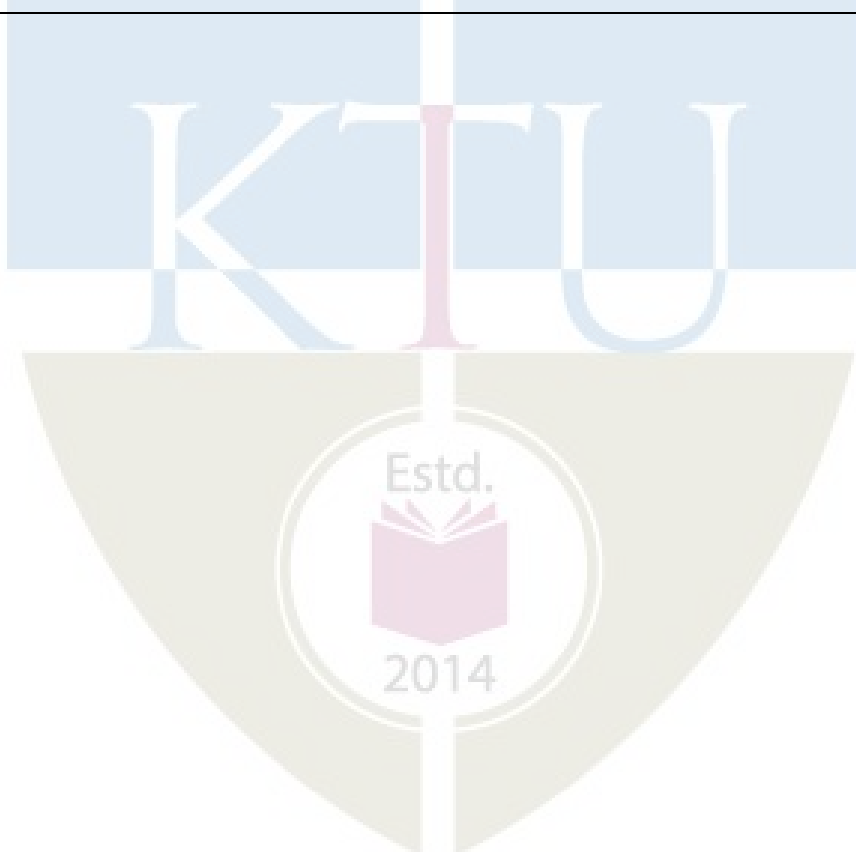

Model Question Paper

A P J ABDUL KALAM TECHNOLOGICAL UNIVERSITY
SEVENTH SEMESTER B TECH DEGREE EXAMINATION

Course: ECT425 BIOMEDICAL INSTRUMENTATION

Time:3Hrs.

Max. Marks:100

PART A

Answer All Questions

- 1 Enumerate different rhythms in EEG with frequency ranges. (3) K_1
- 2 Write short notes on the formation of bio potential signal (3) K_2
- 3 What is the difference between microelectrodes and needle electrodes? (3) K_2
- 4 With the help of a neat diagram of the Einthoven triangle, mention the necessity of the Einthoven triangle. (3) K_2
- 5 With the help of neat diagram explain ultrasonic method of blood pressure measurement. (3) K_2
- 6 Explain photoplethysmography. (3) K_2
- 7 Explain DC defibrillator with the help of neat diagram (3) K_2
- 8 What is infant incubator? How it works? (3) K_2
- 9 Mention any three applications of telemetry medicine. (3) K_1
- 10 Explain different methods of electric accident prevention. (3) K_2

PART B

Answer one question from each module. Each question carries 14 mark.

Module I

- 11(A) Describe in detail the formation of resting potential and action potential in human body (7) K_2
- 11(B) Briefly explain the physiological functions of human circulatory system (7) K_2

OR

- 12(A) Explain the problems encountered in the biomedical measurements (6) K_2
- 12(B) Briefly explain the physiological functions of human respiratory system. (8) K_2

Module II

- 13(A) Describe different bio-potential electrode used to measure bioelectric events. (6) K_2
- 13(B) Explain chopper amplifier with a neat diagram? (8) K_2

OR

- 14 Explain in details the electro conduction system of a human heart. Illustrate the same with PQRS waveform of the ECG (14) K_2

Module III

- 15(A) With help of neat diagram explain how the oscillometric method helps to measure Blood Pressure. (9) K_2
- 15(B) Write a short note on phonocardiography. (5) K_2

OR

- 16(A) What is blood pressure? How it is measured? (7) K_2
- 16(B) Explain with the help of neat diagram, impedance plethysmograph for measurement of blood flow (7) K_2

Module IV

- 17(A) Write a short note on tidal volume and vital capacity in breathing mechanism with neat diagram. (7) K_2
- 17(B) Explain heart lung machine with the help of neat diagram. (7) K_2

OR

- 18(A) Explain spirometer for measurement of respiratory parameters (7) K_2
- 18(B) Explain standard 10-20 electrode placement system for EEG measurement. (7) K_2

Module V

- 19(A) Draw the block diagram and explain the principle of ultrasound imaging. (8) K_2
- 19(B) What are the biological effects of NMR imaging over CT? (6) K_2

OR

- 20(A) What is the basic principle of CT? How image reconstruction is done in CT (8) K_2
- 20(B) How X-rays are produced? What are its properties? (6) K_2

ECT435	ELECTRONIC HARDWARE FOR ENGINEERS	CATEGORY	L	T	P	CREDIT
		OEC	2	1	0	3

Preamble: This course will introduce students the exciting field of electronic hardware designing and prototyping. This will help students to innovate faster with electronics technology.

Prerequisite: Nil

Course Outcome: After the successful completion of the course the student will be able to

CO1	Identify various electronic components along with their specifications.
CO2	Design PCB using modern software tools.
CO3	Explain various testing procedures of electronic products.
CO4	Experiment and debug various software and hardware issues of a PC.

Mapping of course outcomes with program outcomes

	PO1	PO2	PO3	PO4	PO5	PO6	PO7	PO8	PO9	PO10	PO11	PO12
CO1	3	1	1									
CO2	3	2	2		3							
CO3	3	2	2				1					
CO4	3	3	2		1							

Assessment Pattern

Bloom's Category	Continuous Assessment Tests		End Semester Examination
	1	2	
Remember	10	10	20
Understand	30	30	60
Apply	10	10	20
Analyse			
Evaluate			
Create			

Mark distribution

Total Marks	CIE	ESE	ESE Duration
150	50	100	3 hours

Continuous Internal Evaluation Pattern:

Attendance	: 10 marks
Continuous Assessment Test (2 numbers)	: 25 marks
Assignment/Quiz/Course project	: 15 marks

End Semester Examination Pattern: There will be two parts; Part A and Part B. Part A contain 10 questions with 2 questions from each module, having 3 marks for each question. Students should answer all questions. Part B contains 2 questions from each module of which student should answer any one. Each question can have maximum 2 sub-divisions and carry 14 marks.

Course Level Assessment Questions

Course Outcome 1 (CO1): Identify various electronic components along with their specifications.

1. Describe the colour coding of a 4 band resistor and find the colour code for a 470k resistor.
2. Compute the value of capacitors coded as 104 and 47K.

Course Outcome 2 (CO2): Design PCB using modern software tools.

1. Explain PCB design flow chart.
2. Design PCB layout of a regulated full wave rectifier circuit.

Course Outcome 3(CO3): Explain various testing procedures of electronic products.

1. Explain Acceptance testing and Type testing of a product.
2. Explain the testing procedure of a UPS.

Course Outcome 4 (CO4): Experiment and debug various software and hardware issues of a PC.

1. Why is it important to backup files securely? Explain the different types of backup techniques used.

SYLLABUS**MODULE I****Types of Components**

Active Components: Diode, Transistor, MOSFET, LED, SCR, Integrated Circuits(ICs)

Passive Components: Resistor, Capacitor, Inductor, Transformer, Speaker/Buzzer.

Component Package Types

Axial lead, Radial Lead, Single Inline Package(SIP), Dual Inline Package (DIP), Transistor Outline (TO), Pin Grid Array (PGA), Metal Electrode Face (MELF), Leadless Chip Carrier (LCC), Small Outline Integrated Circuit (SOIC), Quad Flat Pack(QFP) and Thin QFP(TQFP), Ball Grid Array (BGA), Plastic Leaded Chip Carrier (PLCC).

Introduction & Brief History

What is PCB, Difference between PWB and PCB, Types of PCBs: Single Sided (Single Layer), Multi-Layer (Double Layer), PCB Materials.

MODULE II**Introduction to Electronic Design Automation (EDA)**

Brief History of EDA, Latest Trends in Market, How it helps and why it requires, Different EDA tools, Introduction to SPICE and PSpice Environment, Introduction and Working of PROTEUS

Introduction to PCB Design using OrCAD tool

PCB Designing Flow Chart: Schematic Entry, Net listing, PCB Layout Designing, Prototype Designing, Design Rule Check(DRC), Design For Manufacturing(DFM)

PCB Making: Printing, Etching, Drilling, Assembly of components

Introduction to PCB Design using PROTEUS tool

Assembly of simple circuits

MODULE III**Types of Product Testing**

Acceptance Testing, Type Testing, Safety Testing, Safety, safety standards, safety certificates (CE, UL and VDE), Effect of environmental testing(refer to IEC 60068-1 for guidance)

Quality Standards

General awareness of quality standards, quality management systems & documentation, Awareness on ISO 17025, ISO 9001, Calibration and Uncertainty of measurements, Awareness on disposal of Electronic waste

Testing Procedures: Switch Mode Power Supply - (Applicable Standard: IS 14886) Safety Testing (Earth Leakage current Test, Dielectric Test, Short Circuit Protection), Performance Testing (Line Regulation, Load Regulation for a variation of Load Min to Max load and vice versa)

Inverter, UPS - Inverter (Applicable Standard: IS 13314) Visual Inspection, High Voltage Test, Insulation Resistance Test, No Load Test, Output Test. UPS (Applicable Standard: IEC 62040-3) Steady State Input Voltage Tolerance, Output-Normal Mode – No Load, Full Load, Overload, Short Circuit

Safety Testing of Household Appliances: (Applicable Standard IS 302-1) Definitions and Terminology, Protection against Shock, Power Input and Current, Leakage Current and Electric Strength at Operating Temperature

Testing of Electric Iron/Electric Kettle: (Applicable Standard: IS 302-2) Ground bond resistance, Touch Current, Temperature (Thermostatic Cut off) Power Consumption.

MODULE V

Assembly and Maintenance of PC: Introduction to Computer - Difference between Hardware & Software, Booting concept, Different input and output devices/ cables, connectors, different types of motherboard, controller cards, Ethernet cards, Different types of RAM used in PC's.

Installation: BIOS setting, Formatting of Hard Disk, Installation of Windows, Off-line drive installation / online drive installation / Windows file repairing / BIOS password break / Administrative password break / Data recovery. Application Software Installation, Dual Booting Installation.

Assembly and dismantling: Assembly and dismantling of PCs front panel connection, servicing of computer, Type of Backup, Taking Backup files and fine tuning the system, running diagnostics tool, running of virus protection program.

Text Books:

1. C. Robertson. PCB Designer's Reference. Prentice Hall, 2003.
2. D. Brooks, Signal Integrity Issues and Printed Circuit Board Design, Prentice Hall, 2003.
3. Advances in Electronic Testing, edited by D Gizopoulos, 2006

Reference Books:

1. C. Coombs, Printed Circuits Handbook, McGraw-Hill Professional, 6 edition, 2007.
2. Electronic Testing Handbook, McGraw-Hill, Dec 1993
3. PC Repair and Maintenance, A Practical Guide, Joel Rosenthal, Kevin Irwin, 2003
4. A Simple Guide to Computer Maintenance and Troubleshooting, AdaneNegaTarekegn, Alemu KumilachewTegegne, 2015

Course Plan Course Contents and Lecture Schedule

Module No	Topic	No. of Lectures
1	Active Components, Passive Components	3
	Packages: Axial lead, Radial Lead, SIP, DIP, TO,PGA, MELF, LCC, SOIC, QPF and TQFP, BGA, PLCC.	2
	PCB, Difference between PWB and PCB, Types of PCBs	1
2	Brief History of EDA, Latest Trends in Market, How? Why? Different EDA tools	1
	Introduction to SPICE and PSPICE Environment	1
	Introduction and Working of PROTEUS	2
	PCB Designing Flow Chart: Schematic Entry, Net listing, PCB Layout Designing, Prototype Designing, Design Rule Check(DRC), Design For Manufacturing(DFM)	2
	PCB Making: Printing, Etching, Drilling, Assembly of components	1
	Introduction to PCB Design using PROTEUS tool: Assembly of simple circuits	2
3	Acceptance Testing, Type Testing , Safety Testing, Safety, safety standards, safety certificates (CE, UL and VDE), Effect of environmental testing(refer to IEC 60068-1 for guidance)	3
	General awareness of quality standards, quality management systems & documentation, Awareness on ISO 17025, ISO 9001, Calibration and Uncertainty of measurements, Awareness on disposal of Electronic waste	1
4	SMPS Testing: (Applicable Standard: IS 14886) Safety Testing(Earth Leakage current Test, Dielectric Test, Short Circuit Protection), Performance Testing (Line Regulation, Load Regulation for a variation of Load Min to Max load and vice versa)	2
	Inverter (Applicable Standard: IS 13314) Visual Inspection, High Voltage Test, Insulation Resistance Test, No Load Test, Output Test. UPS (Applicable Standard: IEC 62040-3) Steady State Input Voltage Tolerance, Output-Normal Mode – No Load, Full Load, Overload, Short Circuit	2
	(Applicable Standard IS 302-1) Definitions and Terminology, Protection against Shock, Power Input and Current, Leakage Current and Electric Strength at Operating Temperature	1
	(Applicable Standard: IS 302-2) Ground bond resistance, Touch Current, Temperature (Thermostatic Cut off) Power Consumption.	1
	Difference between Hardware & Software, Booting concept	1
	Different input and output devices/ cables, connectors	1

5	Different types of motherboard, controller cards, Ethernet cards, Different types of RAM used in PC's.	1
	BIOS setting, Formatting of Hard Disk	1
	Installation of Windows, Off-line drive installation / online drive installation / Windows file repairing / BIOS password break / Administrative password break / Data recovery	2
	Application Software Installation, Dual Booting Installation.	1
	Assembly and dismantling of PCs front panel connection, servicing of computer	1
	Type of Backup, Taking Backup files and fine tuning the system, running diagnostics tool	1
	Running of virus protection program.	1

Model Question Paper

**APJ ABDUL KALAM TECHNOLOGICAL UNIVERSITY
SEVENTH SEMESTER B TECH DEGREE EXAMINATION
COURSE: ECT435 ELECTRONIC HARDWARE FOR ENGINEERS
TIME: 3 HRS MAX. MARKS: 100**

PART A

Answer All Questions

- | | | |
|----|--|---|
| 1 | Differentiate between active and passive components. | 3 |
| 2 | List any six type of electronic component packages. | 3 |
| 3 | State Moore's law and how it is related to electronic design automation. | 3 |
| 4 | What is a Gerber file? How it is used while making a PCB? | 3 |
| 5 | What does CE certification in electronic product mean? | 3 |
| 6 | What does ISO IEC stand for? | 3 |
| 7 | What do you mean by line regulation in a power supply? | 3 |
| 8 | How is leakage current of a device related to temperature? | 3 |
| 9 | Write the operations taking place during the booting of a system | 3 |
| 10 | Does Windows have a data recovery tool? If so, Explain. | 3 |

PART B

Answer one question from each module. Each question carries 14 marks.

Module I

- | | | |
|-------|---|---|
| 11(A) | Compare Dual Inline Package and Ball Grid Array IC Package. | 8 |
| 11(B) | Compute the value of capacitors coded as 103 and 4K7. | 6 |

OR

- | | | |
|-------|---|---|
| 12(A) | Describe the colour coding of a 4 band resistor and find the colour code for a 2.2k resistor. | 7 |
| 12(B) | Make a note on different types of PCBs. | 7 |

Module II

- 13(A) Explain the process of manufacturing PCB from a PCB layout. 6
- 13(B) Explain the relevance of Design Rule Check and Design For Manufacturing in PCB development. 8

OR

- 14(A) Explain PCB design flow chart. 8
- 14(B) Make a note on the tool PROTEUS and explain how it is different from OrCAD. 6

Module III

- 15(A) Explain Acceptance testing and Type testing of a product. 8
- 15(B) Explain different ways for disposal of Electronic waste. 6

OR

- 16(A) What are uncertainties in measurements? How can you quantify it? 8
- 16(B) What is IEC 60068-1 ? What properties of the specimen is it concerned about? 6

Module IV

- 17(A) Explain the testing procedure of an SMPS. 10
- 17(B) Explain the relevance of Insulation resistance test. 4

OR

- 18(A) Explain the testing procedure of an Inverter. 10
- 18(B) What does IS 302 standard part 1 refer to? 4

Module V

- 19(A) Explain the different types of computer RAM with their pros and cons. 7
- 19(B) What is the difference between an online drive installation and an offline drive installation in case of windows? Explain the installation process. 7

OR

- 20(A) What are the various steps involved in Assembly and dismantling of PCs front panel connection? 8
- 20(B) How can a user install two operating systems in a single computer? Explain. 6

ECT445	IOT AND APPLICATIONS	CATEGORY	L	T	P	CREDIT
		OEC	2	1	0	3

Preamble: This course aims to develop skills in IoT system development and to apply the same in real life applications.

Prerequisite: ECT342 Embedded systems and ECT401 Wireless communication (optional)

Course Outcomes: After the completion of the course, a student will be able to

CO 1 K1	Understand the IoT fundamentals and architecture modeling (K1)
CO 2 K2	Understand the smart things in IoT and functional blocks (K2)
CO3 K2	To understand the communication networks and protocols used in IoT. (K2)
CO 4 K3	To understand the cloud resources, data analysis and applications. (K3)
CO5 K3	To apply the IoT processes in embedded applications. (K3)

Mapping of course outcomes with program outcomes

	PO 1	PO 2	PO 3	PO 4	PO 5	PO 6	PO 7	PO 8	PO 9	PO 10	PO 11	PO 12
CO 1	3	3	2		1			2				2
CO 2	3	3	3		3			2				2
CO 3	3	3	3		3			2	3			2

Assessment Pattern

Bloom's Category		Continuous Assessment Tests		End Semester Examination
		1	2	
Remember	K1	20	10	20
Understand	K2	30	20	40
Apply	K3	0	20	40
Analyse				
Evaluate				
Create				

Mark distribution

Total Marks	CIE	ESE	ESE Duration
150	50	100	3 hours

Internal Evaluation Pattern:

Attendance : 10 marks
 Continuous Assessment Test (2 numbers) : 25 marks
 Assignment/Quiz/Course project : 15 marks

End Semester Examination Pattern: There will be two parts; Part A and Part B. Part A contain 10 questions with 2 questions from each module, having 3 marks for each question. Students should answer all questions. Part B contains 2 questions from each module of which student should answer any one. Each question can have maximum 2 sub-divisions and carry 14 marks.

Course Level Assessment Questions

Course Outcome 1 (CO1): Understand the IoT fundamentals and architecture modeling (K1)

1. What is the definition of IoT and different characteristics of IoT
2. Define the architectural view of IoT and functional blocks
3. What are the different levels of IoT

Course Outcome 2 (CO2): Understand the smart things in IoT and functional blocks (K2)

1. What are the different smart things in IoT
2. How the communication is established among nodes and nodes and cloud.
3. What are the protocols that are used in IoT

Course Outcome 3 (CO3): To understand the communication networks and protocols used in IoT. (K2)

1. Differentiate between IEEE standard protocols
2. Explain the advantages of next generation IP based protocols used in IoT
3. Define different layers used in embedded protocols

Course Outcome 4 (CO4): To understand the cloud resources, data analysis and applications. (K3)

1. Explain how data is stored in IoT environment and processed
2. How to use cloud resources and different options available
3. How end devices can be used to control input and output devices

Course Outcome 5 (CO5): To apply the IoT processes in embedded applications. (K3)

1. What are the security and privacy concerns of IoT
2. Explain the typical applications of IoT.
3. Describe the processes involved in implementing a smart city.

SYLLABUS

Module 1 (7 Hours)

Introduction to IoT technology: Definitions and Characteristics of IoT, IoT Architectural View, Physical Design of IOT, Logical Design of IoT- IoT Functional blocks, IoT communication models, IoT Enabling Technologies, IoT Levels & Deployment Templates.

Module 2 (7 Hours)

IoT and M2M- M2M, Difference between IoT and M2M, SDN and NFV for IoT, Smart Objects: The “Things” in IoT: Sensors, Actuators, and Smart Objects, Sensor Networks- Wireless Sensor Networks (WSNs), Communication Protocols for Wireless Sensor Networks- Connecting Smart Objects- Communication Criteria.

Module 3 (7 Hours)

Unified Data Standards –Protocols –IEEE 802.15.4 -The Physical Layer, The Media-Access Control Layer, Uses of 802.15.4 ,The Future of 802.15.4: 802.15.4e and 802.15.4g–Modbus–ZigBee-Zigbee Architecture- LoRaWAN -Standardization and Alliances, Physical Layer, MAC Layer, Topology, LTE-M, NB-IoT-Network layer –The next generation: IP-based protocols - 6LoWPAN and RPL, Overview of the 6LoWPAN Adaptation Layer .

Module 4 (9 hours)

Data Collection, storage and computing Using a Cloud Platform-Introduction, Cloud Computing Paradigm for Data Collection, Storage and Computing-Cloud Computing Paradigm, Cloud Deployment Models-Everything as a Service and Cloud Service Models-SaaS, PaaS, IaaS, DaaS. Cloud based platforms-XIVELY, NIMBITS.

IoT Physical Devices & Endpoints-IoT Device-Building blocks –Raspberry-Pi -Board-Linux on Raspberry-Pi-Raspberry-Pi Interfaces (serial, SPI, I2C). Raspberry Pi interfacing and programming examples using python (LED, switch, sensor, serial, SPI, I2C devices). Controlling GPIO outputs and displaying sensor readings using web interface/cloud (Python programming is required only for assignments and projects and not for examinations. Other end nodes and platforms can also be used).

Module 5 (6 Hours)

IoT privacy, security and vulnerabilities solutions, vulnerabilities, security requirements, threat analysis, security tomography, layered attacker model, Identity management, access control, secure message communication.

Smart and Connected Cities-An IoT Strategy for Smarter Cities-Vertical IoT Needs for Smarter Cities, Global vs. Siloed Strategies-Smart City IoT Architecture-Street Layer, City Layer, Data Center Layer, Services Layer- Smart City Security Architecture - Smart City Use-Case Examples – Street lighting, smart parking, smart traffic and air pollution monitoring

Maximum 35 /36 Hours

Text Books

1. Vijay Madiseti and ArshdeepBahga, “Internet of Things (A Hands-on- Approach)”, 1st Edition, VPT, 2014 (Module1,2,4)
2. David Hanes, Gonzalo Salgueiro, Patrick Grossetete, Rob Barton and Jerome Henry, —IoT Fundamentals: Networking Technologies, Protocols and Use Cases for Internet of Things, Cisco Press, 2017. (Module2,3,5)
3. Rajkamal, “Internet of Things : Architecture and Design Principles”, McGraw Hill (India) Private Limited.
4. Raspberry Pi Cookbook, Software and Hardware Problems and solutions, SimonMonk, O'Reilly (SPD), 2016, ISBN.

Reference Books/Papers

1. Olivier Hersent, David Boswarthick, Omar Elloumi , “The Internet of Things –Key applications and Protocols”, Wiley, 2012 (Module 3)
2. Al-Fuqaha et al. Internet of things: A survey on enabling technologies, protocols, and applications. IEEE Communications Surveys & Tutorials (2015), pp. 2347- 2376.
3. The Internet of Things (The MIT Press Essential Knowledge series) Paperback – March 20, 2015 by SamuelGreengard
4. The Internet of Things: Converging Technologies for Smart Environments and Integrated Ecosystems, OviduVermesan and Peter Friess, RiverPublishers.
5. Internet of Things - From Research and Innovation to Market Deployment-RIVER PUBLISHERS, PETER FRIESS, OVIDIU VERMESAN (Editors)
6. Internet of Things Security and Data Protection, Sébastien Ziegler, Springer

International Publishing 2019.

Course Contents and Lecture Schedule

No	Topic	No. of Lectures
1	Introduction to Internet of Things- 7Hrs	
1.1	Introduction, definition and characteristics	1
1.2	IoT architectural view, functional blocks	2
1.3	IoT Communication models, enabling technologies	2
1.4	IoT deployment levels	2
2	Essential components of IoT- 7Hrs	
2.1	IoT and M2M	2
2.2	Smart objects	2
2.3	Wireless sensor networks	3
3	IoT protocols- 7Hrs	
3.1	IEEE 802.15.4 protocols	2
3.2	Zigbee	1
3.3	6LoWPAN and RPL	2
3.4	LoraWAN, LTE-M and NB-IoT	2
4	Cloud storage and Programming the end device- 9Hrs	
4.1	Data storage and computation	3
4.2	Physical devices and end points	2
4.3	Raspberry pi programming	4
5	Security and Applications-6 Hrs	
5.1	Security and Privacy	2
5.2	Smart city application	2
5.3	Use case examples	2

Simulation Assignments:

1. At least one assignment should be programming examples (python or any other language) using Raspberry pi (Other options like arduino, node mcu etc. can also be used) Include I/O interfacing, SPI, I2C, serial, sensor interfacing and web interface.
2. Another assignment shall be an IoT system implementation of mini project consisting of a sensor, processing device, communication device and cloud storage (This can be individual or group projects). Mini project is essential for understanding the concepts of IoT.
3. Mini project can be done in the following areas.
 - a) Smart city (b) Weather monitoring system (c) air pollution monitoring (d) Smart parking (e) smart traffic (f) any other application/s where sensors/actuators devices are used.
4. Programming and mini project are essential for understanding the concepts of IoT.

Model Question Paper

APJ ABDUL KALAM TECHNOLOGICAL UNIVERSITY

SEVENTH SEMESTER B.TECH DEGREE EXAMINATION, (Model Question Paper)

Course Code: ECT445

Course Name: IOT AND APPLICATIONS

Max. Marks: 100

Duration: 3 Hours

PART A

(Answer for all questions. Each Question Carries 3 marks)

1. List any five characteristics of IoT
2. What are the IoT enabling technologies?
3. What is a wireless sensor network?
4. What are the limitations of smart objects in WSNs??
5. Explain the need for IP optimization in IoTs?
6. What are the transmission modes used in modbus?
7. What are the 4 different cloud deployment models? Explain
8. What is cloud computing? Explain.
9. List the five functional units of security
10. What is message integrity? How it is checked? [10 X 3 = 30 Marks]

PART – B

(Answer one question from each module; each question carries 14 Marks)

Module – I

11. (a) Write a note on physical design of IoT. [06 Marks]
 (b) Give a detailed description of the link layer, network layer, transport layer and application layer protocols. [08 Marks]

OR

12. (a) What are the functional blocks of IoT? Explain? [07 Marks]
 (b) Discuss different communication models used in IoT. [07 Marks]

Module – II

13. (a) What are the differences between IoT and M2M? [07 Marks]
 (b) What are the issues of conventional networking architectures? How is it solved in SDN? [07 Marks]

OR

14. (a) What are smart objects? What are their characteristics and the trends in smart objects? [07 Marks]
 (b) What are the characteristics and attributes to be considered for connecting smart objects? [07 Marks]

Module – III

15. (a) Explain IEEE 802.15.4 physical layer, MAC layer and security implementation with the help of frame formats. [09 Marks]
 (b) What are the modifications included in IEEE 802.15.4 e and g versions as compared to IEEE 802.15.4? [05 Marks]

OR

16. (a) With the help of a diagram explain the Zigbee protocol architecture. [07 Marks]
 (b) Explain LoraWAN architecture. Give a detailed description of the physical layer and MAC layer of LoraWAN [07 Marks]

Module – IV

17. (a) Write a note on different cloud service models [06 Marks]
 (b) What is virtualization in cloud computing? Explain the features, advantages and concerns of cloud computing. [08 Marks]

OR

18. (a) With the help of a diagram explain the basic building blocks of an IoT device [07 Marks]
- (b) Explain cloud based data collection, storage and computing services provided by XIVELY cloud platform. [07 Marks]

Module – V

19. (a) What is security and Privacy? List the 10 vulnerabilities of IoT. [07 Marks]
- (b) Explain the layered attacker model. [07 Marks]

OR

20. (a) With the help of a diagram explain the 4 layer smart city architecture. [07 Marks]
- (b) Write a note on street lighting architecture with the help of a diagram [07 Marks]

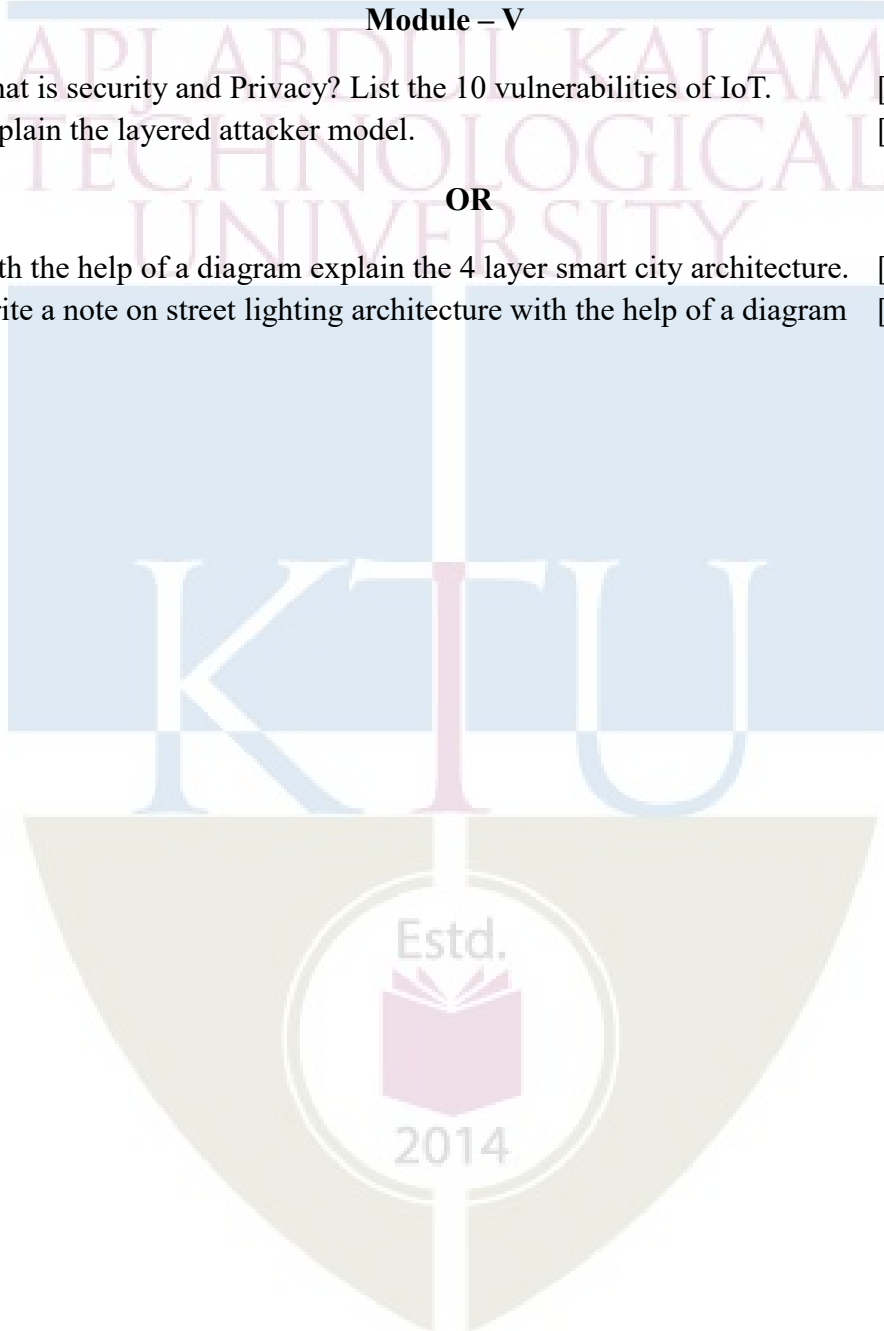

ECT455	ENTERTAINMENT ELECTRONICS	CATEGORY	L	T	P	CREDIT
		OEC	2	1	0	3

Prerequisite: Nil

Course objectives: The course aims to provide broad knowledge on various industry standards, algorithms and technologies used to carry out digital audio and video broadcasting in infotainment industry.

Course Outcomes: After the completion of the course the student will be able to

CO1 K2	Understand packetized streaming of digital media happens in the field of infotainment industry.
CO2 K2	Realise the critical aspects of DVB and DAB standards used for media broadcasting in infotainment industry.
CO3 K3	Apply video coding/compression algorithms are used to produce high-definition video in MPEG-4 standard.
CO4 K2	Understand modern display technologies for video reproduction.

Mapping of course outcomes with program outcomes

	PO 1	PO 2	PO 3	PO 4	PO 5	PO 6	PO 7	PO 8	PO 9	PO 10	PO 11	PO 12
CO 1	3	3										2
CO 2	3	3			2						2	2
CO 3	3	3			3						2	2
CO 4	3	3										2

Assessment Pattern

Bloom's Category		Continuous Assessment Tests		End Semester Examination
		1	2	
Remember	K1	10	10	20
Understand	K2	40	30	60
Apply	K3		10	20
Analyse				
Evaluate				
Create				

Mark distribution

Total Marks	CIE	ESE	ESE Duration
150	50	100	3 hours

Continuous Internal Evaluation Pattern:

Attendance	: 10 marks
Continuous Assessment Test (2 numbers)	: 25 marks
Assignment/Quiz/Course project	: 15 marks

End Semester Examination Pattern: There will be two parts; Part A and Part B. Part A contain 10 questions with 2 questions from each module, having 3 marks for each question. Students should answer all questions. Part B contains 2 questions from each module of which student should answer any one. Each question can have maximum 2 sub-divisions and carry 14 marks. Mark patterns are as per the syllabus with 100 % for theory.

Course Level Assessment Questions

Course Outcome 1 (CO1): Explain packetized streaming of digital media happens in the field of infotainment industry.

1. Discuss MPEG-2 standards for streaming multimedia data and aspects of synchronization, accessing scrambled programs and program synchronization.

Course Outcome 2 (CO2): Discuss the critical aspects of DVB and DAB standards used for media broadcasting in infotainment industry.

1. Describe the existing standards and features for modulation and demodulation schemes related with DAB, various types of DVB and DRM.

Course Outcome 3 (CO3): Explain how the video coding/compression algorithms are used to produce high-definition video in MPEG-4 standard.

1. Understanding quantization, DCT, differential PCM for MPEG-4 video compression.
2. Developing audio sub-band coding methods based on psychoacoustic model of human ear.

Course Outcome 4 (CO4): Discuss modern display technologies for video reproduction.

1. Explain the basic principles of video reproduction and display technology such as CRT, LCD, plasma and OLED

ELECTRONICS & COMMUNICATION ENGINEERING
SYLLABUS

Module	Course contents	Hours
I	<p>Brief Review of Analog Television: Scanning, Horizontal and Vertical Synchronization, Color information, Transmission methods. NTSC and PAL standards.</p> <p>Digital media streaming: Packetized elementary stream of audio-video data, MPEG data stream, MPEG-2 transport stream packet, Accessing a program, scrambled programs, program synchronization. PSI, Additional (Network information and service description) information in data streams for set-top boxes.</p>	7
II	<p>Digital Video Broadcasting (DVB): Satellite TV broadcasting – DVB-S Parameters, DVB-S Modulator, DVB-S set-top box, DVB-S2.</p> <p>Cable TV broadcasting – DVB-C Standard, DVB-C Modulator, DVB-C set-top box.</p> <p>Terrestrial TV broadcasting – DVB-T Standard, DVB-T Modulator, DVB-T Carriers and System Parameters, DVB-T receiver.</p> <p>Broadcasting for Handheld devices – DVB-H Standard</p> <p>DVB tele-text, DVB subtitling system.</p>	7
III	<p>Digital Audio Broadcasting (DAB): Comparison of DAB with DVB. Physical layer of DAB. DAB Modulator, DAB Data Structure, DAB single frequency networks, Data broadcasting using DAB.</p> <p>Digital Radio Mondiale (DRM): Transmitter and receiver, Data rates.</p>	6
IV	<p>High Definition Video and Audio: Pixel resolution, Comparison with Standard Definition TV, Review of Discrete Cosine Transforms (DCT), Video Compression - Quantization levels, Horizontal/Vertical blanking interval, Vertical Color resolution, DPCM of moving pictures, DCT, Run-length coding. MPEG-4 Video coding.</p> <p>Psycho-acoustic model, Principle of audio coding, Sub-band coding in MPEG layer 1 and 2, MPEG Layer 3 and Dolby Digital, Multichannel sound.</p>	8
V	<p>Display Technology: Block diagram of video reproduction system in a TV, Cathode Ray tubes, Basic principle of Plasma displays, LC displays, Light-emitting diode displays, Field emission displays, Organic light emitting device displays.</p>	7

	Television of future: Holographic TV, Virtual Reality, Augmented Reality.	
--	--	--

Textbooks

1. W. Fischer, Digital Video and Audio Broadcasting Technology: A Practical Engineering Guide (Signals and Communication Technology), Springer, 2020
2. Lars-Ingemar Lundström, Understanding Digital Television An Introduction to DVB Systems with Satellite, Cable, Broadband and Terrestrial TV, Focal Press, Elsevier, 2006.
3. K F Ibrahim, Newnes Guide to Televeision and Video Technology, Newnes, 2007.
4. Jiun-Haw Lee, David N. Liu, Shin-Tson Wu, Introduction to Flat Panel Displays, Wiley, 2008.

References

1. C. Poynton, "Digital Video and HD Algorithms and Interfaces,"Morgan Kaufmann, 2012.
2. Wolfgang Hoeg, Thomas Lauterbach, Digital audio broadcasting: principles and applications of DAB, DAB+ and DMB, Wiley, 2009.
3. John Watkinson, Introduction to Digital Audio, Focal Press, 1994.
4. John Watkinson, Art of Digital Video, Focal Press, 2008.
5. John Watkinson, Introduction to Digital Video, Focal Press, 2001.

Course content and Lecture plan

No	TOPIC	No of Lectures
MODULE 1		
1.1	Analog Television, Scanning, Horizontal and Vertical Synchronization, Colour information, NTSC and PAL standards.	2
1.2	Analog TV Transmission	1
1.3	Packetized elementary stream. MPEG data stream, MPEG-2 transport stream packet	2
1.4	Accessing a program, scrambled programs, program synchronization. Program Specific Information	1
1.5	Additional (Network information and service description) information in data streams	1
MODULE II		
2.1	Introduction to DVB, DVB-S Parameters, DVB-S Modulator, DVB-S set-top box, DVB-S2.	2
2.2	DVB-C Standard, DVB-C Modulator, DVB-C set-top box.	1
2.3	DVB-T Standard, DVB-T Modulator, DVB-T Carriers and System Parameters, DVB-T receiver.	2

2.4	Broadcasting for Handheld devices – DVB-H Standard	1
2.5	DVB teletext, DVB subtitling system.	1
MODULE III		
3.1	Introduction to DAB, Comparison of DAB with DVB.	1
3.2	Physical layer of DAB. DAB Modulator, DAB Data Structure, DAB single frequency networks, Data broadcasting using DAB.	3
3.3	Digital Radio Mondiale (DRM): Transmitter and receiver, Data rates.	2
MODULE IV		
4.1	HDTV versus SDTV, Pixel resolution,	1
4.2	Review of Discrete Cosine Transforms (DCT)	1
4.3	Video Compression - Quantization levels, Horizontal/Vertical blanking interval, Vertical Colour resolution, DPCM of moving pictures, DCT, Run-length and Huffman coding. MPEG-4.	3
4.4	Psychoacoustic model, Principle of audio coding	1
4.5	Subband coding in MPEG layer 1 and 2	1
4.6	MPEG Layer 3 and Dolby Digital, Multichannel sound	1
MODULE V		
5.1	Block diagram of video reproduction system in a TV	1
5.2	Cathode Ray tubes	1
5.3	Basic principle of Plasma displays, LC displays, Light-emitting diode displays, Field emission displays, Organic light emitting device displays.	3
5.4	Holographic TV, Virtual Reality, Augmented Reality.	2

Simulation Assignments (optional)

- 1 Realise live streaming of audio and video data using Python/MATLAB-Simulink or other platforms.
- 2 Realise a basic video compression scheme from basic principles studied from this course using Python/MATLAB. Obtain the performance parameters before and after comparison.
- 3 Simulate a DAB transmitter and receiver system using MATLAB/Simulink and study its Performance under Gaussian noise.

Model Question paper**APJ ABDUL KALAM TECHNOLOGICAL UNIVERSITY**VII SEMESTER B. TECH DEGREE EXAMINATION, (**Model Question Paper**)**Course Code: ECT455****Course Name: ENTERTAINMENT ELECTRONICS**

Max. Marks: 100

Duration: 3 Hours

PART A		
Answer all questions, each carries 3 marks		
1.	Compare interlaced scanning and progressive scanning.	3
2.	What is the maximum video signal frequency in PAL TV system? How is it obtained?	3
3.	Mention the differences between DVB-C and DVB-S modulators.	3
4.	A DVB-C coaxial system uses 64QAM modulation with symbol rate 69 Mega symbols/s. Roll-off factor used is 0.15. Compute the gross data rate.	3
5.	Write short notes on coded OFDM.	3
6.	What is the function of the Ensemble Transport Interface (ETI) in DAB system? Explain.	3
7.	With a suitable example, illustrate run length encoding.	3
8.	Define discrete cosine transform. How is it important in signal compression?	3
9.	List the essential features of LCD screen compared to CRT/plasma displays.	3
10.	Differentiate between virtual reality and augmented reality.	3
		10x3=30
PART B		
Answer any one full question from each module carries 14 marks.		
MODULE 1		
11a	Sketch the frequency spectrum of typical PAL TV system. Show the bandwidth, vision carrier, sound carrier and guard band frequencies.	7
11b	Explain the packetized elementary streams in MPEG	7
OR		
12a	What is the need of vertical sync pulses and equalising pulses in PAL	7

	TV system? Explain with necessary diagrams.	
12b	Explain how program synchronisation is achieved in MPEG-2.	7
MODULE II		
13a	With a block diagram explain DVB-C modulator.	7
13b	With a block diagram explain the basic units in digital receiver/decoder set-top-box in digital TV.	7
OR		
14a	How DVB-T modulator can be implemented using IFFT blocks? Explain.	7
14b	Explain the requirements of a standard on digital video broadcasting for hand held mobile terminals.	7
MODULE III		
15a	Explain the details of physical layer in DAB.	7
15b	Compare DAB and DVB.	
OR		
16a	With a block diagram explain DAB modulator and transmitter.	7
16b	Describe the essential features of Digital Radio Mondiale.	7
MODULE IV		
17a	Explain subband coding technique in layers I,II of MPEG1, MPEG 2.	7
17b	With relevant details illustrate how the principle differential pulse code modulation can be applied in MPEG 1 and MPEG 2 video compression methods.	7
OR		
18a	Explain a technical model for human ear, which will help in audio coding. How this principle can be applied for developing an audio coding scheme for compression.	7
18b	Explain any one type of transform coding principle for video compression.	7
MODULE V		
19a	With a diagram explain the principle of working of a two layer organic LED device.	7
19b	Explain the advantages and disadvantages of plasma displays.	7
OR		
20a	With a neat diagram explain the working of any one type of cathode ray tube.	7
20b	Explain the applications of virtual reality technology.	7

APJ ABDUL KALAM
TECHNOLOGICAL
UNIVERSITY

SEMESTER VII

MINOR



ECD481	MINIPROJECT	CATEGORY	L	T	P	CREDIT
		PWS	0	0	3	2

Preamble: The course aims

- To estimate the ability of the students in transforming the theoretical knowledge studied in to a working model of an electronic system
- For enabling the students to gain experience in organisation and implementation of small projects.
- Design and development of Small electronic project based on hardware or a combination of hardware and software for electronics systems.

Course Plan

In this course, each group consisting of three/four members is expected to design and develop a moderately complex electronic system with practical applications, this should be a working model. The basic concept of product design may be taken into consideration.

Students should identify a topic of interest in consultation with Faculty/Advisor. Review the literature and gather information pertaining to the chosen topic. State the objectives and develop a methodology to achieve the objectives. Carryout the design/fabrication or develop codes/programs to achieve the objectives. Demonstrate the novelty of the project through the results and outputs. The progress of the mini project is evaluated based on a minimum of two reviews.

The review committee may be constituted by the Head of the Department. A project report is required at the end of the semester. The product has to be demonstrated for its full design specifications. Innovative design concepts, reliability considerations, aesthetics/ergonomic aspects taken care of in the project shall be given due weight.

Course Outcomes

CO1	Be able to practice acquired knowledge within the selected area of technology for project development.
CO2	Identify, discuss and justify the technical aspects and design aspects of the project with a systematic approach.
CO3	Reproduce, improve and refine technical aspects for engineering projects.
CO4	Work as a team in development of technical projects.
CO5	Communicate and report effectively project related activities and findings.

Mapping of course outcomes with program outcomes

	PO 1	PO 2	PO 3	PO 4	PO 5	PO 6	PO 7	PO 8	PO 9	PO 10	PO 11	PO 12
CO 1	3	3	3	2		3						2
CO 2	3	3	3	2		3					3	2
CO 3	3	3	3	2		3					3	2
CO 4								3		3	3	2
CO 5								3	3	3		2

Evaluation

The internal evaluation will be made based on the product, the report and a viva- voce examination, conducted by a 3-member committee appointed by Head of the Department comprising HoD or a senior faculty member, Academic coordinator for that program, project guide/coordinator.

The Committee will be evaluating the level of completion and demonstration of functionality/specifications, presentation, oral examination, work knowledge and involvement.

Mark distribution

Total Marks	CIE	ESE	ESE Duration
150	75	75	1 hour

Split-up of CIE

Component	Marks
Attendance	10
Marks awarded based on guide's evaluation	15
Project Report	10
Evaluation by Committee	40

Split-up of ESE

Component	Marks
Level of completion	10
Demonstration of functionality	25
Project Report	10
Viva-voce	20
Presentation	10

APJ ABDUL KALAM
TECHNOLOGICAL
UNIVERSITY

SEMESTER VII

HONOURS



ECT495	RF MEMS	CATEGORY	L	T	P	CREDIT
		VAC	3	1	0	4

Preamble: This course introduces students to the rapidly emerging, area of MEMS with special emphasis on its applications in RF and wireless engineering

Prerequisite: Nil

Course Outcome: After the successful completion of the course the student will be able to

CO1	Understand the various fabrication techniques and actuation mechanisms used in RF -MEMS design and apply them in practical situations
CO2	Explain the principle of operation of MEMS switches
CO3	Understand the construction and principle of operation of micromachined inductors and capacitors
CO4	Understand the construction and principle of operation of micromachined RF filters and phase shifters
CO5	Analyse the performance improvement of antenna due to micromachining techniques.
CO6	Identify the constraints in integration and packaging of RF MEMS devices

Mapping of course outcomes with program outcomes

	PO1	PO2	PO3	PO4	PO5	PO6	PO7	PO8	PO9	PO10	PO11	PO12
CO1	3	3										
CO2	3	3										
CO3	3	3										
CO4	3	3										
CO5	3	3										
CO6	3	3					2					

Assessment Pattern

Bloom's Category	Continuous Assessment Tests		End Semester Examination
	1	2	
Remember	10	10	20
Understand	30	30	60
Apply	10	10	20
Analyse			
Evaluate			
Create			

Mark distribution

Total Marks	CIE	ESE	ESE Duration
150	50	100	3 hours

Continuous Internal Evaluation Pattern:

Attendance	: 10 marks
Continuous Assessment Test (2 numbers)	: 25 marks
Assignment/Quiz/Course project	: 15 marks

End Semester Examination Pattern: There will be two parts; Part A and Part B. Part A contain 10 questions with 2 questions from each module, having 3 marks for each question. Students should answer all questions. Part B contains 2 questions from each module of which student should answer any one. Each question can have maximum 2 sub-divisions and carry 14 marks.

Course Level Assessment Questions

Course Outcome 1 (CO1): Understand the various fabrication techniques and actuation mechanisms used in RF -MEMS design and apply them in practical situations

1. Explain why Silicon evolved as the ideal substrate material for MEMS fabrication.
2. Explain any two thin film deposition processes as applied to MEMS fabrication.
3. Discuss the various fabrication challenges associated with surface micromachining.
4. List five applications of RF MEMS in our daily lives.
5. With a neat sketch explain the principle of operation of a MEMS piezoelectric actuator.

Course Outcome 2 (CO2): Explain the principle of operation of MEMS switches

1. Explain the various parameters to be considered in the design of RF switches
2. With neat sketches explain the construction and working of a shunt type RF MEMS switch

Course Outcome 3(CO3): Understand the construction and principle of operation of micromachined inductors and capacitors

1. With neat sketches explain one application each of gap-tuning and area tuning capacitors
2. Explain how inductance of micro machined inductors can be varied

Course Outcome 4 (CO4): Understand the construction and principle of operation of micromachined RF filters and phase shifters

1. Sketch and explain the principle of operation of a surface acoustic wave filter
2. Sketch and explain the principle of operation of any two types of micromachined Phase Shifters

Course Outcome 5 (CO5): Analyse the performance improvement of antenna due to micromachining techniques

1. Analytically justify the need for micro machined antennas. How can its performance be improved?
2. Explain the basic characteristics and design of microstrip antenna

Course Outcome 6 (CO6): Identify the constraints in integration and packaging of RF MEMS devices

1. List the types of MEMS packages
2. Explain the reliability issues associated with RF MEMS packaging

SYLLABUS

MODULE I

Introduction: RF MEMS for wireless applications, MEMS technology and fabrication, mechanical modeling of MEMS devices, MEMS materials and fabrication techniques- surface micromachining, Bulk micromachining, LIGA, Actuation Mechanisms in MEMS, Piezoelectric, Electrostatic, Thermal, Magnetic.

MODULE II

MEMS Switches: Introduction to MEMS switches; Capacitive shunt and series switches: Physical description, circuit model and electromagnetic modeling; Techniques of MEMS switch fabrication and packaging; Design of MEMS switches

MODULE III

Inductors and Capacitors: Micromachined passive elements; Micromachined inductors: Effect of inductor layout, reduction of stray capacitance of planar inductors, folded inductors, variable inductors and polymer-based inductors; MEMS Capacitors: Gap-tuning and area-tuning capacitors, dielectric tunable capacitors.

MODULE IV

RF Filters and Phase Shifters: Principle of operation of - micromachined filters, surface acoustic wave filters, micromachined filters for millimeter wave frequencies; Various types of MEMS phase shifters; Ferroelectric phase shifters

MODULE V

Micromachined antennas: Micromachining techniques to improve antenna performance, reconfigurable antennas.

Integration and Packaging: Role of MEMS packages, types of MEMS packages, module packaging, packaging materials and reliability issues.

Text Books:

1. Vijay Varadan, K. J. Vinoy, K. A. Jose, "RF MEMS and Their Applications", Wiley, 2003.
2. Hector J. De Los Santos, "RF MEMS Circuit Design for Wireless Applications", Artech House, 2002

References

1. Gabriel M. Rebeiz, "RF MEMS: Theory, Design, and Technology", Wiley, 2003
2. Eun Sok kim "Fundamentals of Micro electro mechanical Systems (MEMS)" McGraw Hill

Course Contents and Lecture Schedule

No	Topic	No. of Lectures
1	Introduction to RF MEMS: RF MEMS for wireless applications, ,	1
	MEMS technology and fabrication	1
	mechanical modeling of MEMS devices,	2
	MEMS materials	2
	MEMS fabrication techniques – Surface - Bulk Micromachining and LIGA	2
	Actuation Mechanisms in MEMS, Piezoelectric, Electrostatic, Thermal, Magnetic.	2
2	Introduction to MEMS switches	2
	Capacitive shunt and series switches: Physical description	2
	circuit model and electromagnetic modeling;	2
	Techniques of MEMS switch fabrication and packaging	2
	Design of MEMS switches	2
3	Inductors and Capacitors: Micromachined passive elements;	3
	Micromachined inductors: Effect of inductor layout reduction of stray capacitance of planar inductors	2
	folded inductors, variable inductors and polymer-based inductors	2
	MEMS Capacitors: Gap-tuning and area-tuning capacitors, dielectric tunable capacitors	2
4	RF Filters and Phase Shifters: Principle of operation - micromachined filters,	2
	surface acoustic wave filters,	2
	micromachined filters for millimeter wave frequencies	2
	Various types of MEMS phase shifters; Ferroelectric phase shifters	2

5	Micromachined antennas: Micromachining techniques to improve antenna performance	2
	reconfigurable antennas.	2
	Integration and Packaging: Role of MEMS packages, types of MEMS packages	2
	module packaging, packaging materials and reliability issues.	2

Model Question Paper

**A P J ABDUL KALAM TECHNOLOGICAL UNIVERSITY
SEVENTH SEMESTER B TECH DEGREE EXAMINATION
COURSE: ECT495 RF MEMS**

Time: 3 Hrs**Max. Marks: 100****PART A***Answer All Questions*

- 1 List three applications of MEMS technology in RF communication devices 3
- 2 Explain why electrostatic actuation technique is preferred over magnetic actuation in MEMS devices. 3
- 3 List the advantages of cantilever switches 3
- 4 Mention the differences between series and shunt RF MEMS switches 3
- 5 Explain one key parameter used in the design of MEMS inductors 3
- 6 Which of the two MEMS capacitors - Area tuning and Gap tuning is preferred and why? 3
- 7 Explain the significance of Q factor in the design of MEMS filters 3
- 8 Explain one practical application of Phase shifters 3
- 9 What are the parameters to be optimised in the design of micro strip antennas 3
- 10 State three reliability issues in RF Microsystems packaging 3

PART B*Answer one question from each module. Each question carries 14 marks.***Module I**

- 11(A) Design a capacitor-based MEMS device for actuating the air-bag system in a passenger car. Show relevant diagrams. Compare it with a piezo electric based MEMS. 7
 - 11(B) With neat sketches explain the LIGA process. Also mention two applications of the same. 7
- OR**
- 12(A) With neat sketches explain the steps in fabrication of two structures using bulk and surface micromachining. 8
 - 12(B) An ink jet printer needs a fast and efficient mechanism for ink dispensing. 6

Design a MEMS based system for this application. Give required sketches and equations.

Module II

- 13(A) Explain the various parameters to be considered in the design of RF switches. 7
- 13(B) With relevant equations explain how the pull-in voltage of cantilever beam type switches can be reduced. What are the integration and biasing issues for RF switches 7

OR

- 14(A) With neat sketches explain the construction and working of a shunt type RF MEMS switch. Explain the RF MEMS design flow with a neat sketch. 10
- 14(B) List the approaches used for low actuation voltage switching. 4

Module III

- 15(A) With neat sketches describe the fabrication process of any micro machined inductor 7
- 15(B) Explain how the capacitance can be varied for micro machined capacitors. 7
- OR
- 16(A) With neat sketches explain one application each of gap-tuning and area tuning capacitors. 6
- 16(B) With the help of relevant equations show how inductance is varied in micro machined inductors. 8

Module IV

- 17(A) Explain the realization of micro machined filters using resonators. 7
- 17(B) Explain the principle of operation of any two types of phase shifters 7
- OR
- 18(A) With neat sketches explain the working of micromechanical filters using comb drives. 10
- 18(B) Detailing the basic principles, mention two applications of MEMS phase shifters 4

Module V

- 19(A) Explain the significance of reconfigurable antennas in satellite communication 7
- 19(B) Discuss the reliability issues of MEMS packaging materials. 7
- OR
- 20(A) Explain the need for micro machined antennas with analytical justification. How can its performance be improved? 6
- 20(B) Explain different types of MEMS packages 8

ECT497	DESIGN AND ANALYSIS OF ANTENNAS	CATEGORY	L	T	P	CREDIT
		VAC	4	0	0	4

Preamble: This course aims to impart knowledge on the basic parameters, matching techniques, design and working of various broad band antennas, practical antennas, antenna arrays and its radiation patterns. It also introduces standard software to design antennas with a set of given specifications.

Prerequisite: ECT 302 ELECTROMAGNETICS, ECT 401 MICROWAVE AND ANTENNAS

Course Outcomes: After the completion of the course the student will be able to:

CO1-K2	Understand the concept of radiation mechanism, antenna parameters and antenna matching techniques.
CO2-K2	Illustrate the far filed pattern of different types of antennas.
CO3-K3	Analyze different types of broad band antennas and its radiation patterns.
CO4-K3	Design of various practical antennas, antenna arrays and field patterns.
CO5-K3	Familiarize Antenna Design Software and design microstrip patch antenna.

Mapping of course outcomes with program outcomes:

	PO1	PO2	PO3	PO4	PO5	PO6	PO7	PO8	PO9	PO10	PO11	PO12
CO1	3	2		1								2
CO2	3	2	2	1	2							2
CO3	3	2	3	2	3							2
CO4	3	2	3	2	3							2
CO5	3	2	3	2	3							2

Assessment Pattern:

Bloom's Category	Continuous Assessment Tests		End Semester Examination
	1	2	
Remember			
Understand K2	20	20	40
Apply K3	30	30	60
Analyse			
Evaluate			
Create			

Mark distribution:

Total Marks	CIE	ESE	ESE Duration
150	50	100	3 Hours

Continuous Internal Evaluation Pattern:

Attendance	: 10 marks
Continuous Assessment Test (2 numbers)	: 25 marks
Assignment/Quiz/Course project	: 15 marks

End Semester Examination Pattern**Maximum Marks: 100****Time: 3 hours**

End Semester Examination Pattern: There will be two parts; Part A and Part B. Part A contain 10 questions with 2 questions from each module, having 3 marks for each question. Students should answer all questions. Part B contains 2 questions from each module of which student should answer any one. Each question can have maximum 2 subdivisions and carry 14 marks.

Course Level Assessment Questions**Course Outcome 1 (CO1):**

1. Explain the steps involved in the design of a T-match circuit.
2. With the help of neat sketches explain the working of a Rhombic Antenna and its features.
3. Explain omega match.
4. Calculate the Directivity of an antenna with field pattern given by,

$$E = E_0 = \frac{\mu}{4\pi r} e^{-jkr} \cos^2 \phi \sin^2 \theta, 0 \leq \theta \leq \pi, 0 \leq \phi \leq 2\pi$$

5. Derive the vector potential for an electric current source J.
6. Explain the optimum design of rhombic antenna.
7. Derive expressions for the Far Field components and Radiation Resistance and Directivity of a half wave dipole antenna.

Course Outcome 2 (CO2):

1. Explain the axial mode and normal mode of operation of a helical antenna.
2. Derive the expressions for the fields radiated by a circular loop antenna.
3. Explain field equivalence principle and give the step to form an equivalent and aperture problem.
4. Explain solution of Hallen's Integral equation using delta gap model.

Course Outcome 3 (CO3):

1. Discuss about any two feeding techniques for Microstrip Antenna.
2. List the important features of a Yagi-Uda Antenna.
3. Design an aperture antenna, with uniform illumination, so that the directivity is maximized at an angle 30° from the normal to the aperture. Determine the optimum dimension and its associated directivity when the aperture is (i) square (ii) circular.
4. Design a Microstrip patch antenna for 2.4 GHz. The patch substrate has a dielectric of 2.2 and with height 2.2 mm.

Course Outcome 4 (CO4):

1. Explain the working of Lens Antenna. What do man by zoning in Lens Antenna?
2. Design a broad side Dolph-Tschebycheff array of 10 elements with spacing d between the elements and with a major to minor lobe ratio of 26 dB. Find the excitation coefficients and form the array factor.
3. Derive general expression for array factor of non-isotropic antennas.
4. Derive expression for array factor of N isotropic sources for end-fire array and also the expression for major lobe, minor lobes and Nulls of the array.
5. Calculate the half-power beam width and directivity for the Dolph-Tchebyscheff array of lobe ratio 26 dB for a spacing of $\lambda/2$ between the elements.
6. Design an 8 element broadside array of isotropic sources having $\lambda/2$ spacing between the elements .The pattern is to be optimized with a side lobe -25dB down the minor lobe maxima.

Course Outcome 5 (CO5):

1. Design a rectangular patch antenna operates at 5.5GHz. Use FR4/Duroid RT5870 as the substrate of patch antenna. Determine the thickness from data sheet. Write a procedure in order to design desired antenna by giving all equations , dimensions and simulation results (using MATLAB/HFSS/CST Microwave Studio or any Open software)
2. By using the rectangular patch antenna which is designed in Question no 1 as unit element, designing 1x4 array antennas at 5.5GHz on FR4/Duroid RT 5870 substrate. Determine the optimum distance between the unit element using HFSS and also give simulation results (radiation pattern, VSWR plot etc.).

Syllabus

Module	Course contents	Hours
I	Review of Antenna Parameters: -Polarization, Input impedance, Gain. Relation between radiation fields and magnetic vector potential – Helmholtz equation and Lorentz conditions. Antenna matching –T match, Baluns, Gamma and Omega match. Review of dipole antennas (short dipole and arbitrary length), Monopole antennas, Vand rhombic antennas. Folded dipole and it's properties.	9
II	Analysis of Circular Loop and Biconical Antenna. Helical Antennas (normal mode and axial mode) – relation for far fields, radiation resistance and gain. Current induced in a dipole antenna – Pocklington and Hallen's integral equations. Solution of Hallen's integral equation for current induced in a dipole antenna for delta gap model.	9
III	Near fields of linear antennas, self and mutual impedance, arrays of parallel dipoles, Yagi-Uda antennas. Aperture antenna – Field equivalence principle. Radiation from open-ended wave-guides, horn antennas, horn radiation fields, horn directivity, optimum horn design, Rectangular micro-strip antennas –field analysis and design. Designing an antenna with a set of given specifications using standard software (MATLAB/HFSS/CST Microwave Studio or any Open software)	10
IV	Parabolic reflector antennas, gain and beam width of reflector antennas, aperture-field and current distribution methods, radiation patterns of reflector antennas, dual-reflector antennas, lens antennas -hyperbolic lens and zoned lens. Frequency independent antennas – Rumsey Principle – Spiral Antennas. Design of log periodic dipole arrays.	8
V	Antenna arrays – General expression for array factor. Grating lobes. One dimensional arrays- Broad side, end fire and Chebyshev arrays. Concept of beam steering. Design of array using Schelkunnof's zero placement method and Fourier series method. Woodward-Lawson frequency-sampling design, Narrow beam design and Butler matrix beam former. Adaptive Beam forming. 2D arrays – Rectangular and Circular array.	9

Text Books:

1. Sopholes J. Orfanidis – Electromagnetic waves and antennas. Available at: <http://eceweb1.rutgers.edu/~orfanidi/ewa/>
2. Consrantive A Balanis -Antenna Theory - Analysis and Design – 2/e John Wiley & Sons.
3. John D. Krans, Ronald J. Marhefka : Antennas for all Applications , 3/e, TMH
4. Thomas A Milligan – Modern Antenna Design, 2/e John Wiley & Sons.

References:

1. Collin R.E, Antennas & Radio Wave Propagation, McGraw Hill. 1985.
2. Jordan E.C. & K. G. Balmain, Electromagnetic Waves & Radiating Systems, 2/e, PHI.
3. Raju G.S.N., Antenna and Wave Propagation, Pearson, 2013.
4. Sisir K.Das & Annapurna Das, Antenna and Wave Propagation, McGraw Hill, 2012

Course Contents and Lecture Schedule.

No	Topic	No.of Lectures
Module I		
1.1	Basic antenna parameters (all parameters and related simple problems), Relation between parameters (derivation required)	1
1.2	Relation between radiation fields and magnetic vector potential – Helmholtz equation and Lorentz conditions.	2
1.3	Antenna matching – T match, Baluns, Gamma and Omega match.	2
1.4	Review of dipole antennas (short dipole and arbitrary length),	2
1.5	Monopole antennas, V and rhombic antennas. Folded dipole and its properties.	2
Module II		
2.1	Analysis of Circular Loop and Biconical Antenna.	2
2.2	Helical Antennas (normal mode and axial mode) – relation for far fields, radiation resistance and gain.	2
2.3	Current induced in a dipole antenna – Pocklington and Hallen's integral equations.	3
2.4	Solution of Hallen's integral equation for current induced in a dipole antenna for delta gap model.	2
Module III		
3.1	Near fields of linear antennas, self and mutual impedance, arrays of parallel dipoles, Yagi-Uda antennas.	2
3.2	Aperture antenna – Field equivalence principle.	2
3.3	Radiation from open-ended wave-guides, horn antennas, horn radiation fields, horn directivity, optimum horn design,	2
3.4	Rectangular micro-strip antennas – Field analysis and design.	2
3.5	Designing an antenna with a set of given specifications using standard software (MATLAB/HFSS/CST Microwave Studio or any Open software).	2
Module IV		
4.1	Parabolic reflector antennas, gain and beam width of reflector antennas, aperture-field and current distribution methods, radiation patterns of reflector antennas,	2
4.2	Dual-reflector antennas, lens antennas -hyperbolic lens and zoned lens.	2
4.3	Frequency independent antennas – Rumsey Principle – Spiral Antennas.	2
4.4	Design of log periodic dipole arrays.	2
Module V		
5.1	Antenna arrays – General expression for array factor. Grating lobes.	1
5.2	One dimensional arrays- Broad side, end fire and Chebyshev arrays. Concept of beam steering.	2

5.3	Design of array using Schelkunnof's zero placement method and Fourier series method.	2
5.4	Woodward-Lawson frequency-sampling design, Narrow beam design and Butler matrix beam former.	2
5.5	Adaptive Beam forming. 2D arrays – Rectangular and Circular array.	2

Simulation Assignments (ECT 477)

The following simulation assignments can be done with MATLAB/HFSS/CST Microwave Studio or any Open software.

- Design a rectangular microstrip antenna (using MATLAB) for 1.8 GHz with RT-Duroid 5880 FR4 substrate having permittivity 4.4, loss tangent=0.001 and $h=1.6\text{mm}$ and also plot 3D, 2D radiation patterns and VSWR.
- The dimensions of a rectangular microstrip antenna are: $L=3.733\text{cm}$ and $W=3.973\text{ cm}$. The substrate height $h=1.6\text{mm}$ and dielectric constant = 4.4.If operating frequency is 1.8 GHz.Write a MATLAB program to calculate
 - (a) The input impedance
 - (b) The position of the inset feed point for matching to 50 ohm feeder line.



Model Question paper**APJ ABDUL KALAM TECHNOLOGICAL UNIVERSITY**

SEVENTH SEMESTER B. TECH DEGREE EXAMINATION

Course Code: ECT497**Course Name: DESIGN AND ANALYSIS OF ANTENNAS**

Max. Marks: 100

Duration: 3 Hours

PART A*(Answer All Questions)*

- 1 Using Lorentz condition show that $\nabla^2 A + k^2 A = -\mu J$ (3)
- 2 Explain design procedure of Gamma match. (3)
- 3 Derive expression for input impedance of a folded dipole antenna. (3)
- 4 Derive radiated fields for a circular loop of constant current. (3)
- 5 Explain the delta gap model in dipole antennas. (3)
- 6 Derive the expression for far field pattern of an open ended wave guide. (3)
- 7 Discuss about the Frequency Sampling Technique for Array Design. (3)
- 8 Explain the working of Spiral Antenna. Derive appropriate expressions. (3)
- 9 Design an Antenna Array using Schelkunoff's Zero Placement technique. (3)
- 10 Explain Butler Matrix Beam Forming. (3)

PART B*(Answer one question from each module. Each question carries 14 marks)***MODULE I**

- 11 a) Derive the relation between magnetic vector potential and radiation fields in antennas, stating clearly Helmholtz equation and Lorentz conditions. (9)
- b) An antenna with overall length $l = 5\lambda$ the observations are made at $r = 60\lambda$. Find the errors in phase and amplitude using far field approximation. (5)

OR

- 12a) Derive expressions for the Far Field components and Radiation Resistance and Directivity of a short dipole antenna. (6)
- b) Derive the self and mutual impedance of two parallel Centers driven coupled dipole antennas. (8)

MODULE II

- 13 a) Design an axial mode helical antenna for directivity 28 dBi for operating at 600 MHz. (5)
Calculate the radiation resistance, HPBW, BWFN and bandwidth of the designed antenna.
- b) Derive Pocklington's and Hallen's Integral Equation. Explain their significance. (9)

OR

- 14 a) Explain the Field Equivalence Principle in detail. (5)
- b) Derive the expressions for power density, radiation resistance, and directivity of Circular loop antenna. (9)

MODULE III

- 15 a) Design a rectangular Microstrip antenna resonating at 2 GHz. The antenna uses a substrate with a dielectric of 10.2 and the height of the substrate is 0.3 cm. (8)
- b) Derive expressions for the Directivity of a Horn Antenna. (6)

OR

- Design a Yagi-Uda array with a directivity of 9.2 dB at $f_0 = 50\text{MHz}$. The desired (7)
- 16a) diameter of the parasitic elements is 2.54 cm and of the metal supporting boom 5.1 cm. Find the element spacing, lengths and total array length.
- b) State Huygens' Principle and discuss field equivalence in aperture antennas. (7)

MODULE IV

- 17a) Design a LPDA with $\tau = 0.85$, $\sigma = 0.03$ for the frequency range 15-45 MHz. (7)
- b) Explain the working of a parabolic dish antenna. Write down the expression for gain, HPBW and BWFN. (7)

OR

- 18 a) Derive Rumsey Principle for frequency independent antennas. (7)
- b) Why equiangular spiral antenna and log periodic antennas are called frequency independent antennas. Explain their working. (7)

MODULE V

- 19 a) Design an antenna array using Schelkunoff's zero placement method. (7)
- b) Design a 5 element Dolph-Tschebycheff array with peak side lobe level 22 dB. (7)

OR

- 20 a) Design an antenna array using Woodward-Lawson Frequency Sampling technique. (8)
- b) Derive the array factor of 90° corner reflector. (6)

ECT499	MULTIRATE SIGNAL PROCESSING AND WAVELETS	CATEGORY	L	T	P	CREDIT
		VAC	3	1	0	4

Preamble: The aim of this course is to introduce the idea of wavelets, and the related notions of time frequency analysis, of time-scale analysis, and to describe the manner in which technical developments related to wavelets have led to numerous applications. The concepts of multirate filter banks is also introduced. The relation between wavelets and multirate systems is brought out to illustrate how wavelets may actually be realized in practice.

Prerequisite: ECT 303 Digital Signal Processing

Course Outcomes: After the completion of the course the student will be able to

CO 1	Understand the concepts, properties and interconnection of Multirate systems, Wavelets and Filterbanks and apply them in the analysis of signal processing systems.
CO 2	Construct wavelets and multirate systems using the time domain and the frequency domain approaches.
CO 3	Apply the wavelet transform, wavelet packet transform and its variants as a tool in 1-D and 2-D signal analysis and processing.

Mapping of course outcomes with program outcomes

	PO 1	PO 2	PO 3	PO 4	PO 5	PO 6	PO 7	PO 8	PO 9	PO 10	PO 11	PO 12
CO 1	3	3	3	3								2
CO 2	3	3	3	3								2
CO 3	3	3	3	3	3			1	2	2	1	2

Assessment Pattern

Bloom's Category		Continuous Assessment Tests		End Semester Examination
		1	2	
Remember	K1	10	10	10
Understand	K2	20	10	20
Apply	K3	10	20	50
Analyse	K4	10	10	20
Evaluate				
Create				

Mark distribution

Total Marks	CIE	ESE	ESE Duration
150	50	100	3 hours

Continuous Internal Evaluation Pattern:

Attendance	: 10 marks
Continuous Assessment Test (2 numbers)	: 25 marks
Assignment/Quiz/Course project	: 15 marks

End Semester Examination Pattern: There will be two parts; Part A and Part B. Part A contain 10 questions with 2 questions from each module, having 3 marks for each question. Students should answer all questions. Part B contains 2 questions from each module of which student should answer any one. Each question can have maximum 2 sub-divisions and carry 14 marks.

Course Level Assessment Questions

Course Outcome 1 (CO1): Understand the concepts, properties and interconnection of Multirate systems, Wavelets and Filter banks and apply them in the analysis of signal processing systems.

1. Explain the basic building blocks of a multirate/ multi resolution analysis system.
2. Analyse the frequency domain behavior of the rate conversion operations to build analysis and synthesis filters of a filter bank.
3. Analyse the time-frequency behaviour of signals through various analysis tools such as Fourier Transform, Short Time Fourier Transform(STFT) and wavelet transform and compare their properties.
4. What are the properties of a wavelet basis functions and what are the advantages of representing signals using them.

Course Outcome 2 (CO2): Construct wavelets and multirate systems using the time domain and the frequency domain approaches

1. Construct different families of wavelets using the filter bank approach.
2. Construct different families of wavelets using frequency domain approach.
3. Establish the relationship between filterbanks and wavelets to construct efficient wavelet based analysis-synthesis systems.

4. Design appropriate analysis and synthesis filters using the z-domain analysis that satisfy the properties of a wavelet system.

Course Outcome 3 (CO3): Apply the wavelet transform, wavelet packet transform and its variants as a tool in 1-D and 2-D signal analysis and processing.

1. Explain the wavelet packet transform and its implantation using filterbanks.
2. Explain the construction of the filter bank for the analysis of 2-D signals.
3. How will you choose wavelets for various applications? What properties of wavelets are suited for different applications? Analyse and study with respect to the application point of view

SYLLABUS

Module 1: Basics of Multirate processing and Filter banks

Introduction to multiresolution and multirate signal processing with some example applications, Multirate System Fundamentals: Basic multirate operations – Decimation and Interpolation, Transform domain analysis of Decimators and Interpolators, Decimation and Interpolation filters, Fractional sampling rate alteration Interconnection of decimators and interpolators, The Noble Identities.

Introduction to digital filter banks, The DFT filter bank, Two Channel Quadrature Mirror Filterbank (QMF), Two channel Conjugate Quadrature Filter Bank (CQF). Perfect Reconstruction.

Module 2: Introduction to Wavelet Transform

The Uncertainty Principle - Time-bandwidth product uncertainty, The time frequency plane and its tilings, Short Time Fourier Transform, The Gabor Transform and its generalization, Wavelet Transform in general and origin of Wavelets. The Continuous Wavelet Transform (CWT), Condition of admissibility and its implications.

Introduction to Discrete Wavelet Transform (DWT), DWT from CWT, Logarithmic Scale Discretization and Dyadic Discretization, Families of wavelets: Orthogonal and biorthogonal wavelets, Vanishing moments and regularity.

Module 3: The Multiresolution Analysis (MRA), Wavelets and Filter Banks

The Multiresolution Analysis: The Dyadic Haar Multiresolution Analysis - The Haar Scaling Functions and Function spaces, Nested spaces, The Haar Wavelet function, Orthogonality of the Haar Scaling and Wavelet functions. Relating Scaling and Wavelet functions of Haar and Filters, The Haar Filter Bank, Z-domain analysis of Haar filter bank.

The Daubechies' family of MRA, Daubechies' Filter banks, Relating QCF filter banks and Daubechies' wavelets.

Module 4: Biorthogonal Wavelets

Introduction to biorthogonal vector space, Biorthogonal Wavelet Systems, Signal

representation using Biorthogonal Wavelet System, Construction of Biorthogonal wavelets
 Design of Wavelet systems using frequency domain approach – Frequency domain
 characterisation of filter coefficients, Design of Daubechies Wavelets using frequency
 domain approach, JPEG 2000 5/3 filter bank and Spline MRA.

Module 5: Wavelet packets and 2-D DWT

The wavelet packet transform, Best wavelet packet tree, Noble identities and the Haar wave
 Packet Transform. Introduction to 2-D DWT, Wavelet transform of an image, The Embedded
 Zero-tree Wavelet (EZW) Coding. Applications of wavelets in audio & image compression
 and denoising.

Text Books

1. P. P. Vaidyanathan, Multirate Systems and Filter Banks, Pearson Education, 2006.
2. K. P. Soman, K. I. Ramachandran, "Insight Into Wavelets - From Theory to Practice",
 Prentice Hall of India, 3rd Edition, Eastern Economy Edition, Prentice Hall of India
 Private Limited, 2010. Video lectures and Transcripts: Adv. Digital Signal
 Processing: Multirate and Wavelet NPTEL Lecture series -
<https://nptel.ac.in/courses/117/101/117101001/>

Reference Books

1. Gilbert Strang and Truong Q. Nguyen, Wavelets and Filter banks, 2nd Edition,
 Wellesley- Cambridge Press, 1998
2. Raghuvver M. Rao, Ajit S. Bopardikar, "Wavelet Transforms: Introduction to Theory
 and Applications, Prentice Hall, 1998.
3. N.J. Fliege, Multirate Digital Signal Processing, John Wiley, 1999.

Course Contents and Lecture Schedule

No	Topic	No. of Lectures
1	Basics of Multirate processing and Filter banks	
1.1	Introduction to multiresolution and multirate signal processing with some example applications.	1
1.2	Multirate System Fundamentals: Basic multirate operations – Decimation and Interpolation, Transform domain analysis of Decimators and Interpolators, Decimation and Interpolation filters.	2
1.3	Fractional sampling rate alteration	1
1.4	Interconnection of decimators and interpolators, The Noble Identities.	1
1.5	Introduction to digital filter banks, The DFT filter bank.	2
1.6	Two Channel Quadrature Mirror Filterbank (QMF)	1
1.7	Two Channel Conjugate Quadrature Filter Bank (CQF). Perfect Reconstruction.	2
2	Introduction to Wavelet Transform	

2.1	The Uncertainty Principle - Time-bandwidth product uncertainty, The time frequency plane and its tilings.	2
2.2	Short time Fourier Transform, The Gabor Transform and its generalization, Wavelet Transform in general and origin of Wavelets.	2
2.3	The Continuous Wavelet Transform (CWT), Condition of admissibility and its implications.	2
2.4	Introduction to Discrete Wavelet Transform (DWT), DWT from CWT, Logarithmic Scale Discretization and Dyadic Discretization	1
2.5	Families of wavelets: Orthogonal and biorthogonal wavelets, Vanishing moments and regularity.	2
3	The Multiresolution Analysis (MRA), Wavelets and Filter Banks	
3.1	The Multiresolution Analysis: The Dyadic Haar Multiresolution Analysis - The Haar Scaling Functions and Function spaces, Nested spaces, The Haar Wavelet function, Orthogonality of the Haar Scaling and Wavelet functions.	3
3.2	Relating Scaling and Wavelet functions of Haar and Filters, The Haar Filter Bank, Z-domain analysis of Haar filter bank.	3
3.3	The Daubechies' family of MRA, Daubechies' Filter banks, Relating QCF filter banks and Daubechies' wavelets.	3
4	Biorthogonal Wavelets	
4.1	Introduction to biorthogonal vector space, Biorthogonal Wavelet Systems.	2
4.2	Signal representation using Biorthogonal Wavelet System, Construction of Biorthogonal wavelets	2
4.3	Design of Wavelet systems using frequency domain approach – Frequency domain characterisation of filter coefficients, Design of Daubechies Wavelets using frequency domain approach.	3
4.4	JPEG 2000 5/3 filter bank and Spline MRA.	1
5	Wavelet packets and 2-D DWT	
5.1	The wavelet packet transform, Best Wavelet packet tree, Noble identities and the Haar wave Packet Transform.	3
5.2	Introduction to 2-D DWT, Wavelet transform of an image	3
5.3	The Embedded Zero-tree Wavelet (EZW) Coding.	1
5.4	Applications of wavelets in audio & image compression and denoising	2

Course Projects:

1. Study the spectral characteristics of Down sampler (Decimator) and Up sampler (Interpolator).
2. Implement a 2- channel QMF/QCF filterbank and observe and study the output at every stage of the filter bank.
3. Study the effect of sample rate conversion (Down sampling and Up sampling) on audio data or on your own recorded speech.
4. Generate and plot the scaling and wavelet functions of Daubechies' wavelets using recursion/iterative method.
5. Study the equivalence of Haar multi resolution analysis and Haar filter bank for a piecewise linear function.
6. Implement a biorthogonal 5/3 filter bank used in JPEG2000 standard.
7. Read an image and apply 2-D wavelet transform on it. Observe and study the contribution of various subbands by reconstructing the image using selective subbands.
8. Study and implementation of Wavelet Packet Transform and best wavelet packet tree.
9. Read an image and apply 2-D wavelet transform on it. Apply thresholding on the wavelet coefficients of different subband based on energy of the coefficient and reconstruct the signal. Compute the compression obtained and the quality of the reconstructed image (PSNR) by varying the thresholds.
10. Apply Wavelet transform on noisy data and implement various wavelet based denoising methods



Model Question paper

APJ ABDUL KALAM TECHNOLOGICAL UNIVERSITY
SEVENTH SEMESTER B.TECH DEGREE EXAMINATION,

(Model Question Paper)

Course Code: ECT499

Course Name: MULTIRATE SIGNAL PROCESSING AND WAVELETS

Max. Marks: 100

Duration: 3 Hours

PART A

Answer ALL Questions. Each Carries 3 mark.

1	Illustrate the frequency domain behavior of a decimator.	K2
2	State and prove the noble identities for the multirate systems.	K1
3	Explain dyadic discretization of constructing DWT from CWT	K2
4	Explain Gabor transform. What is its drawback?	K2
5	Explain the concept of nested spaces in multirate Analysis.	K3
6	Establish the relationship between QCF Filterbank and Daubechies wavelet.	K3
7	Explain the concept of biorthogonal vector space	K2
8	When will you go for biorthogonal wavelet transforms rather than orthogonal wavelet transform. Specify any one application where biorthogonal wavelet transform is used.	K2
9	What are the advantages of Wavelet Packet Transform over Wavelet Transform?	K2
10	Give a block schematic of 2-D wavelet decomposition and explain the construction of image subbands.	K2
	PART – B Answer one question from each module; each question carries 14 marks.	
	Module - I	

11	<p>a. Show that the decimator and interpolator are linear time varying systems</p> <p>b. For the system shown in Figure below, find the expression for $y(n)$ in terms of $x(n)$.</p> <p style="text-align: center;"> $x(n) \quad \uparrow 3 \quad \downarrow 2 \quad \downarrow 3 \quad \uparrow 2 \quad y(n)$ </p>	<p>7</p> <p>7</p> <p>CO1 K3</p>
----	---	-------------------------------------

OR		
12	<p>a. Draw the block diagram of a 2-channel Quadrature Mirror Filterbank (QMF) and derive the expression for the output using z-domain analysis. What is the condition for alias cancellation? How will you construct an alias free QMF?</p>	<p>14</p> <p>CO1 K2</p>

Module - II		
13	<p>a. Derive Heisenberg's uncertainty principle relating the time and frequency resolutions. Prove that if the window function is Gaussian, equality holds.</p> <p>b. Briefly explain the difference between Fourier Transform, Short Time Fourier Transform (STFT) & Wavelet Transform.</p>	<p>7</p> <p>CO1 K2</p> <p>7</p> <p>CO1 K3</p>

OR		
14	<p>a. State and prove the admissibility conditions of a wavelet. Check whether the following function is an admissible wavelet?</p> <p>b. $e^{-t^2} \cos \pi t^2$</p>	<p>7</p> <p>7</p> <p>CO2 K4</p>

Module - III		
15	<p>a. Find two level Haar Wavelet transform using the analysis filters $\{h(-k)\} = \begin{bmatrix} 1 & 1 \\ 1 & -1 \end{bmatrix}$ & $\{g(-k)\} = \begin{bmatrix} 1 & -1 \\ 1 & 1 \end{bmatrix}$ for the following sequence. $[1, 0, -3, 2, 1, 0, 1, -2]$</p> <p>Remove from the Wavelet transform, the coefficients between -1 & 1 and then reconstruct the function and compute Mean Squared Error.</p>	<p>14</p> <p>CO2 K3</p>

	OR	
16	<p>Let $\varphi(t)$ and $\psi(t)$ be the Haar scaling and wavelet functions. Let V_j and W_j be the spaces spanned by $\varphi_{j,k}(t) = 2^{j/2} \varphi(2^j t - k)$ and $\psi_{j,k}(t) = 2^{j/2} \psi(2^j t - k)$, respectively. Let $f(t)$ be defined on $0 \leq t < 1$ and given by</p> $f(t) = \begin{cases} -1 & 0 \leq t < 1/4 \\ 4 & 1/4 \leq t < 1/2 \\ 2 & 1/2 \leq t < 3/4 \\ -3 & 3/4 \leq t < 1 \end{cases}$ <ol style="list-style-type: none"> Express f in terms of the basis for V_2. Decompose f into its component parts in W_1, W_0, and V_0. In other words, find the Haar wavelet decomposition for f. Sketch each of the four decompositions.. 	14 CO2 K3
	Module - IV	
17	<p>Prove that in a Bi-orthogonal Wavelet System</p> $\sum_k h(k) = \sum_k \tilde{h}(k) = 2$ $\sum_k \tilde{h}(k) h(k - 2l) = \delta_{l,0}$	14 CO1 K3
	OR	
18	Construct db2 wavelet using time domain approach.	14 CO2 K2
	Module - V	
19	Discuss the application of wavelet analysis in Audio Coding and Signal Denoising. Compare wavelet based denoising technique with FFT based denoising method	14 CO3 K2
	OR	

20	<p>a. Explain the Embedded Zero-tree Wavelet (EZW) algorithm used in image compression.</p>	7 CO3 K2																
b.	<p>For the seven-level decomposition shown below,</p> <table style="margin-left: 40px;"> <tr> <td>21</td> <td>6</td> <td>15</td> <td>12</td> </tr> <tr> <td>-6</td> <td>3</td> <td>6</td> <td>3</td> </tr> <tr> <td>3</td> <td>-3</td> <td>0</td> <td>-3</td> </tr> <tr> <td>3</td> <td>0</td> <td>0</td> <td>0</td> </tr> </table> <p>Find the bit stream or labels generated by the Embedded Zerotree Wavelet (EZW) coder, after three steps of multiple pass procedure. Also, determine the list of significant coefficients.</p>	21	6	15	12	-6	3	6	3	3	-3	0	-3	3	0	0	0	7 CO3 K3
21	6	15	12															
-6	3	6	3															
3	-3	0	-3															
3	0	0	0															

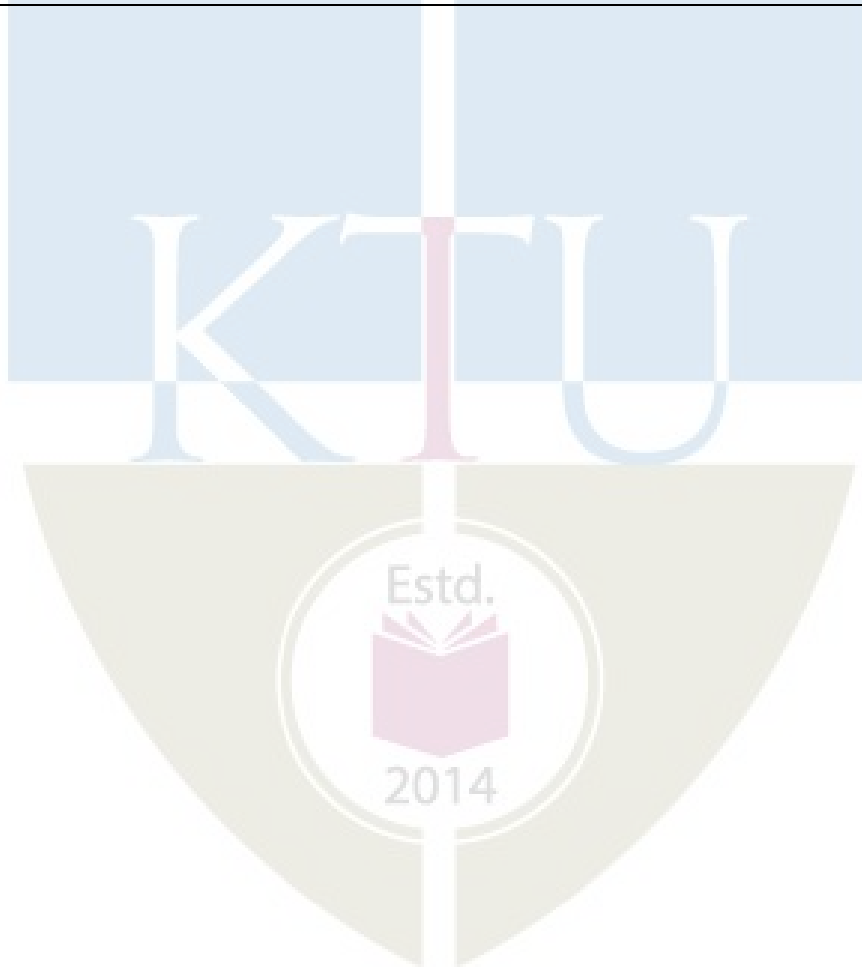

APJ ABDUL KALAM
TECHNOLOGICAL
UNIVERSITY

SEMESTER VIII

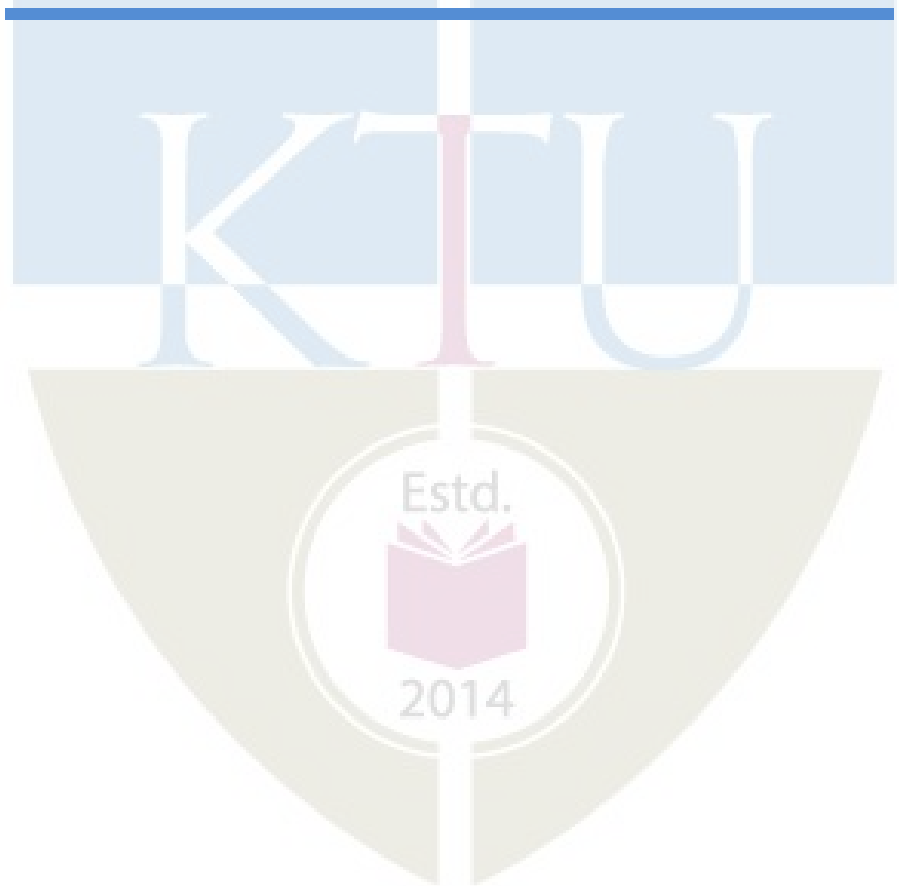

Assessment Pattern

Bloom's Category	Continuous Assessment Tests		End Semester Examination
	1	2	
Remember			
Understand K2	15	15	30
Apply K3	20	20	40
Analyse K4	15	15	30
Evaluate			
Create			

Mark distribution

Total Marks	CIE	ESE	ESE Duration
150	50	100	3 hours

Continuous Internal Evaluation Pattern:

Attendance	: 10 marks
Continuous Assessment Test (2 numbers)	: 25 marks
Assignment/Quiz/Course project	: 15 marks

End Semester Examination Pattern: There will be two parts; Part A and Part B. Part A contain 10 questions with 2 questions from each module, having 3 marks for each question. Students should answer all questions. Part B contains 2 questions from each module of which student should answer any one. Each question can have maximum 2 sub-divisions and carry 14 marks.

Course Level Assessment Questions

Course Outcome 1 (CO1) : Summarize the basics of cellular system and cellular design fundamentals. (K2).

1. List certain challenges in the design of a cellular wireless communication system.
2. A total of 33MHz of bandwidth is allocated to an FDD cellular system which uses two 25kHz simplex channels to provide full-duplex voice & control channels. Compute the number of channels available per cell if the system uses 7-cell reuse.
3. Describe methods to improve coverage and capacity of a cellular system.

Course Outcome 2 (CO2): Describe the wireless channel models and discuss capacity of wireless channels. (K2)

1. Compare and contrast flat-fading and frequency-selective fading channels.
2. How are Doppler spread and coherence time related? What is their significance?
3. Consider a Rayleigh fading channel with average received power of 25dBm. Compute the probability that the received power is below 10dBm.
4. Differentiate between ergodic capacity and capacity with outage.

Course Outcome 3 (CO3): Analyze the performance of the modulation techniques for flat-fading channels and multicarrier modulation. (K4)

1. Under Rayleigh flat-fading, derive an expression for the required average SNR to ensure that outage probability does not below P_{out} .
2. How can subcarrier fading be mitigated?
3. Why is cyclic prefix required in OFDM?

Course Outcome 4 (CO4): Illustrate how receiver performance can be enhanced by various diversity techniques. (K3)

1. Explain receiver diversity technique of maximal ratio combining technique.
2. Describe Alamouti scheme for 2x2 MIMO.
3. Find the outage probability of BPSK modulation at $P_b = 10^{-3}$ for a Rayleigh fading channel with SC diversity for $M = 1$ (no diversity) $M = 2$. Assume equal branch SNRs of 15 dB.

Course Outcome 5 (CO5): Identify advantages of various equalization techniques and multiple-access techniques in wireless communication. (K3)

1. Describe the steps for LMS algorithm.
2. Compare multiple-access schemes TDMA, FDMA and CDMA.
3. Consider a channel with impulse response $h(t) = \exp(-t/T) u(t)$. Find two-tap Zero-forcing equalizer for this channel?

Course Outcome 6 (CO6): Calculate system parameters such antenna height, range, maximum usable frequency in different modes of radio wave propagation. (K3)

1. Derive expression for critical frequency, maximum usable frequency and skip distance (assuming flat earth's surface) for sky wave propagation.
2. A communication system is to be established at a frequency of 50MHz with a transmitter power 1.2kW. The field strength of the directive antenna is 3 times that of a half wave antenna, $h_t = 50\text{m}$, $h_r = 5\text{m}$. A field strength of $80\mu\text{V/m}$ is required to give satisfactory reception. Find the range of the system.

SYLLABUS

Module 1: Introduction to Wireless Communication Systems (8 Hours)

- 1.1 Introduction to Wireless Communication Systems (4):** Generations: 2G, 3G, 4G, 5G. Wireless LAN, Bluetooth and Personal Area networks, Broadband Wireless Access -- WiMAX Technology. Wireless Spectrum allocation, Standards.
- 1.2 Cellular System Design Fundamentals (4):** Frequency Reuse, channel assignment strategies, Handoff strategies, Interference and system capacity, trunking and grade off service, improving coverage and capacity – cell splitting, sectoring, microcells.

Module 2: Wireless Channels (7 Hours)

- 2.1 Path loss and shadowing (1):** Free space path loss, Two-Ray model, Shadowing,
- 2.2 Statistical Multipath Channel Models (4):** Time-varying channel impulse response, Narrowband fading, Wideband fading models, Delay spread and Coherence bandwidth, Doppler spread and Coherence time, Flat fading versus frequency selective fading, Slow fading versus fast fading, Discrete-time model.
- 2.3 Capacity of Wireless Channels (2):** Review of Capacity in AWGN, Capacity of flat fading channel – Ergodic capacity, Capacity with Outage, Capacity with CSI-R. (Derivations of capacity formulae are not required; Only expressions, computations and significance required.)

Module 3: Modulation techniques (7 Hours)

- 2.1 Digital Signaling for Flat fading Channels (4):** Analysis of Average Error Probability and Outage probability of BPSK in flat-fading channels.
- 2.2 Multi-carrier Modulation (3):** Data transmission using multicarrier modulation for frequency-selective fading channels. Overlapping subchannels, Mitigation of Subcarrier Fading, Discrete Implementation of multicarrier – OFDM. Cyclic prefix, Peak-to-average-power-ratio.

Module 4: Diversity, Equalization, and Multiple Access (8 Hours)

- 4.1 Diversity (3 hours):** Receiver diversity – selection combining, maximal ratio combining. Transmitter diversity – Alamouti scheme for 2x2 MIMO.
- 4.2 Equalization (3):** Equalization – Linear and non-linear equalization, Zero forcing, MMSE equalizers. LMS algorithm. Adaptive Equalization.
- 4.3 Multiuser Systems (2):** Uplink and Downlink, Multiple Access, Frequency-Division Multiple Access (FDMA), Time-Division Multiple Access (TDMA), Code-Division Multiple Access (CDMA), Orthogonal Frequency-Division Multiple Access (OFDMA).

Module 5 Radio Wave Propagation (7 Hours)

Ground wave propagation, Plane earth reflection, Space wave and surface wave, Spherical earth propagation, Tropospheric waves, Ionospheric propagation, Effects of earth's magnetic field, Critical frequency, Maximum usable Frequency, Virtual height.

Text Books

1. Andrea Goldsmith, Wireless Communications, Cambridge University Press, 2005
2. Theodore S. Rappaport, Wireless communication: Principles and Practice, 2/e, Pearson Education, 1990
3. Aditya Jagannatham, Principles of Modern Wireless Communication Systems, Mc Graw Hill, 2017.
4. Robert Collin, Antennas and Radiowave Propagation, McGraw Hill, 2016.

Reference Books

1. David Tse and Pramod Viswanath, Fundamentals of Wireless Communication, Cambridge University Press, 2005
2. Jochen Schiller, Mobile Communications, Pearson, 2008
3. Andreas F Molish , Wireless Communications, 2nd Edition , Wiley India Publications, 2013
4. W. C. Y. Lee, Mobile Cellular Telecommunication, McGraw Hill,
5. Gordon L. Stuber, Principles of Mobile Communication , Springer,2017
6. Rahim Thafazoli, Technologies for The Wireless Future , Volume 2 , Wiley and Sons , 2004
7. Edward C Jordan and Keith G Balmain, Electromagnetic Wave and Radiating System, Pearson.

Course Contents and Lecture Schedule

No	Topic	No. of Lectures
1	Introduction to wireless communication systems (8 Hours)	
1.1	Generations: 2G, 3G, 4G, 5G.	2
1.2	Wireless LAN, Bluetooth and Personal Area networks, Broadband Wireless Access -- WiMAX Technology.	1
1.3	Wireless Spectrum allocation, Standards	1
1.4	Cellular concept, Frequency Reuse, channel assignment strategies,	2

	Handoff strategies	
1.5	Interference and system capacity, trunking and grade off service.	1
1.6	improving coverage and capacity – cell splitting, sectoring, microcells.	1
2	Wireless Channels (7 Hours)	
2.1	Free space path loss, Two-Ray model, Shadowing	1
2.3	Time-varying channel impulse response, Narrowband fading	2
2.4	Wideband fading models – Delay spread and Coherence bandwidth, Doppler spread and Coherence time	1
2.5	Flat fading versus frequency selective fading, Slow fading versus fast fading, Discrete-time model.	1
2.6	Review of Capacity in AWGN, Capacity of flat fading channel – Ergodic capacity, Capacity with Outage, Capacity with CSI-R.	2
3	Modulation Techniques (7 Hours)	
3.1	Average Probability of error and outage probability	1
3.2	Performance evaluation of BPSK in flat fading channels	2
3.4	Multi carrier modulation in frequency-selective channel	1
3.5	OFDM – DFT/IDFT, Cyclic Prefix	2
3.6	PAPR	1
4	Diversity, Equalization and Multiple Access (8 Hours)	
4.1	Receiver Diversity – Selection combining, Maximal ratio combining	2
4.2	Transmit Diversity – Alamouti for 2x2 MIMO	1
4.3	Equalization – linear and nonlinear, ZF and MMSE, LMS, Adaptive	3
4.4	Multiple access – FDMA, TDMA, CDMA, OFDMA	2
5	Radio Wave Propagation (7 Hours)	
5.1	Ground wave propagation, Plane earth reflection, Space wave and surface wave	2
5.2	Spherical earth propagation, Tropospheric waves, Ionospheric propagation	2
5.3	Effects of earth's magnetic field, Critical frequency, Maximum usable Frequency, Virtual height.	3
	Total Hours	37

Simulation Assignments:

1. Simulate flat fading and frequency-selective fading wireless channel models using Python/MATLAB
2. Evaluate BPSK, QPSK, QAM in wireless fading channels using Python/MATLAB.
3. Evaluate zero-forcing and MMSE equalization techniques using Python/MATLAB.
4. Simulation of standard path loss models using Python/MATLAB.
5. Simulation of Alamouti scheme using Python/MATLAB
6. Students can undertake course projects based on following topics: (a) Channel Modelling of wireless channels (b) Comparison of modulation schemes for wireless system (c) Multi carrier modulation schemes (d) Comparison of equalization techniques (e) Implementation of MIMO schemes.

Model Question paper

APJ ABDUL KALAM TECHNOLOGICAL UNIVERSITY
EIGHTH SEMESTER B. TECH. DEGREE EXAMINATION

Course Code: ECT402

Course Name: WIRELESS COMMUNICATION

Max. Marks: 100

Duration: 3 Hours

PART A

(Answer ALL Questions. Each Question Carries 3 Marks.)

1. Give important features of 5G system.
2. Discuss different handoff strategies.
3. Explain the notion of delay spread and coherence bandwidth.
4. Give the expression for capacity of flat fading AWGN channel with CSIR. Describe how it is obtained assuming AWGN capacity.
5. Define outage probability.
6. What is the purpose of using cyclic prefix in an OFDM system?
7. Consider a channel with impulse response $h(t) = \exp(-t/T) u(t)$. Find tap coefficients of a two-tap zero-forcing equalizer for this channel.
8. Why do we say that maximal ratio combining achieves full diversity?
9. Distinguish between critical frequency and maximum usable frequency.
10. Define virtual height in antennas.

[10 X 3= 30]

PART – B

(Answer one question from each module; each question carries 14 marks)

Module I

11. (a) How are co-channel signal-to-interference ratio, cluster size and system capacity are related to one another in a cellular system ? Explain with necessary equations. [07 Marks]
 (b) Explain the architecture of wireless LAN (WLAN). [07 Marks]

OR

12. (a) List three differences between 2G and 3G systems. [03 Marks]
 (b) A total of 33MHz of bandwidth is allocated to an FDD cellular system which uses two 25kHz simplex channels to provide full-duplex voice & control channels. Compute the number of channels available per cell if the system uses 7-cell reuse. [03 Marks]
 (c) What is cell splitting? How does it improve system performance? [08 Marks]

Module II

13. (a) Explain the effect of multipath propagation using 2-ray model. [07 Marks]
 (b) Assuming narrow band fading model, derive statistical characterization of in-phase and quadrature components of a received signal when an unmodulated carrier is transmitted. [07 Marks]

OR

14. (a) Derive time-varying impulse response of multipath wireless channel. [07 Marks]
 (b) Consider a flat-fading channel with iid channel gains $g[i]$ which can take on values $g_1=0.05$ with probability $p_1=0.1$, $g_2=0.5$ with probability $p_2=0.5$, and $g_3=1$ with probability $p_3=0.4$. The transmit power is 10mW, noise spectral density $N_0 = 10^{-9}$ W/Hz, and channel bandwidth is 30kHz. Assume instantaneous CSI-R, but transmitter does not have CSI. Compute the capacity of the channel. [07 Marks]

Module III

15. (a) Derive expression for average probability of error in BPSK under Rayleigh flat-fading when symbol duration is roughly equal to channel coherence time. [07 Marks]
 (b) What is Peak-to-Average Power-Ratio (PAPR) in OFDM system? How can it be reduced ? [07 Marks]

OR

16. (a) Determine the average SNR per bit of BPSK modulation in Rayleigh slow-fading channel such that 95% of the times, average probability of bit error is less than 10^{-4} . [05 Marks]
 (b) Explain multi-carrier modulation in OFDM. [09 Marks]

Module IV

17. (a) Explain Least-Mean-Square algorithm for equalization. [09 Marks]
(b) Compute the average probability of bit error of BPSK under maximal-ratio-combining two-branch diversity with iid Rayleigh fading. Average SNR on each branch is 10dB. [05 Marks]

OR

18. (a) Describe Alamouti scheme for 2x2 MIMO. [07 Marks]
(b) Describe how multiple-access works on uplink and downlink in CDMA. [07 Marks]

Module V

19. (a) Derive an expression for the LOS distance in km when the antenna heights above ground are h_t and h_r respectively for the transmitter and receiver antennas. [07 Marks]
(b) A receiving antenna is located at 80km from the transmitting antenna. The height of the transmitting antenna is 100m. What is the required height of the receiving antenna? [07 Marks]

OR

20. (a) An HF radio communication is to be established between two points on the earth's surface. The points are at a distance of 2600km. The height of the ionosphere layer is 200km and critical frequency is 4MHz. Find maximum usable frequency. [07 Marks]
(b) Derive expression for critical frequency, maximum usable frequency and skip distance (assuming flat earth's surface) for sky wave propagation. [07 Marks]

Estd.



2014

ECT404	COMPREHENSIVE COURSE VIVA	CATEGORY	L	T	P	CREDIT
		PCC	1	0	0	1

Preamble: The objective of this Course viva is to ensure the basic knowledge of each student in the most fundamental core courses in the curriculum. The viva voce shall be conducted based on the core subjects studied from third to eighth semester. This course helps the learner to become competent in placement tests and other competitive examinations.

Guidelines

1. The course should be mapped with a faculty and classes shall be arranged for practicing questions based on the core courses listed in the curriculum.
2. The viva voce will be conducted by the same three member committee assigned for final project phase II evaluation. It comprises of Project coordinator, expert from Industry/research Institute and a senior faculty from a sister department.
3. The pass minimum for this course is 25.
4. The mark will be treated as internal and should be uploaded along with internal marks of other courses.
5. Comprehensive Viva should be conducted along with final project evaluation by the three member committee.

Mark Distribution

Total marks: 50, only CIE, minimum required to pass : 25 Marks



ECD416	PROJECT PHASE II	CATEGORY	L	T	P	CREDIT
		PWS	0	0	12	4

Preamble: The course ‘Project Work’ is mainly intended to evoke the innovation and invention skills in a student. The course will provide an opportunity to synthesize and apply the knowledge and analytical skills learned, to be developed as a prototype or simulation. The project extends to 2 semesters and will be evaluated in the 7th and 8th semester separately, based on the achieved objectives. One third of the project credits shall be completed in 7th semester and two third in 8th semester. It is recommended that the projects may be finalized in the thrust areas of the respective engineering stream or as interdisciplinary projects. Importance should be given to address societal problems and developing indigenous technologies.

Course Objectives

- To apply engineering knowledge in practical problem solving.
- To foster innovation in design of products, processes or systems.
- To develop creative thinking in finding viable solutions to engineering problems.

Course Outcomes [COs]: After successful completion of the course, the students will be able to:

CO1	Model and solve real world problems by applying knowledge across domains (Cognitive knowledge level: Apply).
CO2	Develop products, processes or technologies for sustainable and socially relevant applications (Cognitive knowledge level: Apply).
CO3	Function effectively as an individual and as a leader in diverse teams and to comprehend and execute designated tasks (Cognitive knowledge level: Apply).
CO4	Plan and execute tasks utilizing available resources within timelines, following ethical and professional norms (Cognitive knowledge level: Apply).
CO5	Identify technology/research gaps and propose innovative/creative solutions (Cognitive knowledge level: Analyze).
CO6	Organize and communicate technical and scientific findings effectively in written and oral forms (Cognitive knowledge level: Apply).

Mapping of course outcomes with program outcomes

	PO1	PO2	PO3	PO4	PO5	PO6	PO7	PO8	PO9	PO10	PO11	PO12
CO1	2	2	2	1	2	2	2	1	1	1	1	2
CO2	2	2	2		1	3	3	1	1		1	1
CO3									3	2	2	1
CO4					2			3	2	2	3	2
CO5	2	3	3	1	2							1
CO6					2			2	2	3	1	1

Abstract POs defined by National Board of Accreditation			
PO #	Broad PO	PO#	Broad PO
PO1	Engineering Knowledge	PO7	Environment and Sustainability
PO2	Problem Analysis	PO8	Ethics
PO3	Design/Development of solutions	PO9	Individual and team work
PO4	Conduct investigations of complex problems	PO0	Communication
PO5	Modern tool usage	PO11	Project Management and Finance
PO6	The Engineer and Society	PO12	Lifelong learning

PROJECT PHASE II

Phase 2 Targets

- In depth study of the topic assigned in the light of the report prepared under Phase - I;
- Review and finalization of the approach to the problem relating to the assigned topic.
- Preparing a detailed action plan for conducting the investigation, including teamwork.
- Detailed Analysis/ Modeling / Simulation/ Design/ Problem Solving/Experiment as needed.
- Final development of product/ process, testing, results, conclusions and future directions.
- Preparing a paper for Conference Presentation/ Publication in Journals, if possible.
- Presenting projects in Project Expos conducted by the University at the cluster level and/ or state level as well as others conducted in India and abroad.
- Filing Intellectual Property Rights (IPR) if applicable.
- Preparing a report in the standard format for being evaluated by the Department Assessment Board.
- Final project presentation and viva voce by the assessment board including the external expert.

Evaluation Guidelines & Rubrics

Total: 150 marks (Minimum required to pass: 75 marks).

- Project progress evaluation by guide: 30 Marks.
- Two interim evaluations by the Evaluation Committee: 50 Marks (25 marks for each evaluation).
- Final evaluation by the Final Evaluation committee: 40 Marks
- Quality of the report evaluated by the evaluation committee: 30 Marks

(The evaluation committee comprises HoD or a senior faculty member, Project coordinator and project supervisor. The final evaluation committee comprises of Project coordinator, expert from Industry/research/academic Institute and a senior faculty from a sister department).

Evaluation by the Guide

The guide/supervisor must monitor the progress being carried out by the project groups on regular basis. In case it is found that progress is unsatisfactory it should be reported to the Department Evaluation Committee for necessary action. The presence of each student in the group and their involvement in all stages of execution of the project shall be ensured by the guide. Project evaluation by the guide: 30 Marks. This mark shall be awarded to the students in his/her group by considering the following aspects:

Project Scheduling & Distribution of Work among Team members: Detailed and extensive Scheduling with timelines provided for each phase of project. Work breakdown structure well defined. (5)

Literature survey: Outstanding investigation in all aspects. (4)

Student's Diary/ Daily Log: The main purpose of writing daily diary is to cultivate the habit of documenting and to encourage the students to search for details. It develops the students' thought process and reasoning abilities. The students should record in the daily/weekly activity diary the day to day account of the observations, impressions, information gathered and suggestions given, if any. It should contain the sketches & drawings related to the observations made by the students. The daily/weekly activity diary shall be signed after every day/week by the guide. (7)

Individual Contribution: The contribution of each student at various stages. (9)

Completion of the project: The students should demonstrate the project to their respective guide. The guide shall verify the results and see that the objectives are met. (5)



EVALUATION RUBRICS for PROJECT Phase II: Interim Evaluation - 1

No.	Parameters	Marks	Poor	Fair	Very Good	Outstanding
2-a	Novelty of idea, and Implementation scope [CO5] [Group Evaluation]	5	The project is not addressing any useful requirement. The idea is evolved into a non-implementable one. The work presented so far is lacking any amount of original work by the team.	Some of the aspects of the proposed idea can be implemented. There is still lack of originality in the work done so far by the team. The project is a regularly done theme/topic without any freshness in terms of specifications, features, and/or improvements.	Good evidence of an implementable project. There is some evidence for the originality of the work done by the team . There is fresh specifications/features/improvements suggested by the team. The team is doing a design from fundamental principles, and there is some independent learning and engineering ingenuity.	The project has evolved into incorporating an outstandingly novel idea. Original work which is not yet reported anywhere else. Evidence for ingenious way of innovation which is also Implementable. Could be a patentable / publishable work.
			(0 – 1 Marks)	(2 – 3 Marks)	(4 Marks)	(5 Marks)
2-b	Effectiveness of task distribution among team members. [CO3] [Group Evaluation]	5	No task distribution of any kind. Members are still having no clue on what to do.	Task allocation done, but not effectively, some members do not have any idea of the tasks assigned. Some of the tasks were identified but not followed individually well.	Good evidence of task allocation being done, supported by project journal entries, identification of tasks through discussion etc. However, the task distribution seems to be skewed, and depends a few members heavily than others. Mostly the tasks are being followed by the individual members.	Excellent display of task identification and distribution backed by documentary evidence of team brainstorming, and project journal entries. All members are allocated tasks according to their capabilities, and as much as possible in an equal manner. The individual members are following the tasks in an excellent manner.
			(0 – 1 Marks)	(2 – 3 Marks)	(4 Marks)	(5 Marks)
2-c	Adherence to project schedule. [CO4] [Group Evaluation]	5	Little or no evidence of continued planning or scheduling of the project. The students did not stick to the plan what they were going to build nor plan on what materials / resources to use in the project. The students do not have any idea on the budget required even after the end of phase - I. No project journal kept or the journal.	There is some improvement in the primary plan prepared during phase I. There were some ideas on the materials /resources required, but not really thought out. The students have some idea on the finances required, but they have not formalized a budget plan. Schedules were not prepared. The project journal has no useful details on the project.	Good evidence of planning done and being followed up to a good extent after phase I. Materials were listed and thought out, but the plan wasn't followed completely. Schedules were prepared, but not detailed, and needs improvement. Project journal is presented but it is neither complete nor updated regularly.	Excellent evidence of enterprising and extensive project planning and follow-up since phase I. Continued use of project management/version control tool to track the project. Material procurement if applicable is progressing well. Tasks are updated and incorporated in the schedule. A well-kept project journal showed evidence for all the above, in addition to the interaction with the project guide.
			(0 - 1 Marks)	(2 - 3 Marks)	(4 Marks)	(5 Marks)

2-d	Interim Results. [CO6] [Group assessment]	5	There are no interim results to show.	The team showed some interim results, but they are not complete / consistent to the current stage, Some corrections are needed.	The interim results showed were good and mostly consistent/correct with respect to the current stage. There is room for improvement.	There were significant interim results presented which clearly shows the progress.
			(0 - 1 Marks)	(2 - 3 Marks)	(4 Marks)	(5 Marks)
2-e	Presentation [Individual assessment]	5	Very poor presentation and there is no interim results. The student has no idea about the project proposal.	Presentation is average, and the student has only a feeble idea about the team work.	Good presentation. Student has good idea about the team's project. The overall presentation quality is good.	Exceptionally good presentation. Student has excellent grasp of the project. The quality of presentation is outstanding.
			(0 - 1 Marks)	(2 - 3 Marks)	(4 Marks)	(5 Marks)
Phase-II Interim Evaluation - 1 Total Marks: 25						

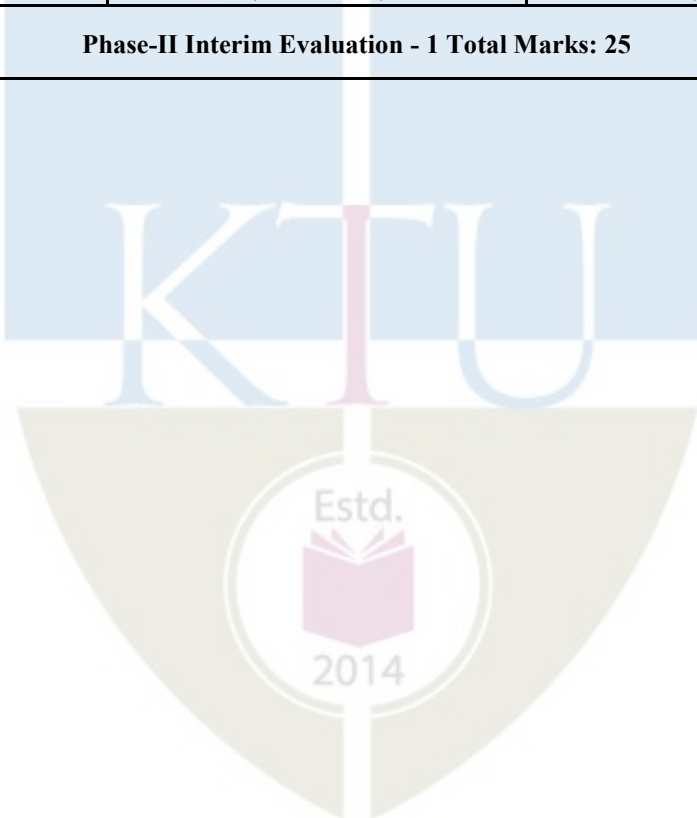

EVALUATION RUBRICS for PROJECT Phase II: Interim Evaluation – 2

No	Parameters	Marks	Poor	Fair	Very Good	Outstanding
2-f	Application of engineering knowledge [CO1] [Individual Assessment]	10	The student does not show any evidence of applying engineering knowledge on the design and the methodology adopted. The student's contribution in application of engineering knowledge in the project is poor.	The student appears to apply some basic knowledge, but not able to show the design procedure and the methodologies adopted in a comprehensive manner.	The student is able to show some evidence of application of engineering knowledge in the design and development of the project to good extent.	Excellent knowledge in design procedure and its adaptation. The student is able to apply knowledge from engineering domains to the problem and develop solutions.
			(0 – 3 Marks)	(4 – 6 Marks)	(7 - 9 Marks)	(10 Marks)
2-g	Involvement of individual members [CO3] [Individual Assessment]	5	No evidence of any Individual participation in the project work.	There is evidence for some amount of individual contribution, but is limited to some of the superficial tasks.	The individual contribution is evident. The student has good amount of involvement in core activities of the project.	Evidence available for the student acting as the core technical lead and has excellent contribution to the project.
			(0 - 1 Marks)	(2 - 3 Marks)	(4 Marks)	(5 Marks)
2-h	Results and inferences upon execution [CO5] [Group Assessment]	5	None of the expected outcomes are achieved yet. The team is unable to derive any inferences on the failures/ issues observed. Any kind of observations or studies are not made.	Only a few of the expected outcomes are achieved. A few inferences are made on the observed failures/issues. No further work suggested.	Many of the expected outcomes are achieved. Many observations and inferences are made, and attempts to identify the issues are done. Some suggestions are made for further work.	Most of the stated outcomes are met. Extensive studies are done and inferences drawn. Most of the failures are addressed and solutions suggested. Clear and valid suggestions made for further work.
			(0 - 1 Marks)	(2 - 3 Marks)	(4 Marks)	(5 Marks)
2-i	Documentation and presentation. [CO6] [Individual assessment]	5	The individual student has no idea on the presentation of his/her part. The presentation is of poor quality.	Presentation's overall quality needs to be improved.	The individual's presentation performance is satisfactory.	The individual's presentation is done professionally and with great clarity. The individual's performance is excellent.
			(0 - 1 Marks)	(2 - 3 Marks)	(4 Marks)	(5 Marks)

Phase-II Interim Evaluation - 2 Total Marks: 25

EVALUATION RUBRICS for PROJECT Phase II: Final Evaluation

No	Parameters	Marks	Poor	Fair	Very Good	Outstanding
2-j	Engineering knowledge. [CO1] [Group Assessment]	10	The team does not show any evidence of applying engineering knowledge on the design and the methodology adopted.	The team is able to show some of the design procedure and the methodologies adopted, but not in a comprehensive manner.	The team is able to show evidence of application of engineering knowledge in the design and development of the project to good extent. There is scope for improvement.	Excellent knowledge in design procedure and its adaptation. The team is able to apply knowledge from engineering domains to the problem and develop an excellent solution.
			(0 – 3 Marks)	(4 – 6 Marks)	(7 - 9 Marks)	(10 Marks)
2-k	Relevance of the project with respect to societal and/or industrial needs. [Group Assessment] [CO2]	5	The project as a whole do not have any societal / industrial relevance at all.	The project has some relevance with respect to social and/or industrial application. The team has however made not much effort to explore further and make it better.	The project is relevant to the society and/or industry. The team is mostly successful in translating the problem into an engineering specification and managed to solve much of it.	The project is exceptionally relevant to society and/or industry. The team has made outstanding contribution while solving the problem in a professional and/or ethical manner.
			(0 - 1 Marks)	(2 - 3 Marks)	(4 Marks)	(5 Marks)
2-i	Innovation / novelty / Creativity [CO5] [Group Assessment]	5	The project is not addressing any useful requirement. The idea is evolved into a non-implementable one. The work presented so far is lacking any amount of original work by the team.	Some of the aspects of the proposed idea appears to be practical. There is still lack of originality in the work done. The project is a regularly done theme/topic without any freshness in terms of specifications, features, and/or improvements.	Good evidence of an implementable project. There is some evidence for the originality of the work done by the team. There is fresh specifications/features/improvements suggested by the team. The team is doing a design from fundamental principles, and there is some independent learning and engineering ingenuity. Could be translated into a product / process if more work is done.	The project has evolved into incorporating an outstandingly novel idea. Original work which is not yet reported anywhere else. Evidence for ingenious way of innovation which is also Implementable. Could be a patentable publishable work.
			(0 - 1 Marks)	(2 - 3 Marks)	(4 Marks)	(5 Marks)
2-m	Quality of results / conclusions / solutions. [CO1] [Group Assessment]	10	None of the expected outcomes are achieved. The team is unable to derive any inferences on the failures/issues observed. Any kind of observations or studies is not made.	Only a few of the expected outcomes are achieved. A few inferences are made on the observed failures/issues. No further work suggested.	Many of the expected outcomes are achieved. Many observations and inferences are made, and attempts to identify the issues are done. Some suggestions are made for further work.	Most of the stated outcomes are met. Extensive studies are done and inferences drawn. Most of the failures are addressed and solutions suggested. Clear and valid suggestions made for further work.
			(0 – 3 Marks)	(4 – 6 Marks)	(7 - 9 Marks)	(10 Marks)

2-n	Presentation - Part I Preparation of slides. [CO6] [Group Assessment].	5	The presentation slides are shallow and in a clumsy format. It does not follow proper organization.	Presentation slides follow professional style formats to some extent. However, its organization is not very good. Language needs to be improved. All references are not cited properly, or acknowledged. Presentation slides needs to be more professional.	Presentation slides follow a good style format and there are only a few issues. Organization of the slides is good. Most of references are cited properly. The flow is good and team presentation is neatly organized. Some of the results are not clearly shown. There is room for improvement.	The presentation slides are exceptionally good. Neatly organized. All references cited properly. Diagrams/Figures, Tables and equations are properly numbered, and listed. Results/ inferences clearly highlighted and readable.
			(0 - 1 Marks)	(2 - 3 Marks)	(4 Marks)	(5 Marks)
	Presentation - Part II: Individual Communication [CO6] [Individual Assessment].	5	The student is not communicating properly. Poor response to questions.	The student is able to explain some of the content. The student requires a lot of prompts to get to the idea. There are language issues.	Good presentation/ communication by the student. The student is able to explain most of the content very well. There are however, a few areas where the student shows lack of preparation. Language is better.	Clear and concise communication exhibited by the student. The presentation is outstanding. Very confident and tackles all the questions without hesitation. Exceptional traits of communicator.
			(0 - 1 Marks)	(2 - 3 Marks)	(4 Marks)	(5 Marks)
Phase-II Final Evaluation, Marks: 40						



EVALUATION RUBRICS for PROJECT Phase II: Report Evaluation

Sl. No.	Parameters	Marks	Poor	Fair	Very Good	Outstanding
2-o	Report [CO6]	30	The prepared report is shallow and not as per standard format. It does not follow proper organization. Contains mostly unacknowledged content. Lack of effort in preparation is evident. References are not cited. Unprofessional and inconsistent formatting.	Project report follows the standard format to some extent. However, its organization is not very good. Language needs to be improved. All references are not cited properly in the report. There is lack of formatting consistency.	Project report shows evidence of systematic documentation. Report is mostly following the standard style format and there are only a few issues. Organization of the report is good. Mostly consistently formatted. Most of references/sources are cited, acknowledged properly.	The report is exceptionally good. Neatly organized. All references cited properly. Diagrams/Figures, Tables and equations are properly numbered, and listed and clearly shown. Language is excellent and follows professional styles. Consistent formatting and exceptional readability.
			(0 - 11 Marks)	(12 - 18 Marks)	(19 - 28 Marks)	(29 - 30 Marks)
Phase - II Project Report Marks: 30						

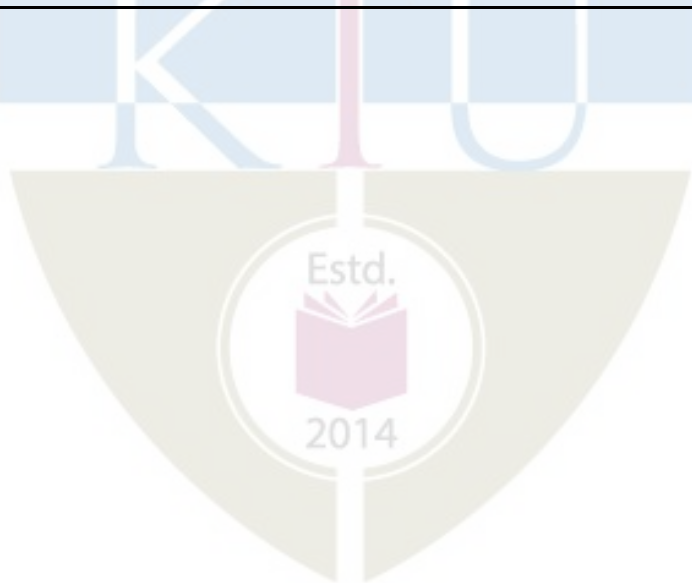

APJ ABDUL KALAM
TECHNOLOGICAL
UNIVERSITY

SEMESTER VIII

PROGRAM ELECTIVE III



ECT414	BIOMEDICAL ENGINEERING	CATEGORY	L	T	P	CREDIT
		PEC	2	1	0	3

Preamble: This course will introduce aspects of biomedical engineering as applied to biological systems described using engineering principles and the use of modern diagnostic and therapeutic equipment.

Prerequisite: NIL

Course Outcomes: After the completion of the course the student will be able to

CO1	Understand basic bioelectric potentials and its implications in diagnostics
CO2	Understand the principles used for diagnosis of abnormalities in the cardiovascular system
CO3	Explain the techniques used for diagnosis and therapy in the neuromuscular system
CO4	Understand the principle and working of different types of bio medical equipment/device
CO5	Classify various diagnostic medical imaging techniques.

	PO1	PO2	PO3	PO4	PO5	PO6	PO7	PO8	PO9	PO10	PO11	PO12
CO1	3	2										
CO2	3	2										
CO3	3	3										
CO4	3	3										
CO5	3	3										

Assessment Pattern

Bloom's Category	Continuous Assessment Tests		End semester examination
	I	II	
Remember	10	10	10
Understand	20	20	20
Apply	20	20	70
Analyze			
Evaluate			
Create			

Mark distribution

Total marks	CIE	ESE	ESE Duration
150	50	100	3 hours

Continuous Internal Evaluation Pattern:

Attendance	: 10 marks
Continuous Assessment Test (2 numbers)	: 25 marks
Assignment/Quiz/Course project	: 15 marks

End Semester Examination Pattern: There will be two parts; Part A and Part B. Part A contain 10 questions with 2 questions from each module, having 3 marks for each question. Students should answer all questions. Part B contains 2 questions from each module of which student should answer any one. Each question can have maximum 2 sub-divisions and carry 14 marks.

Course Level Assessment Questions

Course Outcome 1 (CO1): Understand basic bioelectric potentials and their implications in diagnostics

1. Explain the different types of bio electric potential with diagrams?
2. How does depolarisation and repolarisation occur in a cell?
3. Explain different types of bio-potential electrodes?

Course Outcome 2 (CO2): Explain the principles used for diagnosis of abnormalities in the cardiovascular system

1. Explain ECG machine with a block diagram
2. A patient was subjected to non-invasive method of blood pressure measurement. Which is the method used? What is the principle behind the method and how is it done?

Course Outcome 3 (CO3): Explain the techniques used for diagnosis and therapy in the neuromuscular system

1. Explain with a diagram the 10-20 system of electrode placement to perform EEG analysis.
2. Explain instrumentation system for acquiring EMG?
3. Explain how functional activity can be elicited from the paralyzed limb of a spinal cord injured patient using electrical stimulation.

Course Outcome 4 (CO4): Understand the principle and working of different types of bio medical equipment/device

1. Explain ventilator parameters?
2. What is a cardiac defibrillator? With a neat diagram explain DC defibrillator.
3. With a neat block diagram explain single channel ECG telemetry transmitter

Course Outcome 5 (CO5): Understand various diagnostic medical imaging techniques

1. Explain the principle of basic pulse echo system with necessary diagrams.
2. Compare NMR imaging and CT imaging.

Syllabus**Module 1**

Introduction to bio-medical engineering, overview of anatomy and physiological systems of the body. Sources of bio-electric potential: Resting and action potential, propagation of action potentials. Bioelectric potentials examples (ECG, EEG, EMG, ERG, EOG, EGG concept only.) Electrode theory: Nernst relation, Electrode skin interface, Bio potential electrodes: Microelectrodes, skin surface electrodes, needle electrodes
Instrumentation for clinical laboratory: Bio potential amplifiers-instrumentation amplifiers, carrier amplifiers, isolation amplifiers, chopper amplifiers

Module 2

Heart and cardiovascular system (brief discussion), electro conduction system of the heart. Electrocardiography, ECG machine block diagram, ECG lead configurations, ECG recording system, Einthoven triangle, analysis of ECG signals.
Measurement of blood pressure: Direct, indirect and relative methods of blood pressure measurement, auscultatory method, oscillometric and ultrasonic noninvasive pressure measurements.
Measurement of blood flow: Electromagnetic blood flowmeters and ultrasonic blood flow meters

Module 3

The human nervous system. Neuron, action potential of brain, brain waves, types of electrodes, placement of electrodes, evoked potential, EEG recording, analysis of EEG.
Electrical activity of muscles- EMG. Signal Acquisition and analysis. Applications of EMG - myoelectric control system. Electrical stimulation of the muscle and nerve, Functional Electrical Stimulation- Principle and applications.
Physiology of respiratory system (overview), Respiratory parameters, spirometer, body plethysmographs, gas exchange and distribution.

Module 4

Instruments for clinical laboratory: Oxymeters, pH meter, blood cell counter, flame photometer, spectrophotometer

Therapeutic Equipments: Principle, block schematic diagram, working and applications of : pacemakers, cardiac defibrillators, heart–lung machine, dialyzers, surgical diathermy equipment, ventilators

Biomedical Telemetry system: Components of biotelemetry system, application of telemetry in medicine, single channel telemetry system for ECG and temperature measurement.

Module 5

Medical Imaging systems (Basic Principle only): X-ray imaging - Properties and production of X-rays, X-ray machine, applications of X-rays in medicine.

Computed Tomography: Principle, image reconstruction, scanning system and applications

Ultrasonic imaging systems: Basic pulse echo system, propagation of ultrasonic through tissues and reflections, display types, A-Scan, B-Scan, M-Scan, applications, real-time ultrasonic imaging systems and probes.

Magnetic Resonance Imaging – Basic NMR components, Biological effects and advantages of NMR imaging

Patient Safety: Electric shock hazards, leakage current, safety codes for electro medical equipments

Text Books

1. R. S. Khandpur, Handbook of Biomedical Instrumentation, Tata Mc Graw Hill
2. Leslie Cromwell, Fred J. Weibell, Erich A. Pfeiffer, Biomedical Instrumentation and Measurements, PHI, 2nd Edition, 2004

References:

1. John G Webster, “Medical Instrumentation application and design”, John Wiley 3rde/d
2. J. J. Carr, “Introduction to Biomedical Equipment Technology”, Pearson Education 4th e/d.
3. Richard Aston, “Principle of Biomedical Instrumentation and Measurement”. Merrill Education/Prentice Hall.
4. Barbara Christie, Introduction to Biomedical Instrumentation, Cambridge University Press, 2008

Course Contents and Lecture Schedule

MODULE NO	TOPIC	NO. OF LECTURES
I	Introduction to bio-medical instrumentation system, overview of anatomy and physiological systems of the body.	2
	Sources of bio-electric potential: Resting and action potential, propagation of action potentials, Bioelectric potentials examples (ECG, EEG, EMG, ERG, EOG, EGG concept only.)	2
	Electrode theory: Nernst relation, Electrode skin interface,	1
	Bio potential electrodes: Microelectrodes, skin surface electrodes, needle electrodes	1
	Instrumentation for clinical laboratory: Bio potential amplifiers-instrumentation amplifiers, carrier amplifiers, isolation amplifiers, chopper amplifiers	2
II	Heart and cardiovascular system (brief discussion), electro conduction system of the heart. Electrocardiography	1
	ECG machine block diagram, ECG lead configurations, ECG recording system, Einthoven triangle, analysis of ECG signals.	2
	Measurement of blood pressure: Direct, indirect and relative methods of blood pressure measurement, auscultatory method, oscillometric and ultrasonic noninvasive pressure measurements.	2
	Measurement of blood flow: Electromagnetic blood flow meters and ultrasonic blood flow meters	1
III	The human nervous system. Neuron, action potential of brain, brain waves, types of electrodes, placement of electrodes, evoked potential, EEG recording, analysis of EEG.	2
	Electrical activity of muscles- EMG. Signal Acquisition and analysis. Applications of EMG - myoelectric control system.	2
	Electrical stimulation of the muscle and nerve, Functional Electrical Stimulation- Principle and applications.	1
	Physiology of respiratory system (overview), Respiratory parameters, spirometer, body plethysmographs, gas exchange and distribution.	2
IV	Instruments for clinical laboratory: Oxymeters, pH meter, blood cell counter, flame photometer, spectrophotometer	2
	Therapeutic Equipments: Principle, block schematic diagram, working and applications of : pacemakers, cardiac defibrillators	2
	heart-lung machine, dialyzers, surgical diathermy equipment, ventilators	2

	Biomedical Telemetry system: Components of biotelemetry system, application of telemetry in medicine	1
V	Medical Imaging systems (Basic Principle only): X-ray imaging - Properties and production of X-rays, X-ray machine, applications of X-rays in medicine.	2
	Computed Tomography: Principle, image reconstruction, scanning system and applications	1
	Ultrasonic imaging systems: Basic pulse echo system, propagation of ultrasonic through tissues and reflections, display types, A-Scan, B-Scan, M-Scan, applications, real-time ultrasonic imaging systems and probes.	2
	Magnetic Resonance Imaging – Basic NMR components, Biological effects and advantages of NMR imaging	1
	Patient Safety: Electric shock hazards, leakage current, safety codes for electro medical equipments	1

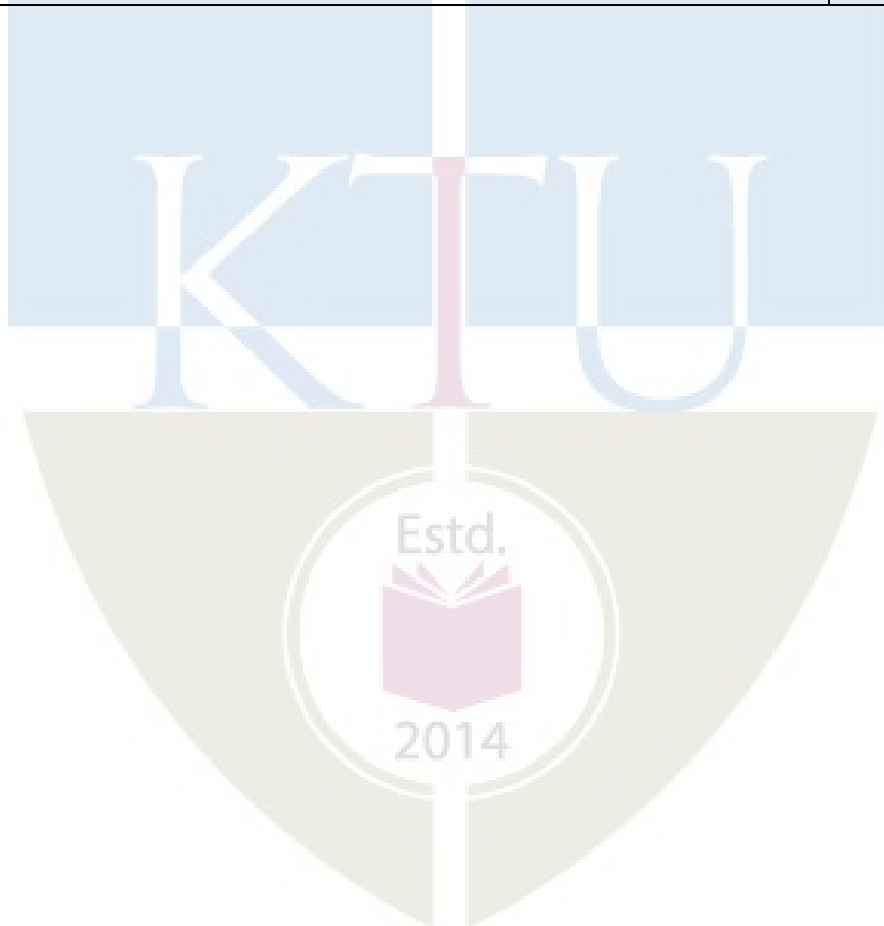

Model Question Paper

APJ ABDUL KALAM TECHNOLOGICAL UNIVERSITY
EIGHTH SEMESTER B.TECH DEGREE EXAMINATION
(Electronics & Communication Engineering)
BIOMEDICAL ENGINEERING

Max Marks : 100**Duration : 3 Hours****PART A**

(Answer all questions. Each question carries 3 marks)

- | | | |
|----|---|---|
| 1 | What is a microelectrode? List any two | 3 |
| 2 | List three typical features of a biopotential amplifier | 3 |
| 3 | Draw and explain the Einthoven triangle | 3 |
| 4 | List the various blood pressure measurement techniques | 3 |
| 5 | Explain action potential and Resting Potential of brain? | 3 |
| 6 | What is meant by nerve conduction velocity. What is its significance? | 3 |
| 7 | List three ventilator parameters and explain any one. | 3 |
| 8 | What is ventricular defibrillation. | 3 |
| 9 | What are the electric shock hazards? | 3 |
| 10 | Compare NMR imaging and CT imaging. | 3 |

PART B

(Answer one full question from each module)

MODULE 1

- | | | |
|------|--|---|
| 11a) | Explain about electrode-electrolyte interface and the electrical activity associated with one contraction in a muscle. | 8 |
| b) | Explain isolation amplifier with a neat diagram? | 6 |

OR

- | | | |
|------|---|---|
| 12a) | How does depolarisation and repolarisation occur in a cell? | 7 |
|------|---|---|

- b) Explain chopper amplifier with a neat diagram? State applications 7

MODULE 2

- 13a) With necessary illustration, explain any two basic ECG lead configurations. 7

- b) Explain ultrasonic blood flow meter with neat diagram? What are the advantages over other flow meters? 7

OR

- 14a) Explain electro conduction system of the heart with illustration 7

- b) Compare direct and indirect blood pressure measurement. What is Korotkoff sound in blood pressure measurement? 7

MODULE 3

- 15a) With necessary block schematic explain the principle of operation of a myoelectric controlled prosthetic device. 7

- b) With necessary illustration, explain the placement of electrodes for recording EEG signal. 7

OR

- 16a) Explain different respiratory parameters. Explain the working of a spirometer. 7

- b) List six applications of Functional electrical stimulation and explain one application in detail. 7

MODULE 4

- 17a) What is a pacemaker? What is its significance? Explain the working with illustration of an atrio-synchronous pacemaker. 7

- b) What is diathermy? With a neat block schematic diagram, explain the working and applications of surgical diathermy equipments. 7

OR

- 18a) What is dialysis? Explain any one type of dialyzer with necessary illustration 7

- b) With the help of neat block diagram, explain the components of biotelemetry system 7

MODULE 5

- 19a) With a neat block diagram, explain the technique of producing CT images. 7
- b) Explain the principle and any one application of M-mode display in ultrasound systems. 7
- OR
- 20a) Explain the components of an NMR imaging system with neat block diagram 8
- b) Explain how electric shock is hazardous to human body. What changes it will bring in the body, when the current increases. 6

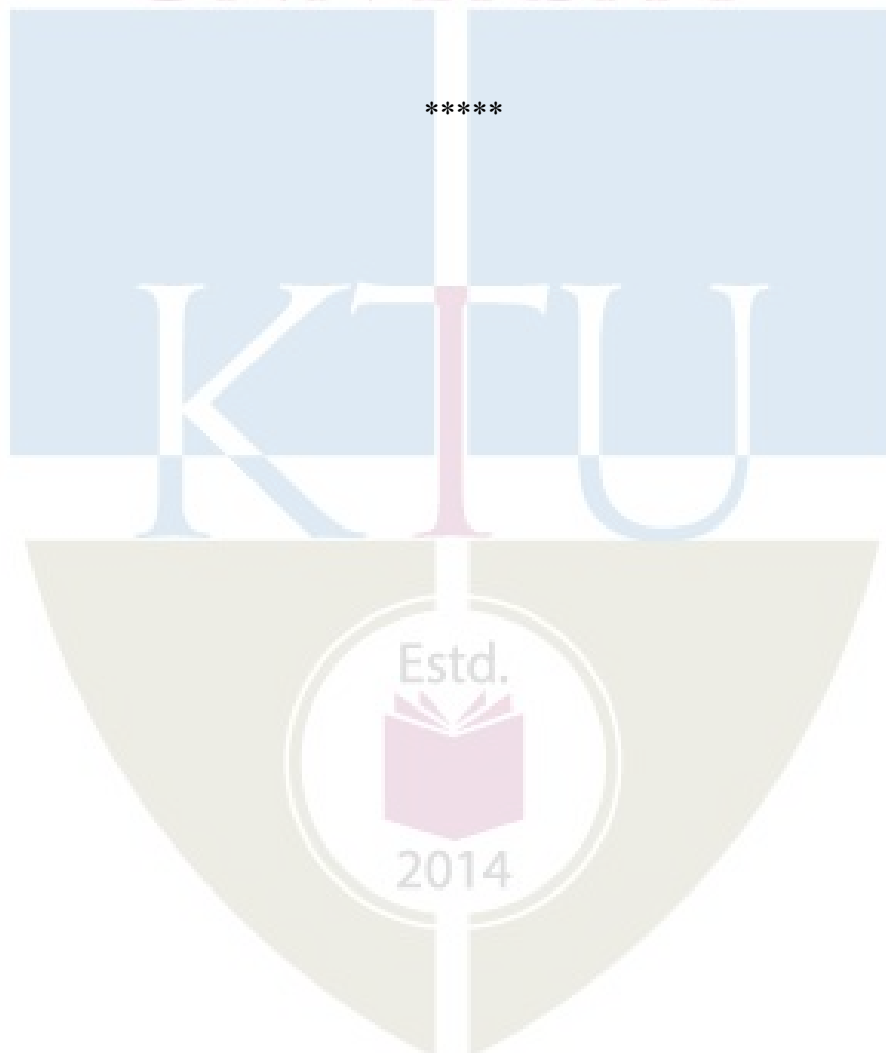

ECT424	SATELLITE COMMUNICATION	CATEGORY	L	T	P	CREDIT
		PEC	2	1	0	3

Preamble: This course aims to impart the basic knowledge of satellite communication and its applications.

Prerequisite: ECT 305 Analog & Digital communication

Course Outcomes: After the completion of the course the student will be able to

CO1	Define satellite communications & possible satellite orbits.
CO2	Describe satellite communication subsystems & launching mechanisms of satellites.
CO3	Calculate link budgets. Provide an in-depth treatment of satellite communication systems operation and planning
CO4	Analyze the various methods of satellite access.
CO5	Discuss various applications of satellite communications

Mapping of course outcomes with program outcomes

	PO1	PO2	PO3	PO4	PO5	PO6	PO7	PO8	PO9	PO10	PO11	PO12
CO1	3	3										
CO2	3	3										
CO3	3	3	3									
CO4	3	3			2							
CO5	3	3										

Assessment Pattern

Bloom's Category	Continuous Assessment Tests		End Semester Examination
	1	2	
Remember	15	15	20
Understand	15	15	20
Apply	10	10	30
Analyse	10	10	30
Evaluate			
Create			

Mark distribution

Total Marks	CIE	ESE	ESE Duration
150	50	100	3 hours

Continuous Internal Evaluation Pattern:

Attendance	: 10 marks
Continuous Assessment Test (2 numbers)	: 25 marks
Course Seminar & Assignment	: 15 marks

It is mandatory that a course seminar shall be undertaken by each student for this subject. The course seminar of 5 to 10 minute durations shall be presented by taking any topic related with satellite communication approved by the faculty. Students shall be awarded 5 marks for presentation of topic and a brief report. The report has to be submitted for academic auditing. In addition two assignments may be given for 5 marks each which can be a class or home assignment.

End Semester Examination Pattern: There will be two parts; Part A and Part B. Part A contain 10 questions with 2 questions from each module, having 3 marks for each question. Students should answer all questions. Part B contains 2 questions from each module of which student should answer any one. Each question can have maximum of 2 sub-divisions and carry 14 marks.

Course Level Assessment Questions

Course Outcome 1 (CO1): Define satellite communications & possible satellite orbits.

1. Explain the different types of satellite orbits?
2. Describe various orbital elements
3. Describe the effect of orbits on satellite performance?

Course Outcome 2 (CO2): Describe satellite communication subsystems & launching mechanisms of satellites.

1. Describe the major subsystems of a communication satellite.
2. Describe the significance of antenna subsystem why uplink and downlink frequency different in satellite communication are different.

Course Outcome 3 (CO3): Calculate link budgets. Provide an in-depth treatment of satellite communication systems operation and planning

1. Calculation of total link loss for various sky condition
2. Calculation of Effective Isotropic Radiated Power required for various Sky Conditions.

Course Outcome 4 (CO4): Analyze the various methods of satellite access

1. Describe various multiple Access Technique.
2. Compare the uplink power requirement for FDMA and TDMA

Course Outcome 5 (CO5): Discuss various applications of satellite communications

1. Explain the Basic Principle of navigation Satellite.
2. Explain Satellite Radio Broadcasting.

SYLLABUS**Module 1: Satellite Orbits:**

Introduction to Satellite Communication, Historical background, Basic concepts of Satellite Communications, Kepler's laws of planetary motion, types of satellite orbits, orbit determination. Definitions of terms for Earth-Orbiting Satellites, Orbital Elements, Apogee and Perigee Heights, satellite stabilization, orbital effects on satellites performance. Antenna Look Angles, The Polar Mount Antenna, Limits of Visibility, launch systems for geostationary satellites.

Module 2: Satellite System:

The Space Segment

Introduction, The Power Supply, Attitude & Orbit Control, Satellite stabilization, Station Keeping, Thermal Control, TT&C Subsystem, Transponders, Antenna Subsystem

The Earth Segment

Types of earth station, architecture & design considerations. Transmit-Receive Earth Station,

Wideband receiver, the input demultiplexer, the power amplifier, Satellite tracking.

Module 3: The Satellite Link design :

Introduction, Transmission Theory, System Noise Temperature and G/T Ratio, Design of Downlinks

Ku-Band GEO Satellite Systems, Uplink Design, Design for Specified CNR: Combining CNR and C/I Values in Satellite Links, System Design for Specific Performance. Regional & global satellite systems INSAT, INTELSAT & INMARSAT.

Module 4: Modulation & Multiple Access

Introduction, Digital Modulation techniques preferred in satellites, Multiple Access, Frequency Division Multiple Access (FDMA),

Time Division Multiple Access (TDMA), Transmitter Power in TDMA Networks, Demand Assignment Multiple Access (DAMA), Random Access (RA), Packet Radio Systems and Protocols, Code Division Multiple Access (CDMA)

Module 5: Satellite Application:

Introduction, Frequency bands, Comparison between Satellite & terrestrial networks, Satellite Telephony, Satellite Television, DTH, Satellite Radio broadcasting, Remote Sensing Satellite; Classification, orbits, payloads, Weather Forecasting Satellites: Orbits, payloads.

Navigation Satellite: Basic principles of satellite navigation, GPS Position Location Principle functional segments of GPS, Indian Contribution to positioning systems. NGSO satellite systems.

Text Books

1. Dennis Roddy, Satellite Communications, 4th Edition, McGraw- Hill International edition, 2006
2. Timothy Pratt, Jeremy E, Allnutt, Satellite Communications, Wiley, 3rd Edition, October 2019

Reference Books

1. Gerard Maral, Michel Bousquet, Zhili Sun, Satellite Communications Systems: Systems, Techniques and Technology, Wiley, 6th edition, April 2020
2. Anil K. Maini, Varsha Agrawal, Satellite Communications, Wiley India Pvt. Ltd.,

2015

3. TRIT. HA, Digital Satellite Communications, McGraw-Hill, second edition

Course Content & Lecture Schedule

Sr. No.	Content	Total Hrs
Module 1	Satellite Orbits	
	Introduction to Satellite Communication, Historical background, Basic concepts of Satellite Communication	1
	Kepler's laws of planetary motion, types of satellite orbits, orbit determination	2
	Definitions of terms for Earth-Orbiting Satellites, Orbital Elements, Apogee and Perigee Heights,	1
	Satellite stabilization, orbital effects on satellites performance.	1
	Antenna Look Angles, The Polar Mount Antenna, Limits of Visibility	1
	Launch systems for geostationary satellites.	1
Module 2	Satellite System	
	The Space Segment Introduction, The Power Supply, Attitude & Orbit Control, Satellite stabilization, Station Keeping, Thermal Control,	2
	TT&C Subsystem, Transponders,	1
	Antenna Subsystem, Antenna types & design equation (derivation not required)	1
	The Earth Segment Types of earth station, architecture & design considerations Transmit-Receive Earth Station ,	2
	Wide band receiver, The input demultiplexer, The power amplifier, Satellite tracking.	1
Module 3	The Satellite Link design	
	Introduction, Transmission Theory , System Noise Temperature and G/T Ratio , Design of Downlinks Ku-Band GEO Satellite Systems	2
	Uplink Design , Design for Specified CNR: Combining CNR and C/I Values in Satellite Links , System Design for Specific Performance	2
	Regional & global satellite systems INSAT, INTELSAT & INMARSAT.	2
	Modulation & Multiple Access	
	Introduction, Digital Modulation techniques preferred in satellite communication.	2

Module4	Multiple Access ,Frequency Division Multiple Access (FDMA) ,Time Division Multiple Access (TDMA), Transmitter Power in TDMA Networks, Demand Assignment Multiple Access (DAMA),	2
	Random Access (RA) , Packet Radio Systems and Protocols, Code Division Multiple Access (CDMA)	3
Module 5	Satellite Application:	
	Introduction, Frequency bands, , Comparison between Satellite & terrestrial networks,	1
	Satellite Telephony, Satellite Television, DTH, Satellite Radio broadcasting,	2
	Remote Sensing Satellite; Classification, orbits, payloads, Weather Forecasting Satellites: Orbits, payloads.	2
	Navigation Satellite: Basic principles of satellite navigation, GPS Position Location Principle functional segments of GPS. Indian Contribution to positioning systems, NGSO satellite systems.	3
Total		35



Model Question Paper

A P J ABDUL KALAM TECHNOLOGICAL UNIVERSITY
Eighth Semester B Tech Degree Examination Branch: Electronics and Communication
Course: ECT424 SATELLITE COMMUNICATION

PART A

(Answer All Questions. Each question carries 3 marks)

1. How do geostationary and geosynchronous orbit differ?
2. What are the limits of visibility of a satellite?
3. How thermal control achieved in space craft? Why is it necessary?
4. What is the need of tracking a spacecraft & how is it practiced?
5. Briefly describe the causes of interference and noise in a satellite link?
6. Why uplink and downlink frequency different in satellite communication?
7. State the advantages of demand assignment over preassigned access techniques?
8. Why synchronization is a must for TDMA?
9. Compare satellite & terrestrial networks?
10. State the orbital requirements & payload of a remote sensing satellite? Give one example of remote sensing satellite.

PART B

(Answer one question from each module. Each question carries 14 mark.)

Module 1

- 11(a) State Kepler's laws of planetary motion. Using these laws determine the height of geostationary orbit (8)
- 11(b) Discuss the various satellite orbits and their applications. (6)

OR

- 12(a) Explain the need for stabilization of a space craft & methods to achieve it. (7)
- (b) Briefly describe the launching methods & Launch vehicles used for putting a spacecraft into geostationary orbit. (7)

Module 2

13. Discuss the major subsystems of a communication satellite. (14)

OR

14. With a block schematic describe a transmit receive earth station (14)

Module 3

15. Derive the uplink and downlink design of a geostationary Ku band satellite (14)

OR

- 16(a). Discuss the regional communication satellite of India (7)
- 16(b). How global coverage is possible using INTELSAT. What is the use of INMARSAT (7)

Module 4

17. Discuss the digital modulation techniques used in satellite communication. (14)

OR

18(a). Discuss the Random-access techniques and the associated protocols. (7)

18 (b). Compare FDMA,TDMA,CDMA. (7)

Module 5

19(a) Discuss direct broadcast satellite & satellite radio enumerating their advantages (7)

19(b) Discuss the weather forecasting satellites explaining the orbits chosen and the payload, and applications (7)

OR

20(a) Explain the functional system of a GPS. How position determined in GPS system and methods to reduce error (8)

20(b) Explain NGSO satellite constellations. (6)

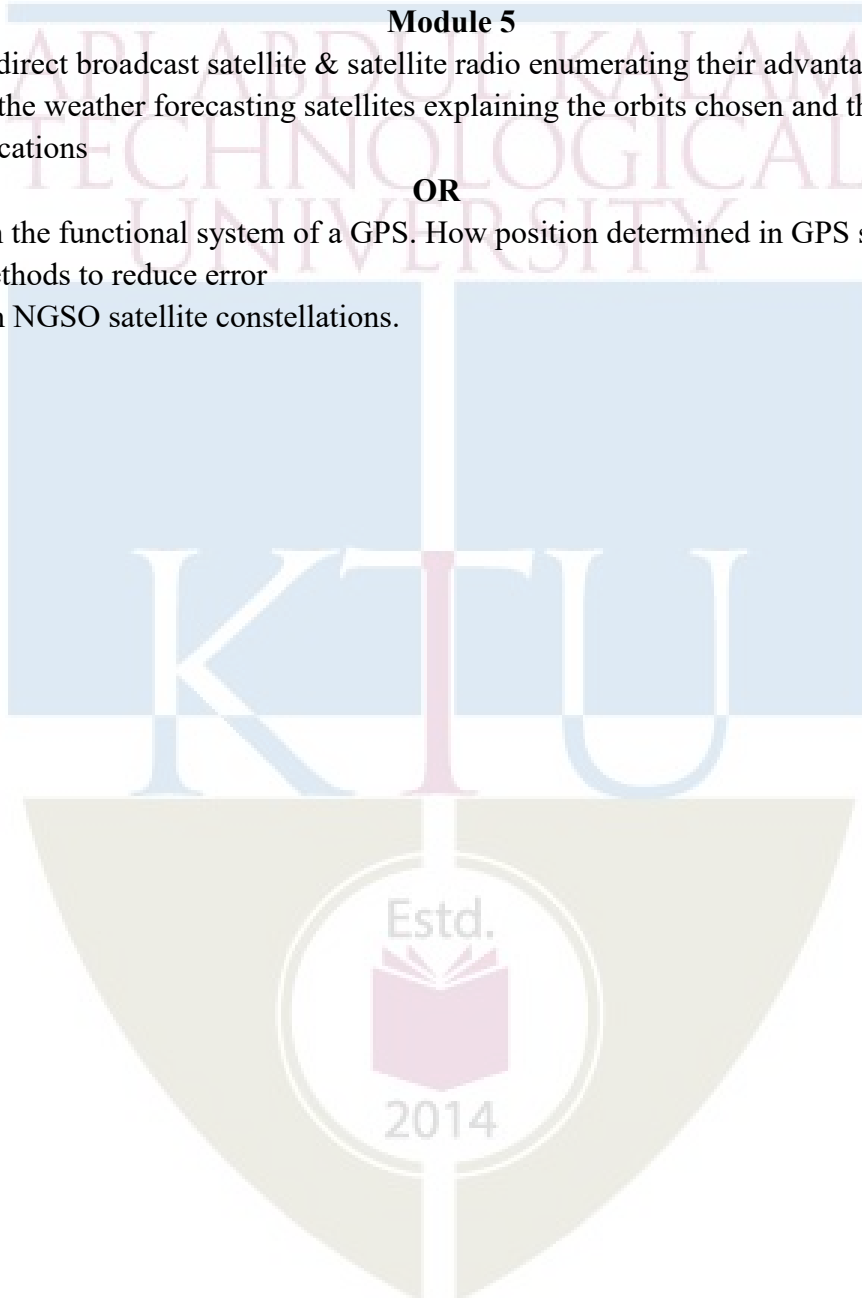

ECT434	SECURE COMMUNICATION	CATEGORY	L	T	P	CREDIT
		PEC	2	1	0	3

Preamble: This course aims to provide an insight into the theory and technology behind secure communication.

Prerequisite: Nil

Course Outcomes: After the completion of the course the student will be able to

CO 1 K2	Explain network security services and mechanisms and the types of attacks they are designed for
CO 2 K3	Model the symmetric encryption process and different encryption techniques
CO 3 K3	Apply the concepts of group, ring, field, modular arithmetic, Euclidean algorithm, Finite fields and polynomial arithmetic
CO4 K2	Illustrate the principles of modern symmetric ciphers like the Data Encryption Standard and Advanced Encryption Standard
CO5 K2	Outline the concepts of public key cryptography, RSA algorithm, key distribution and management for public key systems
CO6 K2	Explain the requirements for authentication and the types of functions used to produce an authenticator

Mapping of course outcomes with program outcomes

	PO 1	PO 2	PO 3	PO 4	PO 5	PO 6	PO 7	PO 8	PO 9	PO10	PO11	PO12
CO 1	3	3										2
CO 2	3	3										2
CO 3	3	3										2
CO 4	3	3										2
CO 5	3	3										2
CO 6	3	3										2

Assessment Pattern

Bloom's Category	Continuous Assessment Tests		End Semester Examination
	1	2	
Remember K1	10	10	10
Understand	20	20	20

K2			
Apply K3	20	20	70
Analyse			
Evaluate			
Create			

Mark distribution

Total Marks	CIE	ESE	ESE Duration
150	50	100	3 hours

Continuous Internal Evaluation Pattern:

Attendance	: 10 marks
Continuous Assessment Test (2 numbers)	: 25 marks
Assignment/Quiz/Course project	: 15 marks

End Semester Examination Pattern: There will be two parts; Part A and Part B. Part A contain 10 questions with 2 questions from each module, having 3 marks for each question. Students should answer all questions. Part B contains 2 questions from each module of which student should answer any one. Each question can have maximum 2 sub-divisions and carry 14 marks.

Course Level Assessment Questions

Course Outcome 1 (CO1): Explain network security services and mechanisms and the types of attacks they are designed for

1. Describe the OSI security architecture
2. Differentiate between active and passive security threats
3. Define the categories of security services and security threats

Course Outcome 2 (CO2): Explain the general model for the symmetric encryption process and some of the encryption techniques in use

1. Describe the five ingredients in a symmetric cipher model
2. Encrypt and decrypt plaintext using Hill cipher.
3. Describe one time pad.

Course Outcome 3 (CO3): Apply the concepts of group, ring, field, modular arithmetic, Euclidean algorithm, Finite fields and polynomial arithmetic

1. Define a group, ring and field

2. Determine the gcd of 2 given numbers.
3. Find the multiplicative inverse using extended Euclidean algorithm

Course Outcome 4 (CO4): Illustrate the principles of modern symmetric ciphers like the Data Encryption Standard and Advanced Encryption Standard

1. Explain avalanche effect
2. Describe the DES encryption algorithm
3. Describe ShiftRows transformation in AES

Course Outcome 5 (CO5): Describe the concepts of public key cryptography, RSA algorithm, key distribution and management for public key systems

1. Describe the key elements of a public key cryptosystem
2. Encrypt and decrypt using RSA algorithm
3. List the different schemes for distribution of public keys

Course Outcome 6 (CO6): Describe the requirements for authentication and the types of functions that may be used to produce an authenticator

1. What types of attacks are addressed by message authentication?
2. Explain the basic uses of message encryption
3. Explain the basic uses of Message Authentication Code

SYLLABUS

Module 1: Introduction and Classic Encryption Techniques

OSI security architecture, Security attacks – Passive attacks, Active attacks, Security services- Authentication, Access Control, Data Confidentiality, Data integrity, Nonrepudiation, Availability service. Model for network security. Symmetric cipher model, Cryptography, Cryptoanalysis, Substitution techniques- Hill Cipher, One time pad, Transposition Techniques

Module 2: Finite Fields

Groups, Rings and Fields, Modular arithmetic, Euclidian algorithm, Finite Fields of the form $GF(p)$, Polynomial arithmetic

Module 3: Block Ciphers. Data Encryption Standard, AES Cipher

Block Cipher Principles – Stream Ciphers and Block Ciphers, Feistel Cipher, Feistel Decryption algorithm, The Data encryption standard, DES Decryption - Avalanche effect, The AES Cipher, substitute bytes transformation, Shift row transformation, Mix Column transformation

Module 4: Public Key Cryptography, RSA and Key Management

Principles of public key cryptosystems-Public key cryptosystems, Application for Public key cryptosystem requirements, Fermat's theorem, Euler's Totient Function, Euler's theorem, RSA algorithm, Key management, Distribution of public keys, Publicly available directory, Public key authority, public key certificates, Distribution of secret keys using public key cryptography

Module 5: Message Authentication and Hash Function

Authentication requirements, Authentication functions- Message Encryption, Public Key Encryption, Message Authentication Code, Hash function

Text Books

1. William Stallings, Cryptography and Network security: principles and practice", 4th Edition, Prentice Hall of India, New Delhi, 2006

Reference Books:

1. Behrouz A. Forouzan, Cryptography and Network security Tata McGraw-Hill, 2008
2. David S. Dummit & Richard M Foote, Abstract Algebra, 2nd Edition, Wiley India Pvt. Ltd., 2008.
3. Douglas A. Stinson, Cryptography, Theory and Practice, 2/e, Chapman & Hall, CRC Press Company, Washington, 2005.
4. Lawrence C. Washington, Elliptic Curves: Theory and Cryptography, Chapman & Hall, CRC Press Company, Washington, 2008.
5. N. Koblitz: A course in Number theory and Cryptography, 2008
6. Thomas Koshy: Elementary Number Theory with Applications, 2/e, Academic Press, 2007
7. Tyagi and Yadav, Cryptography and network security, Dhanpatrai, 2012

Course Contents and Lecture Schedule

No	Topic	No. of Lectures
1	Introduction	
1.1	OSI system architecture, Security attacks – Passive attacks, Active attacks	1
1.2	Security services- Authentication, Access Control, Data Confidentiality, Data integrity, Nonrepudiation, Availability service. Security Mechanisms	2
1.3	A model for network security	1
1.4	Symmetric cipher model, Cryptography, Cryptoanalysis,	1
1.5	Substitution techniques- Hill Cipher, One time pad	2
1.6	Transposition Techniques	1
		8
2	Finite Fields	
2.1	Groups, Rings and Fields	1
2.2	Modular arithmetic	2
2.3	Euclidian algorithm	1
2.4	Finite Fields of the form $GF(p)$	2
2.5	Polynomial arithmetic	2
		8
3	Block Ciphers. Data Encryption Standard, AES Cipher	
3.1	Block Cipher Principles – Stream Ciphers and Block Ciphers, Feistel Cipher, Feistel Decryption algorithm	2
3.2	The Data encryption standard, DES Decryption – The Avalanche effect	3
3.3	The AES Cipher, substitute bytes transformation, Shift row transformation, Mix Column transformation	4
		9
4	Public Key Cryptography, RSA and Key Management	
4.1	Principles of public key cryptosystems-Public key cryptosystems, Application for Public key cryptosystem requirements	2
4.2	Fermat's theorem, Euler's Totient Function, Euler's theorem, RSA algorithm- Description of the algorithm	3
4.3	Key management, Distribution of public keys, Publicly available directory, Public key authority, public key certificates, Distribution of secret keys using public key cryptography	2
		7
5	Module 5: Message Authentication and Hash Function	
5.1	Authentication requirements, Authentication functions- Message Encryption, Public Key Encryption, Message Authentication Code, Hash function	3
		3

Simulation Assignments: (Using Matlab/Python or any suitable software)

1. Write a program that can encrypt and decrypt using a 2x2 Hill cipher
2. Write a program that can encrypt and decrypt a railfence cipher
3. Write a program to find the multiplicative inverse using extended Euclidean algorithm
4. Write a program for calculating Euler's Totient Function

Model Question paper

APJ ABDUL KALAM TECHNOLOGICAL UNIVERSITY
EIGHTH SEMESTER B.TECH DEGREE EXAMINATION

Course Code: ECT434

Course Name: SECURE COMMUNICATION

Max. Marks: 100

Duration: 3 Hours

PART A

Answer ALL Questions. Each Carries 3 mark.

1	Illustrate the categories of active attacks	K2
2	Express Hill Cipher system in general terms. Describe the strength of the Hill Cipher.	K2
3	Determine whether the set of residue class modulo 3 forms a group with respect to addition.	K3
4	Determine the multiplicative inverse of each non zero element in Z_5	K3
5	Differentiate between diffusion and confusion	K2
6	Differentiate between block cipher and stream cipher	K2
7	State and prove Fermats theorem	K2
8	Explain the requirements for public key cryptography	K2
9	Define the types of attacks which can be addressed by message authentication	K2
10	Define the 3 classes of functions which can be used to produce an authenticator.	K2
PART – B		
Answer one question from each module; each question carries 14 marks.		
Module - I		
11 a.	Describe specific and pervasive security mechanisms	7 CO1

		K2
b.	Decrypt the following message that was encrypted by using a railfence cipher with 4 rails. TTTPT QDSYP RSHII XEDOH EIUNS ESLDY TEMES SERSE NELSC NEAUC FLERE GAMAE BHDIH SCUCD NG	7 CO2 K3
	OR	
12 a.	Describe a symmetric cipher model	7 CO1 K2
b.	Encrypt the message: “payransom” using Hill Cipher with the key $\begin{pmatrix} 5 & 1 \\ 2 & 7 \end{pmatrix}$.	7 CO2 K3
	Module - II	
13 a.	Define a field.	7 CO3 K2
b.	Find the gcd (24140, 16762)	7 CO3 K3
	OR	
14 a.	Using the extended Euclidean algorithm, find the multiplicative inverse of 1234 mod 4321	7 CO3 K3
b.	Calculate using coefficients in Z_{10} (a) $(7x+2) - (x^2+5)$ (b) $(6x^2+x+3) \times (5x^2+2)$	7 CO3 K3
	Module - III	
15 a.	Describe the internal structure of a single round of DES Encryption algorithm	8 CO4 K2
b.	In an AES system, given the plaintext {000102030405060708090A0B0C0D0E0F} and the key {010101010101010101010101010101}, (a) Show the original contents of State , displayed as a 4x4 matrix (b) Show the value of State after initial Add Round Key Describe the characteristics of the AES Cipher	6 CO4 K3
	OR	

16	What are the parameters and design choices that determine the actual algorithm of a Feistel Cipher. Describe Feistel Encryption and Decryption.	14 CO4 K2
Module - IV		
17 a.	State and prove Euler's theorem	6 CO5 K2
b.	Using Fermat's Theorem, find (i) $3^{201} \text{ mod } 11$ (ii) a number a between 0 and 72 with a congruent to 9794 modulo 73	8 CO5 K3
OR		
18 a.	Describe the essential elements of a public key cryptosystem scheme	7 CO5 K2
b.	Perform encryption and decryption using RSA algorithm for $p = 3, q = 11, e = 7, M = 5$.	7 CO5 K3
Module - V		
19	Describe a hash function. Illustrate the different ways in which hash function can be used to provide message authentication. Describe the confidentiality and authentication implications of the different approaches.	14 CO6 K2
OR		
20(a)	Illustrate the basic uses of message encryption	7 CO6 K2
(b)	Explain authentication using message authentication code	7 CO6 K2

ECT444	PATTERN RECOGNITION	CATEGORY	L	T	P	CREDIT
		PEC	2	1	0	3

Preamble: This course aims to impart the fundamentals of statistical pattern recognition and neural network techniques.

Prerequisite: MAT 101 Linear Algebra and Calculus, MAT 204 Probability, Random Process, and Numerical Methods, ECT 463 Machine Learning

Course Outcomes: After the completion of the course the student will be able to

CO1 K2	Understand the basics of statistical pattern recognition
CO2 K3	Apply statistical methods in linear classification
CO3 K3	Apply linear algebra and statistical methods in parameter and non-parameter estimation
CO4 K3	Apply statistical methods in non-linear classification and neural networks
CO5 K2	Understand the basics of deep learning networks, convolutional neural networks

Mapping of course outcomes with program outcomes

	PO1	PO2	PO3	PO4	PO5	PO6	PO7	PO8	PO9	PO10	PO11	PO12
CO 1	3											
CO 2	3	3	3	3	3							
CO 3	3	3	3	3	3							
CO 4	3											
CO 5	3			3	3							

Assessment Pattern

Bloom's Category	Continuous Assessment Tests		End Semester Examination
	1	2	
Remember			
Understand K2	20	20	40
Apply K3	30	30	60
Analyse			
Evaluate			
Create			

Mark distribution

Total Marks	CIE	ESE	ESE Duration
150	50	100	3 hours

Continuous Internal Evaluation Pattern:

Attendance	: 10 marks
Continuous Assessment Test (2 numbers)	: 25 marks
Assignment/Quiz/Course project	: 15 marks

End Semester Examination Pattern: There will be two parts; Part A and Part B. Part A contain 10 questions with 2 questions from each module, having 3 marks for each question. Students should answer all questions. Part B contains 2 questions from each module of which student should answer any one. Each question can have maximum 2 sub-divisions and carry 14 marks.

Course Level Assessment Questions

Course Outcome 1 (CO1): Understand the basics of statistical pattern recognition (K2)

1. Describe the classification of pattern recognition systems
2. Describe statistical pattern recognition

Course Outcome 2 (CO2): Apply statistical methods in linear classification (K3)

1. Describe linear classifiers
2. Obtain linear classifiers using statistical methods

Course Outcome 3 (CO3): Apply linear algebra and statistical methods in parameter and non-parameter estimation (K3)

1. Explain different parameter estimation methods
2. Describe different non-parameter estimation methods

Course Outcome 4 (CO4): Apply statistical methods in non-linear classification and neural networks (K3)

1. Explain non-linear classifiers, neural networks and various associated terms
2. Using optimization techniques obtain the backpropagation algorithm

Course Outcome 5 (CO5): Understand the basics of deep learning networks, convolutional neural networks, and recurrent neural networks(K2)

1. Describe deep learning networks
2. Explain convolutional neural networks and its layers.

SYLLABUS

Module I

Basics of pattern recognition system, various applications, classification of pattern recognition systems, design of Pattern recognition system. Statistical pattern recognition: review of probability theory, Gaussian distribution, Bayes decision theory, optimal solutions for minimum error and minimum risk criteria.

Module II

Linear Classifiers, linearly separable classes, normal density, discriminant functions, decision surfaces, linear discriminants, binary class, multiple classes, cost functions, perceptron algorithm, SVM, Fisher's linear discriminant.

Module III

Parameter estimation methods: Maximum-Likelihood estimation, Bayesian parameter estimation, mixture models, mixtures of Gaussians, Expectation-maximization method.

Non-Parameter methods: Non-parametric techniques for density estimation - Parzen-window method, K-nearest neighbour density estimation, nearest neighbor rule.

Module IV

Nonlinear classifiers, the XOR problem, two-layer multilayer perceptrons, multilayer perceptrons, neural networks, feed-forward networks, hidden units, activation function, weight vector, bias, cost functions, forward and backward propagation, learning by gradient descent, backpropagation algorithm.

Module V

Introduction to deep learning networks, deep feedforward networks, ReLU, bias-variance tradeoff, regularization, dropout, vanishing/exploding gradients, weight initialization for deep networks, basics of convolutional neural networks, layers of convolutional neural networks.

Text Books:

1. Bishop, C. M. "Pattern Recognition and Machine Learning" Springer, New York, 2006.
2. Duda, R.O., Hart, P.E., and Stork, D.G. "Pattern Classification". Wiley, New York, 2001.

References:

1. Hastie, T., Tibshirani, R. and Friedman, J. "The Elements of Statistical Learning". Springer. 2001.
2. Theodoridis, S. and Koutroumbas, K. "Pattern Recognition". Academic Press, San Diego, 2003.
3. Ian Goodfellow, Yoshua Bengio, Aaron Courville. "Deep Learning" MIT Press, 2016
4. Morton Nadier and Eric Smith P., Pattern Recognition Engineering , John Wiley & Sons, New York, 1993.

Course Contents and Lecture Schedule

No	Topic	No. of Lectures
1	Module I	
1.1	Basics of pattern recognition system, various applications,	1
1.2	types of pattern recognition systems, design of Pattern recognition system.	1
1.3	Statistical pattern recognition: review of probability theory	2
1.4	Bayes decision theory, optimal solutions for minimum error and minimum risk criteria.	2
2	Module II	
2.1	Linear Classifiers, linearly separable classes, normal density,	2
2.2	discriminant functions, decision surfaces,	1
2.3	linear discriminants, binary class, multiple classes, cost functions,	2
2.4	perceptron algorithm, SVM ,Fisher's linear discriminant.	2
3	Module III	
3.1	Parameter estimation methods: Maximum-Likelihood estimation,	2
3.2	Bayesian parameter estimation,	1
3.3	mixture models, mixtures of Gaussians, Expectation-maximization method.	2
3.4	Non-parametric techniques for density estimation - Parzen-window method,	2
3.5	K-nearest neighbour density estimation, nearest neighbor rule.	1

4	Module IV	
4.1	Nonlinear classifiers, the XOR problem, two-layer multilayer perceptrons,	2
4.2	multilayer perceptrons, neural networks, feed-forward networks,	1
4.3	hidden units, activation function, weight vector, bias, cost functions,	1
4.4	forward and backward propagation, learning by gradient descent, backpropagation algorithm.	3
5	Module V	
5.1	Introduction to deep learning networks, deep feedforward networks,	2
5.2	ReLU, bias-variance tradeoff, regularization, dropout,	2
5.3	vanishing/exploding gradients, weight initialization for deep networks,	1
5.4	basics of convolutional neural networks, layers of convolutional neural networks	2

Simulation Assignments (using Python or Matlab)

- Linear classifiers
- Maximum likelihood estimation,
- Bayesian estimation
- Expectation-maximization method.
- Multilayer perceptrons
- backpropagation
- Deep learning examples
- Basic CNN

Model Question Paper

**APJ ABDULKALAM TECHNOLOGICAL UNIVERSITY
MODEL QUESTION PAPER**

ECT444 PATTERN RECOGNITION

Time: 3 hours

Max.Marks:100

PART A

Answer *all* questions. Each question carries **3 marks**.

1. Explain different types of pattern recognition systems with examples.
2. Explain Bayes classification rule
3. Explain the significance of minimizing risk
4. Describe discriminant functions and decision surfaces
5. Explain Fisher's linear discriminant.
6. Differentiate ML and MAP parameter estimation.
7. Explain the significance of Gaussian mixture models
8. Explain activation functions.
9. Explain vanishing and exploding gradients.
10. How weight initialization is done for deep networks.

PART B

Answer *anyone* question from each module. Each question carries **14 marks**.

MODULE I

11. (a) Describe the design principles of pattern recognition system with an example(6 marks)
 (b) Explain Bayes decision rule. Explain how it can be used for two class classification. (8 marks)

OR

12. (a) Show that the Bayesian classifier is optimal with respect to minimizing the classification error probability? (8 marks)
 (b) Give any three applications of pattern recognition systems (6 marks)

MODULE II

13. (a) Give a description of minimum distance classifiers (8 marks)
 (b) Explain Fisher's linear discriminant. (6 marks)

OR

14. (a) Obtain the decision surface for an equi-probable two class system, where the probability density functions of n-dimensional feature vectors in both classes are normally distributed. (8 marks)
 (b) Give step by step description of perceptron algorithm (6 marks)

MODULE III

15. (a) Assuming a Gaussian distribution of the features, Explain the general principle of the maximum likelihood estimation for the following cases

1. Unknown mean and known covariance matrix
 2. Unknown mean and unknown covariance matrix (8 marks)
- (b) Compare parametric and non parametric methods for probability density function estimation. (6 marks)

OR

16. (a) Give step by step description of expectation maximization algorithm. (8 marks)
- (b) How mixture models are created using Gaussian densities? (6 marks)

MODULE IV

17. (a) Explain the working principle of back propagation neural networks with neat architecture diagram (8 marks)
- (b) List different types of activation functions used in perceptron models. (6 marks)

OR

18. (a) How does a multi-layer perceptron solve the nonlinear XOR problem? (8 marks)
- (b) Explain weight vector, bias, cost functions (6 marks)

MODULE V

19. (a) Explain convolutional layer, pooling layers and activation functions in convolutional neural networks. (6 marks)
- (b) Give the structure of deep neural networks with description of all layers (8 marks)

20. (a) Describe convolutional neural networks with detailed description of each layers (8 marks)
- (b) Explain i) ReLU, ii) regularization, iii) dropout (6 marks)



ECT454	RF CIRCUIT DESIGN	CATEGORY	L	T	P	CREDIT
		PEC	2	1	0	3

Preamble: This course deals with the analysis, design and simulation of Radio Frequency (RF) Circuits and Components for wireless communication systems. The course provides fundamentals of transmission lines, high frequency circuit behavior, impedance matching networks, filters, active RF components, amplifiers, and mixers. The course will enable the students to use CAD tools for simulating and designing RF circuits.

Prerequisite: ECT 302 Electromagnetics, ECT 202 Analog Circuits and ECT 205 Network Theory

Course Outcome: After the completion of the course the student will be able to

CO 1 K2	Explain the basic idea about RF networks and working of RF filter circuits
CO 2 K2	Describe the behaviour of RF components and application of Network analyser in parameter measurement
CO 3 K3	Apply the principle of RF networks in the designing of RF amplifiers, RF Oscillators and Mixers

Mapping of course outcomes with program outcomes

	PO 1	PO 2	PO 3	PO 4	PO 5	PO 6	PO 7	PO 8	PO 9	PO 10	PO 11	PO 12
CO 1	3	3	2		2							2
CO 2	3	3	2		3							2
CO 3	3	3	3		3			2				2

Assessment Pattern

Bloom's Category		Continuous Assessment Tests		End Semester Examination
		1	2	
Remember	K1	10	10	20
Understand	K2	20	20	40
Apply	K3	20	20	40
Analyse				
Evaluate				
Create				

Mark distribution

Total Marks	CIE	ESE	ESE Duration
150	50	100	3 hours

Continuous Internal Evaluation Pattern:

Attendance	: 10 marks
Continuous Assessment Test (2 numbers)	: 25 marks
Assignment/Quiz/Course project	: 15 marks

End Semester Examination Pattern: There will be two parts; Part A and Part B. Part A contain 10 questions with 2 questions from each module, having 3 marks for each question. Students should answer all questions. Part B contains 2 questions from each module of which student should answer any one. Each question can have maximum 2 sub-divisions and carry 14 marks.

Course Level Assessment Questions

Course Outcome 1 (CO1) : Explain the basic idea about RF networks and working of RF filter circuits (K2)

1. Explain the high frequency behavior of inductors
2. What do mean by characteristic impedance of a transmission line ? Give expressions
3. Give the scattering matrix for a two-port network and define each element of the matrix.
4. Explain the steps involved in the design of a filter using insertion loss technique

Course Outcome 2 (CO2): Describe the behaviour of RF components and application of Network analyser in parameter measurement (K2)

1. Describe the different physical geometry structures for high frequency BJT fabrication.
2. Explain how impedance matching is done using Quarter-wave transformers
3. Describe the steps involved in simulating an RF circuit using any EM Simulation software
4. Explain the working of a Vector Network Analyzer

Course Outcome 3 (CO3): Apply the principle of RF networks in the designing of RF amplifiers, RF Oscillators and Mixers(K3)

1. Explain the importance of stability circles in designing Microwave Amplifiers.
2. Design a single stage transistor for maximum gain
3. Describe the working principle of a negative resistance oscillator
4. Explain the working of a Dielectric resonator oscillator.

SYLLABUS

Module 1 : Introduction to RF System (07 Hours)

- 1.1 **RF circuit introduction** - Importance of radio frequency design, RF behavior of resistors , inductors and capacitors.(02)
- 1.2 **Transmission Lines**-Equivalent Circuit representation-General Transmission Line Equation- Terminated transmission lines- Input impedance, Standing waves, VSWR, Return loss, Insertion loss, Characteristic impedance, Phase velocity.
Planar Transmission Lines – Microstrip lines and Striplines – Constructional Features (05)

Module 2 :RF Network Analysis (08 Hours)

- 2.1 **Single and Multi-port Networks**– Definitions-Impedance matrix, Scattering matrix, Transmission (ABCD) matrix(02)
- 2.2 **Impedance Matching Networks**-Design of Matching Circuits using Lumped Elements, Single Stub tuning, Quarter-Wave Transformers, Multi-Section Transformer – Binomial Transformer(04)
- 2.3 **RF Filter Design**- Filter Design using insertion loss technique – (02)

Module 3 :RF Components (07 Hours)

- 3.1 **Active RF components**- Bipolar junction Transistor – Construction-Functionality-Power Frequency Limitations of High Frequency transistors.GaAs devices - Familiarization of RF Field Effect Transistors and High Electron Mobility Transistors–Constructional details (04)
- 3.2 **RF circuit measurements and characterization**- Using Vector Network analyzer - S parameter, Reflection Coefficient and Insertion lossMeasurement (02)
- 3.3 **Modeling and Simulation of RF circuits using** – Open source or Commercial EM Simulation Softwares(01)

Module 4:Radio Frequency Amplifiers (07 Hours)

- 4.1 **Amplifier design using S-parameters** - Characteristics of Amplifier Power Relations, Stability Considerations – Stability Circles, Tests for Unconditional Stability -(04)
- 4.2 **High frequency amplifier design** – Single stage amplifier Design – Design for maximum gain, Low noise amplifier design (03)

Module 5: Radio Frequency Oscillators and Mixers (07 Hours)

- 5.1 **Basic oscillator model** -Feedback oscillator design—Negative Resistance Oscillator-Dielectric Resonator Oscillator - YIG Tuned Oscillator (04)

5.2 Mixer - Basic characteristics – Single-Ended Mixer Design, Single-balanced and double-balanced mixers (03)

Text Books

1. Ludwig, Reinhold. *RF Circuit Design: Theory & Applications*, 2/e. Pearson Education India, 2000.
2. Pozar, David M. *Microwave and RF design of wireless systems*. John Wiley & Sons, 2000

Reference Books

1. Radmanesh, Matthew M. *Advanced RF & microwave circuit design: the ultimate guide to superior design*. AuthorHouse, 2008.
2. Carr, Joseph J. *Secrets of RF circuit design*. McGraw-Hill Education, 2001.
3. Misra, Devendra K. *Radio-frequency and microwave communication circuits: analysis and design*. John Wiley & Sons, 2012.
4. Mathew M. Radmanesh, “Radio Frequency & Microwave Electronics”, 2nd Edition, Pearson Education Asia, 2002.
5. Rohde, Ulrich L., and David P. Newkirk. *RF/microwave circuit design for wireless applications*. John Wiley & Sons, 2000.
6. Davis, W. Alan, and Krishna Kumar Agarwal. *Radio frequency circuit design*. John Wiley, 2001.
7. Christopher, Bowick, Ajluni Cheryl, and Blyler John. *RF Circuit Design*. Newnes, 2007.
8. Abrie, Pieter LD. *Design of RF and microwave amplifiers and oscillators*. Artech House, 1999.

Course Contents and Lecture Schedule

No	Topic	No. of Lectures
1	Introduction to RF System07	
1.1	Introduction to RF circuits- Importance of radio frequency design, RF behaviour of resistors , Inductors and capacitors	2
1.2	Transmission Lines- Equivalent Circuit representation- General Transmission Line Equation	1
1.2	Terminated transmission lines –Input Impedance	1
1.2	Standing waves, VSWR, Return loss, Insertion loss, Characteristic impedance,	1
1.2	Planar Transmission Lines – Microstrip lines and Striplines – Constructional Features	2

2	RF Network Analysis	08
2.1	Single and Multi-port Networks- Impedance matrix, Scattering matrix, Transmission (ABCD) matrix	2
2.2	Impedance matching Network- Design of Matching Circuits using Lumped Elements, Single Stub Matching	2
2.2	Quarter-Wave Transformers, Multi-Section Transformer – Binomial Transformer	2
2.3	RF Filter Design - Filter Design using insertion loss technique	2
3	RF Components	07
3.1	Active RF components - Bipolar junction Transistor – Construction - Functionality-Power Frequency Limitations of High Frequency transistor	2
3.1	GaAs devices - Familiarization of RF Field Effect Transistors and High Electron Mobility Transistors – Constructional details	2
3.2	RF circuit measurements and characterization - Using Vector Network analyzer - S parameter, Reflection Coefficient and Insertion loss Measurement	2
3.3	Modelling and Simulation of RF circuits using – Opensource/Commercial EM simulation software's	1
4	RF Amplifiers	07
4.1	Amplifier design using S-parameters- Characteristics of Amplifier Power Relations	2
4.1	Stability Considerations – Stability Circles, Tests for Unconditional Stability	2
4.2	High frequency amplifier design– Single stage amplifier Design – Design for maximum gain,	2
4.2	Low noise amplifier design	1
5	RF Oscillators and Mixers	07
5.1	Basic oscillator model-Feedback oscillator design—Negative Resistance Oscillator	2
5.1	Dielectric Resonator Oscillator- YIG Tuned Oscillator	2
5.2	Mixer - Basic characteristics – Single-Ended Mixer Design	2
5.2	Single-balanced and double- balanced mixers	1

Model Question paper**APJ ABDUL KALAM TECHNOLOGICAL UNIVERSITY****EIGHTH SEMESTER B.TECH DEGREE EXAMINATION****Course Code: ECT454****Course Name: RF CIRCUIT DESIGN**

Max. Marks: 100

Duration: 3 Hours

PART A

(Answer ALL Questions. Each Question Carries 3 Marks.)

1. Explain how the capacitor behave at high frequencies
2. Derive the expression for the input reflection coeff(Γ_{in}), source reflection coeff(Γ_s), and output reflection coeff (Γ_{out}), of a loaded transmission line.
3. What is scattering matrix? Give the scattering parameters of a two port network.
4. How the impedance matching is performed with quarter wave transformer?
5. Describe the features of HEMT.
6. Explain how S-parameter measurement is done using vector network analyser
7. Explain how will you check whether a transistor is unconditionally stable or not
8. How the input VSWR and Output VSWR affects the design of amplifiers?
9. Explain the principle of negative resistance oscillators.
10. What is Inter Modulation Distortion (IMD)? [10 X 3= 30]

PART – B

(Answer one question from each module; each question carries 14 marks)

Module – I

11. (a) Explain the terms i)VSWR ii)Return loss iii) Characteristic impedance . [07 Marks]
(a) How the inductor coils behave at high frequencies ? [07Marks]

OR

12. (a)How the resistors behave at high frequency? Give the electric equivalent circuit representation of a high frequency resistor. [07 Marks]
(b). What is lossless transmission line? Derive expression for Characteristic impedance of a lossless transmission line [07 Marks]

Module – II

13. (a) Explain the steps involved in the design of filter using the Insertion Loss Technique ? [08 Marks]
(b) What is transmission parameter matrix? Derive the same for a T network. [06 Marks]

OR

14. (a) With the help of neat sketches explain how single stub tuning is done. [07 Marks]
- (b) Design a binomial transformer for to match 50Ω to a 75Ω line and calculate the bandwidth for $\Gamma_m = 0.03$. [07 Marks]

Module – III

15. (a) With the help of a neat block diagram explain the working of Vector network analyzer. [07 Marks]
- (b) What is power frequency limitation of high frequency power transistors? Explain. [07 Marks]

OR

16. (a) Explain the steps involved in designing a circuit using any EM simulation software [08 Marks]
- (b) Draw the cross sectional view of HEMT device and explain the working of the same device. [06 Marks]

Module – IV

17. (a) Derive the expression for the Unilateral Power gain G_{TU} of an amplifier. [07 Marks]
- (b) Explain how a low noise amplifier is designed [07 Marks]

OR

18. (a) What is the radius and center of an output stability circle of a RF amplifier? [07 Marks]
- (b) How will you design a single stage amplifier for maximum gain ? [07 Marks]

Module V

19. (a) Explain the working principle of a negative resistance oscillator [07 Marks]
- (b) With the help of neat sketches explain the working of YIG tuned Oscillator. [07 Marks]

OR

20. (a) Derive the S matrix for the dielectric resonator oscillator . [07 Marks]
- (b) Draw the neat circuit diagram for a double balanced diode mixer circuit and explain the working of the same. [07 Marks]

ECT464	MIXED SIGNAL CIRCUIT DESIGN	CATEGORY	L	T	P	CREDIT
		PEC	2	1	0	3

Preamble: This course aims to analyse various CMOS analog and digital mixed signal circuits.

Prerequisite: ECT 202 ANALOG CIRCUITS, ECT 203 LOGIC CIRCUIT DESIGN

Course Outcomes: After the completion of the course the student will be able to

CO1/K3	Implement various analog and digital CMOS subcircuits
CO2/K4	Analyse various CMOS amplifiers
CO3/K4	Analyse Data Converters

Mapping of course outcomes with program outcomes

	PO0 1	PO0 2	PO0 3	PO0 4	PO0 5	PO0 6	PO0 7	PO0 8	PO0 9	PO1 0	PO1 1	PO1 2
CO 1	3	3										2
CO 2	3	3										2
CO 3	3	3										2

Assessment Pattern

Bloom's Category		Continuous Assessment Tests		End Semester Examination
		1	2	
Remember	K1	10	10	10
Understand	K2	20	20	20
Apply	K3	20	20	70
Analyse				
Evaluate				
Create				

Mark distribution

Total Marks	CIE	ESE	ESE Duration
150	50	100	3 hours

Continuous Internal Evaluation Pattern:

Attendance	: 10 marks
Continuous Assessment Test (2 numbers)	: 25 marks
Assignment/Quiz/Course project	: 15 marks

End Semester Examination Pattern: There will be two parts; Part A and Part B. Part A contain 10 questions with 2 questions from each module, having 3 marks for each question. Students should answer all questions. Part B contains 2 questions from each module of which student should answer any one. Each question can have maximum 2 sub-divisions and carry 14 marks.

Course Level Assessment Questions

Course Outcome 1: Implement various analog and digital CMOS subcircuits

1. Analyse MOS with different load conditions.
2. Design of current mirror circuits

Course Outcome 2 Analyse various CMOS amplifiers

1. Analyse CMOS CS Amplifiers for various load conditions.
2. Explain various circuit technique for improving gain of Opamp
3. Design of Two stage opamp for different load condition

Course Outcome 3 Analyse Data Converters

1. Explain various non idealities in DAC and ADC.
2. Design of ADC's for given specification (eg: 6 Bit 100 MHz Folding ADC).

SYLLABUS

Module 1:CMOS Amplifiers

Active load: MOS resistor, MOS current source, diode connected MOS.

CMOS Amplifiers: Common source amplifier with resistive and active loads, Common source amplifier with source degeneration, Common gate and Common drain amplifier (only voltage gain and input and output impedances of the circuits).

Module 2:CMOS Differential Amplifiers

MOS Current Mirror: Simple, Cascode and Wilson current mirror circuits.

CMOS Differential Amplifier: Differential Amplifier with resistive, current source, with current mirror and cascode loads(only voltage gain and input and output impedance of the circuits).

Module 3:CMOS Operational Amplifier

Opamp Performance parameters, Single stage and two stage op-amps with different types of load. Gain Boosting in Opamp

Module 4:References and Switched Capacitor Circuits

References: Supply Independent Biasing, Temperature independent references– band gap reference.

Switched Capacitor Circuits: Switched capacitor resistor, Switched Capacitor Integrator, 1st order filter.

Module 5: Data Converters

DAC: Non-idealities in DAC, Types: Resistive, Charge redistribution, Voltage Scaling, Cyclic and Pipelined.

ADC: Non-idealities in ADC, Sample and Hold circuit, quantization errors, Types of ADC : Flash, two step, pipelined, successive approximation, Folding.

Text Books:

1. Behzad Razavi, "Design of Analog CMOS Integrated Circuits", McGraw-Hill, 2/e, 2002
2. Meyer Gray, Hurst, Lewis, "Analysis and Design of Analog Integrated Circuits", 5th Edition, Wiley 2009

Reference Books:

1. Phillip E. Allen, Douglas R. Holbery, CMOS Analog Circuit Design, Oxford, 2004.
2. Razavi B., Fundamentals of Microelectronics, Wiley student Edition 2014.
3. Baker, Li, Boyce, CMOS: Circuits Design, Layout and Simulation, PHI, 2000

Course Contents and Lecture Schedule

No.	Topic	Hrs.
1	CMOS Amplifiers	
1.1	MOS basics.	1
1.2	MOS resistor, MOS current source, diode connected MOS.	2
1.3	Common source amplifier with resistive and active loads, Common source amplifier with source degeneration.	3
1.4	Common gate amplifier.	1
1.5	Common drain amplifier.	1
2	CMOS Differential Amplifiers	
2.1	Simple current mirror, Cascode and Wilson current mirrors.	1
2.2	Differential Amplifier with resistive load.	1
2.3	Differential Amplifier with current source and current mirror loads.	2
2.4	Differential Amplifier with cascode load.	2
3	CMOS Operational Amplifier	
3.1	Opamp Performance Parameters	1
3.2	Single stage op-amp with resistive and active loads.	2
3.3	Two stage op-amp with resistive and active loads.	2
3.4	Gain Boosting in Opamp	1
4	References and Switched Capacitor Circuits	
4.1	Supply Independent Biasing.	1
4.2	Temperature independent reference- Negative and Positive T C Voltage	1
4.3	Bandgap reference.	1
4.4	Switched capacitor resistor, Switched Capacitor Integrator	2
4.5	1 st order filter.	1
5	Module 5: Data Converters	
5.1	DAC non-idealities, Resistive DAC, Charge redistribution DAC.	1

5.2	Voltage Scaling DAC, Cyclic and Pipelined DAC.	2
5.3	ADC non-idealities,	1
5.4	Sample and Hold circuit.	1
5.5	Quantization errors.	1
5.6	ADC Types:Flash, two step, pipelined, successive approximation, folding ADC	3
Total Hours		35

Simulation Assignments:

Atleast one assignment should be simulation of the circuits. The simulations can be done in QUCS, KiCad or PSPICE.

Model Question paper

APJ ABDUL KALAM TECHNOLOGICAL UNIVERSITY

EIGHTH SEMESTER B.TECH DEGREE EXAMINATION

Course Code: ECT464

Course Name: MIXED SIGNAL CIRCUIT DESIGN

Max. Marks: 100

Duration: 3 Hours

PART A

Answer ALL Questions. Each Carries 3 mark.

1	Write down the expression for drain current of an NMOS transistor in active and saturation regions.	K1
2	Draw the small signal model of low frequency MOSFET.	K1
3	State the significance of diode connected transistor in current mirror circuits.	K2
4	Differentiate between cascade and cascode configurations.	K2
5	What is the significance of tail current source in a differential amplifier?	K2
6	What is the purpose of stage 1 and stage 2 amplifiers in a 2-stage op-amp?	K2
7	What are the important parameters that are to be considered while designing reference circuits?	K1
8	Derive the equivalent resistance of a series switched capacitor resistor.	K3
9	Mention any two non-idealities of a DAC.	K2
10	What is quantization error in an ADC?	K2
PART – B		
Answer one question from each module; each question carries 14 marks.		
Module - I		
11a.	Draw the circuit diagram and derive the equivalent resistance of a MOS resistor.	4 CO1 K3
b.	Derive the voltage gain and output impedance of common source amplifier.	10 CO2 K3
OR		
12a.	Draw the circuit diagram and derive the equivalent resistance of a MOS current	4

	source.	CO1 K3
b.	Derive the voltage gain and output impedance of common gate amplifier.	10 CO2 K3
Module - II		
13a.	Derive the output impedance of simple current mirror	6 CO1 K3
b.	Derive the voltage gain and output impedance of Differential Amplifier with current source load.	8 CO2 K3
OR		
14	Derive the voltage gain and output impedance of Differential Amplifier with current mirror load.	14 CO2 K3
Module - III		
15	Draw the circuit diagram and derive the voltage gain and output impedance of a simple op-amp with cascade load.	14 CO2 K3
OR		
16	Draw the circuit diagram and derive the voltage gain and output impedance of a 2-stage op-amp with NMOS inputs.	14 CO2 K3
Module - IV		
17a.	Draw the circuit diagram and explain the working of supply independent biasing circuit	5 CO3 K3
b.	Draw the circuit diagram and derive the transfer function of parasitic sensitive switched capacitor integrator.	9 CO3 K3
OR		
18	Draw the circuit diagram and derive the transfer function of general 1 st order switched capacitor filter. Also mention the circuits for high pass and low pass filters.	14 CO3 K3
Module - V		
19a.	Derive the expression for SNR of a DAC	5 CO3 K3
b.	Draw the circuit diagram and explain the working of pipeline DAC	9 CO3 K3
OR		

20a.	Explain INL and DNL errors in data converters.	5 CO3 K3
b.	Draw the circuit diagram and explain the working of successive approximation ADC	9 CO3 K3

APJ ABDUL KALAM
TECHNOLOGICAL
UNIVERSITY

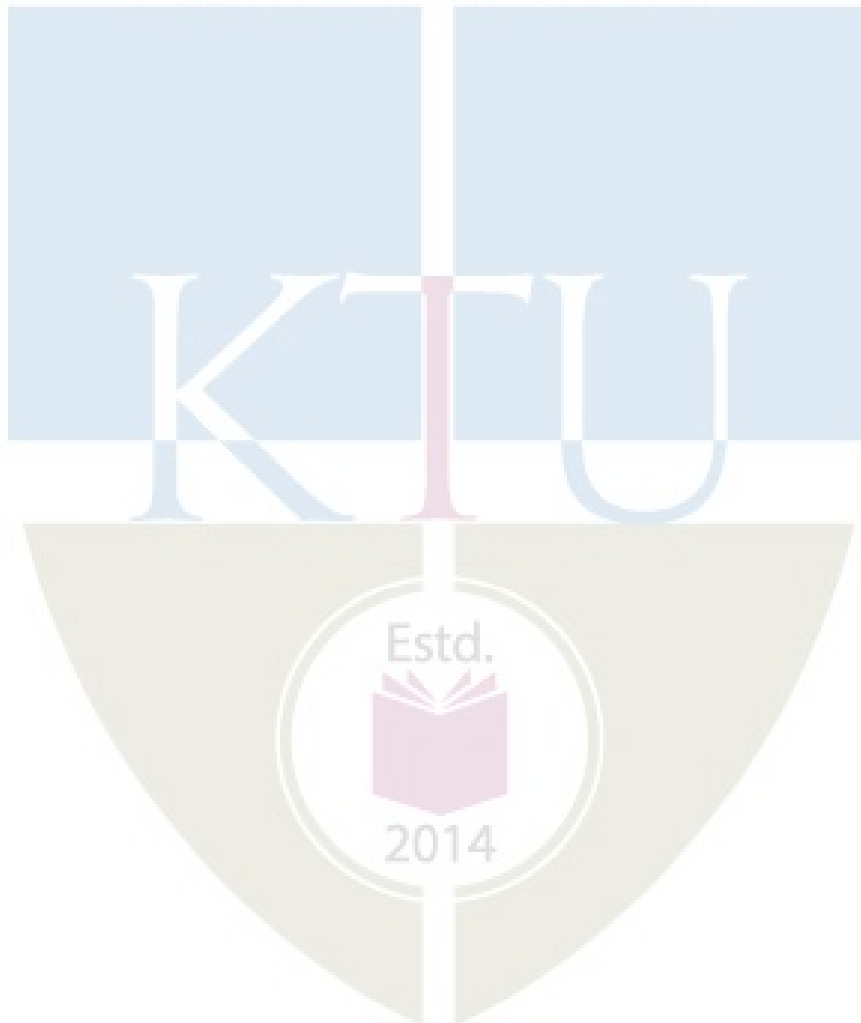

ECT474	ENTREPRENEURSHIP	CATEGORY	L	T	P	CREDIT
		PEC	2	1	0	3

Preamble: The objective of this course is to understand the knowledge of entrepreneurship and apply in the organization.

Prerequisite: Students should have a basic knowledge in management

Course Outcomes: After the completion of the course the student will be able to

CO 1	Discuss the fundamental concepts of entrepreneurship
CO 2	Understand entrepreneurial motivation and motivation theories
CO 3	Analyze types of enterprises and ownership structure
CO 4	Apply project evaluation methods
CO 5	Evaluate enterprise financial strength

Mapping of course outcomes with program outcomes

	PO 1	PO 2	PO 3	PO 4	PO 5	PO 6	PO 7	PO 8	PO 9	PO 10	PO 11	PO 12
CO 1										1	1	
CO 2								2		1		
CO 3										1		
CO 4	2		1		2					1	3	
CO 5	2		1		2					1	3	

Assessment Pattern

Bloom's Category	Continuous Assessment Tests		End Semester Examination
	1	2	
Remember	10	10	10
Understand	20	10	10
Apply	20	10	40
Analyse		10	20
Evaluate		10	20
Create			

Mark distribution

Total Marks	CIE	ESE	ESE Duration
150	50	100	3 hours

Continuous Internal Evaluation Pattern:

Attendance	: 10 marks
Continuous Assessment Test (2 numbers)	: 25 marks
Assignment/Quiz/Course project	: 15 marks

End Semester Examination Pattern: There will be two parts; Part A and Part B. Part A contain 10 questions with 2 questions from each module, having 3 marks for each question. Students should answer all questions. Part B contains 2 questions from each module of which student should answer any one. Each question can have maximum 2 sub-divisions and carry 14 marks.

Course Level Assessment Questions**Course Outcome 1 (CO1):**

1. Explain the Concept of entrepreneur.
2. Explain the characteristics and qualities of entrepreneurs.

Course Outcome 2 (CO2):

1. Describe a few ways to promote innovations in an organization.
2. Discuss the motivational theories.

Course Outcome 3(CO3):

1. Explain the various types of ownerships available to entrepreneurs.
- 2 Describe features of limited companies.

Course Outcome 4 (CO4):

1. Explain the factors influencing project plan.
2. Write a note on IRR.

Course Outcome 5 (CO5):

1. List the sources of finance.
2. Define break-even analysis.

Syllabus

Module I

Entrepreneurship: definition, requirements to be an entrepreneur, entrepreneur and intrapreneur, entrepreneur and manager, growth of entrepreneurship in India, women entrepreneurship, rural and urban entrepreneurship.

Entrepreneurial Motivation: motivating factors, motivation theories-Maslow's need hierarchy theory, McClelland's acquired need theory, government's policy actions towards entrepreneurial motivation, entrepreneurship development programmes.

Module II

Types of Enterprises and Ownership Structure: small scale, medium scale and large scale enterprises, role of small enterprises in economic development; proprietorship, partnership, limited companies and co-operatives: their formation, capital structure and source of finance.

Module III

Institutional Support and Policies: institutional support towards the development of entrepreneurship in India, technical consultancy organizations, Government programs, policies, incentive and institutional networking for enterprise setting, women entrepreneurship development in India, promotional schemes.

Module IV

Projects: identification and selection of projects, project report, contents and formulation, elements of project formulation, project design and network analysis, concept of project evaluation, methods of project evaluation: internal rate of return method and net present value method.

Module V

Management of Enterprises: objectives and functions of management, scientific management, general and strategic management; introduction to human resource management: planning, job analysis, training, recruitment and selection, marketing and organizational dimension of enterprises; enterprise financing, raising and managing capital, shares, debentures, bonds, cost of capital; break-even analysis, balance sheet analysis.

Textbook

1. Ram Chandran, Entrepreneurial Development, Tata McGraw Hill, New Delhi, 2008
2. Saini, J. S. Entrepreneurial Development Programmes and Practices, Deep & Deep Publications, 2012

References

1. Khanka, SS. Entrepreneurial Development, S Chand & Company Ltd. New Delhi, 2007
2. Badhai, B Entrepreneurship for Engineers, Dhanpat Rai & co, 2006
3. Desai, Vasant, 'Project Management and Entrepreneurship', Himalayan Publishing, Mumbai, 2017
4. Gupta, Srinivasan, 'Entrepreneurial Development', S Chand & Sons, New Delhi, 2020
5. Kuratko and Rao, Entrepreneurship, Cengage Learning, 2012

Course Contents and Lecture Schedule

No	TOPIC	No. of Lectures
1	Introduction to Entrepreneurship	
1.1	Entrepreneurship: definition, requirements to be an entrepreneur, entrepreneur and intrapreneur,	1
1.2	Entrepreneur and manager, growth of entrepreneurship in India, women entrepreneurship	1
1.3	Rural and urban entrepreneurship.	1
1.4	Entrepreneurial motivation: motivating factors, motivation theories, Maslow's Need Hierarchy Theory.	2
1.5	McClelland's acquired need theory, government's policy actions towards entrepreneurial motivation.	1
1.6	Entrepreneurship development programmes.	1
2	Types of enterprises and ownership structure	
2.1	Small scale, medium scale and large scale enterprises.	2
2.2	Role of small enterprises in economic development.	1
2.3	Proprietorship, partnership	1
2.4	Limited companies	1
2.5	Co-operatives: their formation, capital structure and source of finance	2
3	Institutional support and policies	
3.1	Institutional support towards the development of entrepreneurship in India	1
3.2	Technical consultancy organizations	1
3.3	Government programs, policies, incentive and institutional networking	2

	for enterprise setting.	
3.4	Women entrepreneurship development in India	1
3.5	Promotional schemes.	1
4	Projects	
4.1	Identification and selection of projects	1
4.2	Project report, contents and formulation.	1
4.3	Elements of project formulation,	1
4.4	Project design and network analysis.	1
4.5	Concept of project evaluation, methods of project evaluation	1
4.6	Internal rate of return method	1
4.7	Net present value method.	1
5	Management of Enterprises	
5.1	Objectives and functions of management, scientific management, general and strategic management.	1
5.2	Introduction to human resource management, planning, job analysis.	1
5.3	Training, recruitment and selection	1
5.4	Marketing and organizational dimension of enterprises.	1
5.5	Enterprise financing, raising and managing capital, shares, debentures bonds, cost of capital	2
5.6	Break- even analysis	1
5.7	Balance sheet analysis.	1

Model Question Paper

APJ ABDUL KALAM TECHNOLOGICAL UNIVERSITY
EIGHTH SEMESTER B.TECH DEGREE EXAMINATION
COURSE CODE: ECT474
COURSE NAME: ENTREPRENEUSHIP

Max. Marks: 100

Duration: 3 Hours

PART A

(Answer **all** questions. Each question carries **3** marks)

- 1 "Entrepreneurs are made or born." Give your views.
- 2 Explain the role of entrepreneurial development programme (EDP)
- 3 Explain the organizational structure of SMEs.
- 4 Explain the various types of ownerships available to entrepreneurs.
- 5 Write a note on Women entrepreneurs.

- 6 Discuss the incentives available for enterprise setting.
- 7 List the factors influencing project plan.
- 8 Discuss the aspects and methods of project appraisal.
- 9 List the job analysis methods.
- 10 Explain raising and managing capital.

(10x3=30 marks)

PART B

(Answer **one** question from each module. Each question carries **14** marks)

Module I

- 11 Explain the characteristics and qualities of entrepreneurs.
- 12 Discuss the Maslow's need hierarchy theory.

Module II

- 13 Explain the role and importance of Small and Medium Enterprises.
- 14 Explain the various types of ownerships available to entrepreneurs. Discuss each form in brief.

Module III

- 15 Explain the role of central Government and state Government in promoting entrepreneurship.
- 16 What is the status of women entrepreneurs in contemporary business? Illustrate with examples.

Module IV

- 17 Explain IRR.
- 18 Explain net present value method.

Module V

- 19 What is working capital? Why is it important for any enterprise? Explain.
- 20 Discuss break- even analysis.

(5x14=70 marks)

APJ ABDUL KALAM
TECHNOLOGICAL
UNIVERSITY

SEMESTER VIII
PROGRAM ELECTIVE IV



ECT416	MODERN COMMUNICATION SYSTEMS	CATEGORY	L	T	P	CREDIT
		PEC	2	1	0	3

Preamble: This course aims to impart knowledge on the basics of modern communication systems and the breakthrough wireless technologies.

Prerequisite: MAT 204 Probability, Random Process and Numerical Methods, ECT 305 Analog and Digital Communication, ECT 306 Information Theory and Coding

Course Outcomes: After the completion of the course the student will be able to

CO1	Explain OFDM, OFDMA and SC-FDMA techniques used in cellular communication
CO2	Discuss the different wireless communication standards for short range communication
CO3	Explain the IoT architecture and various connectivity technologies used in IoT Systems
CO4	Understand the various communication standards for connected autonomous vehicles
CO5	Explain the significance and architecture of software defined radio and cognitive radio

Mapping of course outcomes with program outcomes

	PO 1	PO 2	PO 3	PO 4	PO 5	PO 6	PO 7	PO 8	PO 9	PO 10	PO 11	PO 12
CO1	3	3	3		2							
CO2	3	3	3			3						1
CO3	3	3	3			3						
CO4	3	3	3			3						1
CO5	3	3	3		2							

Assessment Pattern

Bloom's Category	Continuous Assessment Tests		End Semester Examination
	1	2	
Remember	10	10	20
Understand	30	30	60
Apply	10	10	20
Analyse			
Evaluate			
Create			

Mark distribution

Total Marks	CIE	ESE	ESE Duration
150	50	100	3 hours

Continuous Internal Evaluation Pattern:

Attendance	: 10 marks
Continuous Assessment Test (2 numbers)	: 25 marks
Assignment/Quiz/Course project	: 15 marks

End Semester Examination Pattern: There will be two parts; Part A and Part B. Part A contain 10 questions with 2 questions from each module, having 3 marks for each question. Students should answer all questions. Part B contains 2 questions from each module of which student should answer any one. Each question can have maximum 2 sub-divisions and carry 14 marks. Mark patterns are as per the syllabus with 70 % for theory and 30% for logical/numerical problems, derivation and proof.

Course Level Assessment Questions**Course Outcome 1 (CO1):**

1. What is shadowing and how it can be modelled in mobile communication?
2. Explain PAPR in OFDM systems.

Course Outcome 2 (CO2):

1. Compare the physical-layer characteristics of various IEEE 802.11 standards.
2. Explain the characteristics of millimeter wave.

Course Outcome 3 (CO3):

1. Differentiate between WiFi and Bluetooth standards in IoT systems.
2. Explain the salient features of 6LoWPAN.

Course Outcome 4 (CO4):

1. Mention the advantages of 4G/5G LTE standard in vehicular communication.
2. Explain the DSRC standard for vehicular communication.

Course Outcome 5 (CO5):

1. Explain the issues with zero IF receiver architecture for SDR.
2. Discuss the functions of software adaptable network (SAN) in cognitive network.

SYLLABUS

Module	Course contents
I	<p>Module 1: Cellular Communication System</p> <p>Need for Multi carrier system, Basics of Orthogonal Frequency Division Multiplexing (OFDM), Multiple access for OFDM systems, Orthogonal Frequency Division Multiple Access (OFDMA), Single carrier Frequency Division Multiple Access (SC-FDMA). Cellular concept, path loss and shadowing, Doppler shift, Multipath effect, Significance of diversity in wireless communication systems.</p>
II	<p>Module 2: Short Range Communication System</p> <p>Introduction to current wireless technologies, background and current scenario, future wireless network requirements, IEEE 802.11 (Wi-Fi) standards and applications (IEEE 802.11a/b/g/n/ac/ax), HiperLAN technology, WPAN (IEEE 802.15.1, IEEE 802.15.3 & IEEE 802.15.4) and WMAN (IEEE 802.16a - WiMAX), Space time wireless standards, IEEE 802.16 (Wi-Max standard), 3GPP-LTE standard, Millimeter wave characteristics, Channel performance at 60 GHz, Development of millimeter wave standards, Indoor and outdoor applications for millimeter wave communications. 6G Networks – Use Cases and Technologies.</p>
III	<p>Module 3: IoT System</p> <p>Introduction of IoT, characteristics, physical and logical design of IoT, IoT Enabling Technologies – Wireless Sensor networks, Cloud computing. Introduction to IoT, Evolution of IoT, IoT Networking Components. IoT Connectivity Technologies – Zigbee, Wireless HART, RFID, NFC, LoRa, WiFi, Bluetooth. IoT Communication Technologies – Infrastructure Protocols – IPv6, 6LoWPAN, Data Protocols – MQTT, MQTT-SN, CoAP. IoT Case Studies and Future Trends – Agricultural IoT, Vehicular IoT, Healthcare IoT.</p>
IV	<p>Module 4: Intelligent Transport System</p> <p>Introduction to Intelligent Vehicular Communication – Evolution, Vehicular Networks and ITS, Vehicular Communication Standards/ Technologies – DSRC, IEEE 802.11p WAVE, IEEE 1609, IEEE 802.15.7 - Visible Light Communication (VLC), 4G/5G-Device to Device (D2D), 6G Cellular Networks and Connected Autonomous Vehicles, Operational Scenario – Collision Avoidance.</p>
V	<p>Module 5: Software Defined Radio System</p> <p>Software radio concepts, Operating frequency bands, Transmitter and Receiver specifications of SDR, Architecture of SDR, Introduction of cognitive radio,</p>

	significance of cognitive radio and spectrum subleasing, spectrum sharing in cognitive radio, implementation of cognitive radio.
--	--

Text Books

1. Aditya K. Jagannatham, "Principles of Modern Wireless Communication Systems", Tata McGraw Hill, 2016.
2. T.L. Singal, "Wireless Communications", Tata McGraw Hill Education Private Limited, Second Edition, 2011.
3. K. C. Huang, Z. Wang, "Millimeter Wave Communication systems", John Wiley & Sons.
4. Sudip Misra, Anandarup Mukherjee & Arijit Roy. "Introduction to IoT". Cambridge University Press. 2021.
5. George J. Dimitrakopoulos. "Current Technologies in Vehicular Communication", Springer International Publishing, 2017.
6. He, J., Yang, K. and Chen, H.H, "6G Cellular Networks and Connected Autonomous Vehicles", IEEE Network, vol. 35, no. 4, pp. 255 -261, 2020.
7. Walter Tuttlebee, "SDR Enabling Technologies", John Wiley.
8. Huseyin Arslan, "Cognitive Radio, SDR and Adaptive Wireless System", Springer, 2007.

Reference Books

1. Dipankar Raychaudhuri, Mario Gerla, "Emerging Wireless Technologies and the Future Mobile Internet", Cambridge University Press, 2011.
2. Arshdeep Bahga, A., & Vijay Madisetti V. "Internet of Things: A hands-on approach". Vpt., 2014.
3. Paul, A., Chilamkurti, N., Daniel, A. and Rho, S. "Intelligent vehicular networks and communications: fundamentals, architectures and solutions". Elsevier, 2016.
4. Peter B. Kenington, 'RF and baseband techniques for software defined radio', Artech House Mobile Communication, 2005.

Course content and Lecture plan

No	TOPIC	No of Lectures
MODULE 1		
1.1	Need for Multi carrier system	1
1.2	Basics of Orthogonal Frequency Division Multiplexing (OFDM), Multiple access for OFDM systems	2
1.3	Orthogonal Frequency Division Multiple Access (OFDMA)	1
1.4	Single carrier Frequency Division Multiple Access (SC- FDMA)	1
1.5	Cellular concept, path loss and shadowing, doppler shift,	2

	Multipath effect	
1.6	Significance of diversity in wireless communication systems	1
MODULE II		
2.1	Introduction to current wireless technologies, background and current scenario, future wireless network requirements	1
2.2	IEEE 802.11 (Wi-Fi) standards and applications (IEEE 802.11a/b/g/n/ac/ax)	1
2.3	HiperLAN technology	1
2.4	WPAN (IEEE 802.15.1, IEEE 802.15.3 & IEEE 802.15.4)	2
2.5	WMAN (IEEE 802.16a - WiMAX), 3GPP-LTE standard	1
2.6	Millimeter wave characteristics, Channel performance at 60 GHz, Development of millimeter wave standards	2
2.7	Indoor and outdoor applications for millimeter wave communications, 6G Networks – Use Cases and Technologies.	1
MODULE III		
3.1	Introduction to IoT, Evolution of IoT, IoT Networking Components	1
3.2	IoT Connectivity Technologies – Zigbee, Wireless HART, RFID, NFC, LoRa, WiFi, Bluetooth	2
3.3	IoT Communication Technologies – Infrastructure Protocols – IPv6, 6LoWPAN	2
3.4	Data Protocols – MQTT, MQTT-SN, CoAP	1
3.5	IoT Case Studies and Future Trends – Agricultural IoT, Vehicular IoT, Healthcare IoT	1
MODULE IV		
4.1	Introduction to Intelligent Vehicular Communication – Evolution, Vehicular Networks and ITS	1
4.2	Vehicular Communication Standards/ Technologies – DSRC, IEEE 802.11p WAVE, IEEE 1609, IEEE 802.15.7 - Visible Light Communication (VLC)	2
4.3	4G/5G-Device to Device (D2D), 6G Cellular Networks and Connected Autonomous Vehicles	2
4.4	Operational Scenario – Collision Avoidance	1
MODULE V		
5.1	Software radio concepts, Operating frequency bands, Transmitter and Receiver specifications of SDR	1
5.2	Architecture of SDR	1
5.3	Introduction of cognitive radio, significance of cognitive radio and spectrum subleasing, spectrum sharing in cognitive radio	2
5.4	Implementation of cognitive radio	1

Model Question Paper**APJ ABDUL KALAM TECHNOLOGICAL UNIVERSITY****EIGHTH SEMESTER B. TECH DEGREE EXAMINATION****Course Code: ECT416****Course Name: MODERN COMMUNICATION SYSTEMS**

Max. Marks: 100

Duration: 3 Hours

PART A		
Answer all questions, each carries 3 marks		
1.	Explain inter-carrier interference in OFDM systems.	3
2	Determine the maximum speed of a vehicle in a mobile communication system experiencing a maximum Doppler frequency shift of 70 Hz and a frequency of transmission 900 MHz.	3
3	Write the physical layer specifications of IEEE 802.16 WMAN technology.	3
4	What are the main challenges in utilizing a 60 GHz channel for millimeter wave communication?	3
5	Describe the various IoT networking components?	3
6	What is LoRaWAN? How is it different from LoRa?	3
7	What are the advantages of VLC standard over other communication standards in vehicular communication?	3
8	Mention the main limitations of IEEE 802.11p standard compared to cellular communication in connected autonomous vehicles.	3
9	List the main SDR transmitter specifications?	3
10	Describe spectrum subleasing and sharing in cognitive radio.	3
PART B		
Answer any one full question from each module carries 14 marks.		
MODULE 1		
11	a. What is the need for adding cyclic prefix to the OFDM sequence.	4
	b. Draw and explain the SC-FDMA transmitter and receiver schematic.	10
OR		

12	a. Briefly explain free space propagation model in wireless communication.	8
	b. A mobile subscriber travels at a uniform speed of 60 km/h. Compute the time between fades if the mobile uses (i) a cellphone operating at 900 MHz (ii) a PCS phone operating at 1900 MHz Comment on the results obtained.	6
	MODULE II	
13	a. Write any three indoor and outdoor applications of millimeter wave communication.	6
	b. Compare the three different IEEE 802.15 WPAN standards.	8
	OR	
14	a. Briefly explain the different elements to be considered while considering an existing backhaul network to support a millimeter wave network.	8
	b. Discuss the advantages and disadvantages of WLAN technology.	6
	MODULE III	
15	a. Explain the principle of operation of MQTT data protocol employed in IoT networks.	6
	b. Briefly describe the architecture of healthcare IoT system.	8
	OR	
16	a. Briefly explain Zigbee protocol stack used in IoT Systems.	8
	b. Discuss the salient features of the CoAP protocol.	6
	MODULE IV	
17	a. Explain the key components of connected autonomous vehicles in 6G communications with the help of a diagram.	6
	b. Describe how collision avoidance can be achieved through vehicular communication.	8
	OR	
18	a. With the help of a diagram, explain the architecture of ITS system utilizing VLC standard for V2X communication.	9
	b. Briefly explain IEEE 1609 standard used in vehicular communication.	5
	MODULE V	
19	a. Briefly explain the low IF receiver architecture for SDR.	9
	b. Define cognitive radio and explain its significance.	5
	OR	

20	a. Describe software defined radio with the help of functional block diagram.	7
	b. Discuss about the implementation of cognitive network.	7

Simulation Assignments

The following simulation assignments can be done with Python/ MATLAB/ SCILAB/ LabVIEW.

1. Peak to Average Power Ratio (PAPR) of OFDM and SC-FDMA system

- Realize the block diagram of OFDMA transmitter system shown in Fig 7.8 in page 240 in *Principles of Modern Wireless Communication Systems*.
- Create a random bit vector of arbitrary length. Realize the OFDM transmitter by mapping the message bits into a sequence of QPSK symbols and convert it into N parallel streams.
- Realize the multicarrier modulation by computing IFFT.
- Implement parallel to serial converter and add cyclic prefix to generate the OFDM signal.
- Compute the PAPR of OFDM signal and plot its complementary CDF (CCDF).
- Realize the block diagram of SC-FDMA transmitter system shown in Fig 7.18 in page 260 in *Principles of Modern Wireless Communication Systems*.
- To generate SC-FDMA signal, repeat the steps followed in OFDM transmitter with the addition of 2 blocks FFT computation and subcarrier mapping before IFFT computation.
- Compute the PAPR of SC-FDMA signal and plot its CCDF.
- Compare both CCDF graphs and observe the reduction in PAPR for SC-FDMA system.

2. Computation of Free space path loss and received power

- Input a suitable signal frequency, f and distance between the transmitter and receiver, d .
- Compute the free space propagation path loss, L_p using Eq. 3.13 and 3.14 in page 71 in *Wireless Communications*, assuming transmitter and receiver antenna gain as unity.
- Study the effect of antenna gain on path loss by computing path loss, with non-unity transmitter, G_t and receiver antenna gain, G_r .
- Find the received power, P_r for a particular transmitter power, P_t , G_t , G_r and L_p using Eq. 3.12 in page 71 in *Wireless Communications*.
- Repeat the above step for different values of P_t , G_t , G_r and L_p . Observe the variation in received power

3. SDR Receiver

- Study the various dynamic range issues of SDR receiver, based on the receiver design considerations given in Section 2.2.1 in page 29 – 31 in *SDR Enabling Technologies*.
- Compute third order intercept (TOI) using Eq. 1 in page 36 in *SDR Enabling Technologies*, by giving suitable input parameters.

- Compute overall noise figure of cascade of amplifiers and its worst-case TOI using Eq. 2 and 3 in page 36 in *SDR Enabling Technologies*.
- Study the dynamic range of SDR receiver by calculating spurious free dynamic range (SFDR) using Eq. 5 in page 40 in *SDR Enabling Technologies*.

APJ ABDUL KALAM
TECHNOLOGICAL
UNIVERSITY

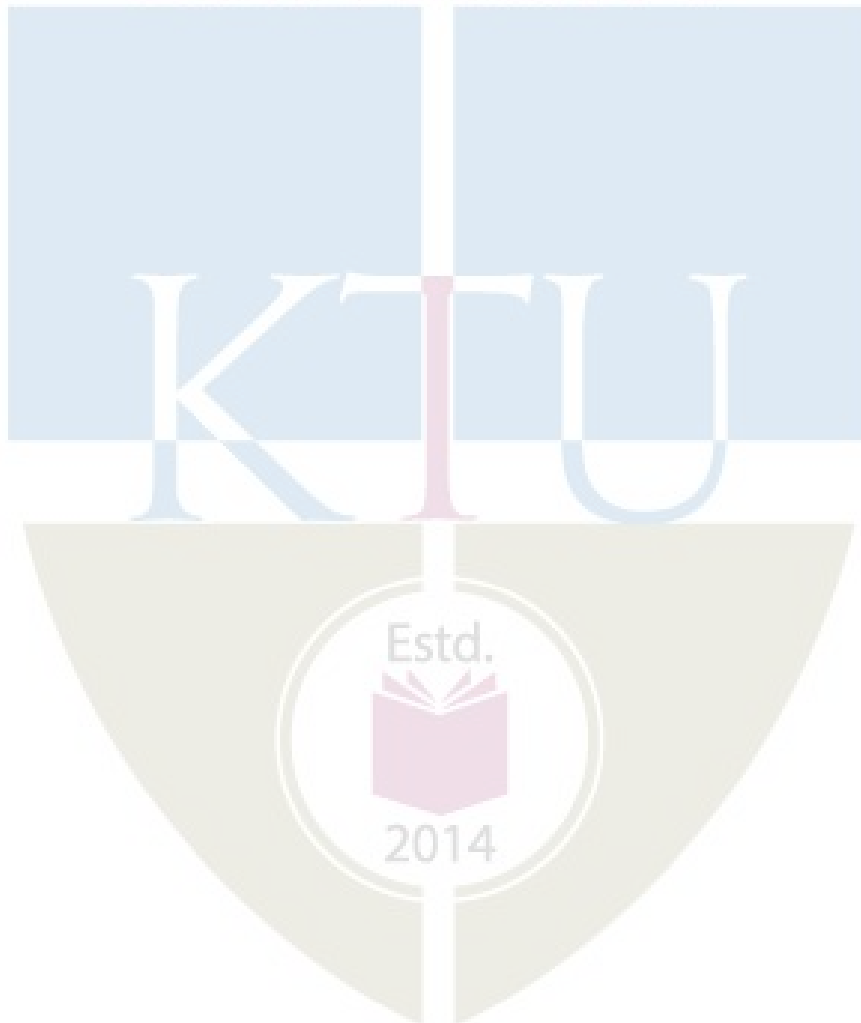

ECT426	REAL TIME OPERATING SYSTEMS	CATEGORY	L	T	P	CREDIT
		PEC	2	1	0	

Prerequisite: ECT 206 computer Architecture and Microcontrollers

Course objectives: The objectives of this course are to:

1. Identify the basics of general operating systems.
2. Understand the structure and the scheduling operations performed by the operating systems.
3. Introduce Real Time Operating Systems, its basic structure, building blocks and various operations.
4. Summarize the different scheduling algorithms used in RTOS.
5. Identify the different applications of real time operating systems

Course Outcomes: After the completion of the course the student will be able to

CO1 K2	Summarize the functions and structure of general-purpose operating systems.
CO2 K3	Use different scheduling algorithms on processes and threads.
CO3 K2	Interpret a real time operating system along with its synchronization, communication and interrupt handling tools.
CO4 K4	Illustrate task constraints and analyze the different scheduling algorithms on tasks.
CO5 K3	Illustrate the applications of real time operating systems.

Mapping of course outcomes with program outcomes

	PO 1	PO 2	PO 3	PO 4	PO 5	PO 6	PO 7	PO 8	PO 9	PO 10	PO 11	PO 12
CO 1		3										
CO 2	2	3										2
CO 3	2	3					2					2
CO 4	2	2					2					2
CO 5	2	3	2				3				2	2

Assessment Pattern

Bloom's Category		Continuous Assessment Tests		End Semester Examination
		1	2	
Remember	K1	10	10	20
Understand	K2	25	25	50
Apply	K3	10	10	20
Analyze	K4	5	5	10
Evaluate				
Create				

Mark distribution:

Total Marks	CIE	ESE	ESE Duration
150	50	100	3 hours

Continuous Internal Evaluation Pattern:

Attendance: 10 marks

Continuous Assessment Test (2 numbers): 25 marks

Assignment/Quiz/Case study: 15 marks

End Semester Examination Pattern: There will be two parts; Part A and Part B. Part A contain 10 questions with 2 questions from each module, having 3 marks for each question. Students should answer all questions. Part B contains 2 questions from each module of which student should answer any one. Each question can have maximum 2 sub-divisions and carry 14 marks.

Course Level Assessment Questions:**Course Outcome 1 (CO1):**

1. List the functions of operating systems.
2. Describe the importance of Kernel in operating system functions.
3. Explain monolithic and layered architecture of operating systems.
4. Draw the process state diagram and explain.

Course Outcome 2 (CO2):

1. Schedule the following processes with FCFS and Round Robin algorithm for a time of 2mS. Assuming all the processes arrives at time zero. Also state the performance of the system.

Process	Burst time
P1	4
P2	5
P3	2
P4	3

2. Compare user level threads and Kernel level threads.
3. Discuss the different types of multiprocessor scheduling operations.
4. Explain the possible scheduling of user level threads with a 50mS process quantum and threads that run 5mS per CPU time.

Course Outcome 3 (CO3):

1. Explain the different types of semaphores used for process synchronization.
2. Explain how the priority inversion problem in RTOS is solved.
3. Draw the structure and explain the working of a message queue.
4. Differentiate between exceptions and interrupts.
5. What are the different classifications of exceptions?

Course Outcome 4 (CO4):

1. Explain the different timing constraints of a real time task.
2. Illustrate Jackson's algorithm with an example.
3. Explain EDF algorithm with precedence constraints.
4. Verify the schedulability under EDF and construct the schedule of the following task set

	C_i	D_i	T_i
τ_1	2	5	6
τ_2	2	4	8
τ_3	4	8	12

5. Draw the state transition diagram of a real time kernel.

Course Outcome 5 (CO5):

1. Illustrate the implementation of a real time system with an example,
2. With a block schematic explain the real time control system used in an adaptive cruise control.

Syllabus

Module	Course contents	Hours
I	Operating system: Types, Objectives and functions , Kernel, Process - States, Process Control Block, Operations on processes.	6
II	Process Scheduling: FCFS, SJF, Priority, Round-Robin, Multilevel Queue and Multilevel Feedback Queue Scheduling. Thread: Structure. User and kernel level threads, multi-threading models, multiprocessor scheduling.	7
III	Real Time Operating Systems: Structure and characteristics of Real Time Systems, Task: Task states, Task synchronization -Semaphores- types, Inter task communication mechanisms: message queues, pipes, event registers, signals, Exceptions and interrupt handling.	8
IV	Task constraints, Task scheduling: Aperiodic task scheduling: EDD, EDF, LDF, EDF with precedence constraints. Periodic task scheduling: Rate monotonic and Deadline monotonic, Real time Kernel- Structure, State transition diagram, Kernel primitives.	8
V	Features of FreeRTOS and Linux Commercial real time operating systems: PSOS, VRTX, RT Linux- Features and application only. Case study of (Kernel design, threads and task scheduling) RTOS: MicroC/OS-II. RTOS control system used in real life applications - in adaptive cruise control.	6

Text Books

1. Abraham Silberschatz- 'Operating System Principles': Wiley India, 7th edition, 2011
2. William Stallings –'Operating systems- Internals and design principles', Prentice Hall, 7th edition, 2011
3. Qing Li – 'Real-Time Concepts for Embedded Systems ', CMP Books, 2013
4. Giorgio C. Buttazzo, -'HARD REAL-TIME COMPUTING SYSTEMS Predictable Scheduling Algorithms and Applications', Kluwer Academic Publishers.

Reference Books:

1. Tanenbaum -'Modern Operating Systems' ,Pearson Edition, 3/e, 2007.
2. Jean J Labrosse , 'Micro C/OS-II, The Real Time Kernel' , CMP Books, 2011
3. Rajib Mall, 'Real-Time Systems: Theory and Practice ' , 2008.
4. David E. Simon 'An Embedded Software Primer', Pearson 2012
5. Raj Kamal, 'Embedded Systems – Architecture, Programming and Design', Tata McGraw Hill

Course content and Lecture plan

No	TOPIC	No of Lectures
MODULE 1		
1.1	Introduction to Operating system- Types, Objective and functions	2
1.2	Kernel - Importance and functions	2
1.3	Process - States, Process Control Block, Operations on processes	2
MODULE II		
2.1	Process Scheduling: FCFS, SJF, Priority, Round-Robin	2
2.2	Multilevel Queue and Multilevel Feedback Queue Scheduling	2
2.3	Thread- Structure. User and kernel level threads, Multi-threading models	2
2.4	Multiprocessor scheduling	1
MODULE III		
3.1	Real Time Operating Systems: Structure and characteristics of Real Time Systems	1
3.2	Task: Task states	1
3.3	Task synchronization -Semaphores- types	2
3.4	Inter task communication mechanisms: message queues, pipes, event registers, signals	2
3.5	Exceptions and interrupt handling	2
MODULE IV		
4.1	Task constraints	1
4.2	Task scheduling: Aperiodic task scheduling: EDD, EDF, LDF, EDF with precedence constraints	3
4.3	Periodic task scheduling: Rate monotonic, Deadline monotonic	2
4.4	Real time Kernel- Structure, State transition diagram, Kernel primitives	2
MODULE V		
5.1	Features of FreeRTOS and Linux	1
5.2	Commercial real time operating systems: PSOS, VRTX, RT Linux- Features and application only.	2
5.3	Case study of RTOS: MicroC/OS-II real time operating systems.	2
5.4	RTOS control system used in real life applications - in adaptive cruise control.	1

Model Question Paper**APJ ABDUL KALAM TECHNOLOGICAL UNIVERSITY**

VIII SEMESTER B. TECH DEGREE EXAMINATION

Course Code: ECT426

Course Name: REAL TIME OPERATING SYSTEMS

Max. Marks: 100

Duration: 3 Hours

PART A		
Answer all questions, each carries 3 marks		
1.	List any six functions of an operating system.	3
2.	Differentiate microkernel and exokernel structures of operating systems.	3
3.	Explain the different operations on processes.	3
4.	Explain the differences between Pre-emptive and Non pre-emptive scheduling policies.	3
5.	Draw the state diagram of RTOS queue and explain.	3
6.	What you mean by priority inversion in real time systems? How the operating system manages this issue?	3
7.	Explain EDD algorithm with an example.	3
8.	Explain the task control block of a real time kernel.	3
9.	List the features of FreeRTOS.	3
10.	Illustrate the threads in MicroC/OS-II operating system.	3
PART B		
Answer any one full question from each module, Each question carries 14 marks.		
MODULE 1		
11	a. Explain the functions of operating system as Resource Manager.	7
	b. Describe the structure of a Process Control Block	7
OR		
12	a. Explain the monolithic and microkernel architectures of OS kernel.	7
	b. Draw the process state diagram and explain the different states.	7
MODULE II		

13	a. Explain the Shortest Remaining Time First algorithm with a suitable example.	7																		
	b. Schedule the given 5 processes with Round Robin scheduling.	7																		
	<table border="1"> <thead> <tr> <th>Process ID</th> <th>Arrival Time</th> <th>Burst Time</th> </tr> </thead> <tbody> <tr> <td>P1</td> <td>0</td> <td>5</td> </tr> <tr> <td>P2</td> <td>1</td> <td>3</td> </tr> <tr> <td>P3</td> <td>2</td> <td>1</td> </tr> <tr> <td>P4</td> <td>3</td> <td>2</td> </tr> <tr> <td>P5</td> <td>4</td> <td>3</td> </tr> </tbody> </table> <p>Draw the Gantt chart and calculate the average waiting time and turn-around time for these processes if time quantum is 2 units,</p>	Process ID	Arrival Time	Burst Time	P1	0	5	P2	1	3	P3	2	1	P4	3	2	P5	4	3	
Process ID	Arrival Time	Burst Time																		
P1	0	5																		
P2	1	3																		
P3	2	1																		
P4	3	2																		
P5	4	3																		
	OR																			
14	Compare FCFS and Round -Robin scheduling algorithms	7																		
	b. Explain thread scheduling algorithms used in operating systems in detail.	7																		
	MODULE III																			
15	a. Draw the structure of a real time operating system and explain.	7																		
	b. Differentiate between exceptions and interrupts. What are the different classifications of exceptions	7																		
	OR																			
16	a. Explain how synchronization is achieved between different tasks in a real time operating system	7																		
	b. Describe any two inter task communication mechanisms in a real time operating systems.	7																		
	MODULE IV																			
17	a. Illustrate Horn's algorithm with an example.	7																		
	b. Explain EDF algorithm with precedence constraints.	7																		
	OR																			
18	a. Explain the precedence constraints of a real time task.	7																		

	<p>b. Verify the schedulability and construct the scheduling according to the rate monotonic algorithm for the following set of periodic tasks r_1, r_2 and r_3.</p> <table border="1" data-bbox="443 228 762 427"> <thead> <tr> <th></th> <th>Ci</th> <th>Ti</th> </tr> </thead> <tbody> <tr> <td>r_1</td> <td>3</td> <td>5</td> </tr> <tr> <td>r_2</td> <td>1</td> <td>8</td> </tr> <tr> <td>r_3</td> <td>1</td> <td>10</td> </tr> </tbody> </table> <p>Where Ci and Ti are the computation time activation period of the task.</p>		Ci	Ti	r_1	3	5	r_2	1	8	r_3	1	10	7
	Ci	Ti												
r_1	3	5												
r_2	1	8												
r_3	1	10												
MODULE V														
19	a. Illustrate the implementation of a real time system with an example,	7												
	b. Explain the inter-process communication techniques used in Micro C/OS-II	7												
OR														
20	a. Compare the features of PSOS, VRTX and RT Linux	7												
	b. Prepare suitable requirements table for an RTOS control system used in adaptive cruise control.	7												

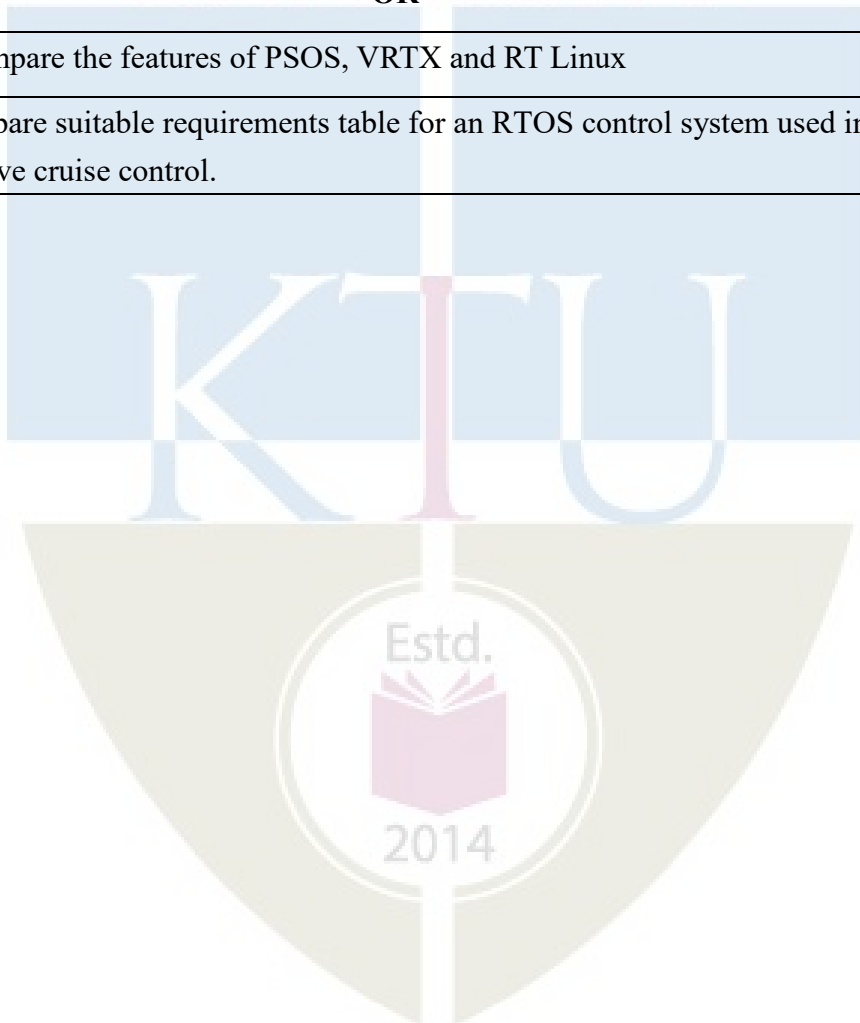

Assessment Pattern

Bloom's Category		Continuous Assessment Tests		End Semester Examination
		1	2	
Remember	K1	10	10	20
Understand	K2	30	30	60
Apply	K3	10	10	20
Analyse				
Evaluate				
Create				

Mark distribution

Total Marks	CIE	ESE	ESE Duration
150	50	100	3 hours

Continuous Internal Evaluation Pattern:

Attendance	: 10 marks
Continuous Assessment Test (2 numbers)	: 25 marks
Assignment/Quiz/Course project	: 15 marks

End Semester Examination Pattern: There will be two parts; Part A and Part B. Part A contain 10 questions with 2 questions from each module, having 3 marks for each question. Students should answer all questions. Part B contains 2 questions from each module of which student should answer any one. Each question can have maximum 2 sub-divisions and carry 14 marks. Mark patterns are as per the syllabus with 70 % for theory and 30% for logical/numerical problems, derivation and proof.

Course Level Assessment Questions**Course Outcome 1 (CO1):** Adaptive systems

1. Describe the characteristics and applications of adaptive signal processing
2. Describe open and closed loop adaptation

Course Outcome 2 (CO2): Searching performance surface-stability and rate of convergence

1. Compare Newton's & Steepest-descent methods in terms of speed adaptation and mis-adjustment.
2. Discuss about role of Learning curves.

Course Outcome 3 (CO3): LMS algorithm

1. Discuss Correlation properties of lattice Filter

2. Derive LMS adaptive algorithm

Course Outcome 4 (CO4): Kalman filtering, Applications-adaptive modeling and system identification

1. Discuss Kalman filtering.
2. Explain how adaptive filters can be used for single input system identification

Course Outcome 5 (CO5): Inverse adaptive modeling

1. Describe the two types of inverse modelling approaches.
2. Derive the least-square solution to inverse modelling problem

Syllabus

Module	Course contents	Hours
I	Adaptive systems- Definitions and characteristics - applications – properties examples - adaptive linear combiner input signal and weight vectors - performance function-gradient and minimum mean square error - introduction to filtering- smoothing and prediction - linear optimum filtering-orthogonality - Wiener – Hopf equation-performance surface	8
II	Searching performance surface-stability and rate of convergence: Learning curve gradient search - Newton's method - method of steepest descent - comparison - Gradient estimation - performance penalty - variance - excess MSE and time constants – mis adjustments	6
III	LMS algorithm, convergence of weight vector: LMS/Newton algorithm - properties - sequential regression algorithm - adaptive recursive filters - random-search algorithms - lattice structure - adaptive filters with orthogonal signals.	7
IV	Kalman filters-recursive minimum mean square estimation for scalar random variable. Applications-adaptive modeling and system identification: Multipath communication channel, geophysical exploration, Kalman filter as the unifying basis for RLS filters.	7
V	Inverse adaptive modeling: Equalization, and deconvolution adaptive equalization of telephone channels-adapting poles and zeros for IIR digital filter synthesis	7

Text Book:

1. Bernard Widrow and Samuel D. Stearns, —Adaptive Signal Processing, Person Education, 1985.
2. Mons H Hays -Statistical Digital Signal Processing and Modeling -Wiley Publications, 2006.

Reference Books:

1. Simon Haykin, —Adaptive Filter Theory, Pearson Education, 2003.
2. John R. Treichler, C. Richard Johnson, Michael G. Larimore, —Theory and Design of Adaptive Filters, Prentice-Hall of India, 2002.
3. John G. Proakis, Dimitris G. Manolokis, “Digital Signal Processing”, Prentice Hall of India, New Delhi, 2005
4. S. Thomas Alexander, “Adaptive Signal Processing - Theory and Application”, Springer-Verlag.
5. D. G. Manolokis, V. K. Ingle and S. M. Kogar, “Statistical and Adaptive Signal Processing”, Mc GrawHill International Edition, 2000.

Course content and Lecture plan

No	TOPIC	No of Lectures
MODULE 1		
1.1	Adaptive systems- characteristics - applications – properties examples	1
1.2	Adaptive linear combiner, input signal and weight vectors performance function-gradient and minimum mean square error	2
1.3	introduction to filtering- smoothing and prediction linear optimum filtering- linear optimum filtering-orthogonality -	3
1.4	Wiener – Hopf equation-performance surface	2
MODULE II		
2.1	Searching performance surface-stability and rate of convergence:	1
2.2	Learning curve gradient search, Newton's method	1
2.3	Method of steepest descent	2
2.4	Gradient estimation	1
2.5	Performance penalty - variance - excess MSE and time constants – mis-adjustments	1
MODULE III		
3.1	LMS algorithm, convergence of weight vector	2
3.2	Newton algorithm - properties	1
3.3	sequential regression algorithm RLS	1
3.4	adaptive recursive filters - random-search algorithms	1
3.5	lattice structure - adaptive filters with orthogonal signals	2
MODULE IV		
4.1	Kalman filters-recursive minimum mean square estimation for scalar random variable.	3
4.2	adaptive modeling and system identification	1
4.3	Multipath communication channel	1
4.4	Geophysical exploration	1
4.5	Kalman filter as the unifying basis for RLS filters.	1

MODULE V		
5.1	Inverse adaptive modeling:	1
5.2	Equalization, and deconvolution	2
5.3	adaptive equalization of telephone channels, Echo, Noise Cancellation.	2
5.4	adapting poles and zeros for IIR digital filter synthesis	2

Model Question Paper

APJ ABDUL KALAM TECHNOLOGICAL UNIVERSITY

EIGHTH SEMESTER B.TECH DEGREE EXAMINATION, (Model Question Paper)

Course Code: ECT436

Course Name: ADAPTIVE SIGNAL PROCESSING

Max. Marks: 100

Duration: 3 Hours

PART A		
Answer all questions, each carries 3 marks		
1	Explain the structure of an Adaptive Linear Combiner.	3
2	Describe the characteristics of an Adaptive System	3
3	Which are the three basic forms of estimation	3
4	What is the minimum mean-square error produced by this Wiener filter	3
5	What is Performance Penalty	3
6	Give a note on stability and rate of convergence	3
7	Propose an adaptive modelling for a multipath channel.	3
8	Explain the application of adaptive modelling	3
9	Discuss deconvolution in inverse adaptive modelling	3
10	Explain types of Adaptive Inverse Systems	3
PART B		
Answer any one full question from each module carries 14 marks.		
MODULE 1		
11	Adaptive systems are nonlinear, Justify. Suppose in an adaptive-filtering environment, where input signal, $x_n = \sin(2\pi n/N)$ and Desired signal, $d_n = 2\cos(2\pi n/N)$ sampled sinusoids with same frequency and N samples per cycle ($N > 2$). Calculate R, P, ξ , W^* , ξ_{\min}	8

	b. Derive the expression for gradient and minimum Mean Square Error with 2-Dimensional Performance surface plots.	6
	OR	
12	a. Given a quadratic MSE function for the Wiener filter: $J = 40 - 20W + 10W^2$, Use the steepest descent method with an initial guess as $w_0=0$ and $\mu=0.04$ to find the optimal solution for W^* and determine ξ_{min} by iterating three times.	7
	b. Derive augmented Wiener-Hopf equation for forward prediction.	7
	MODULE II	
13	a. Explain about Gradient Search methods.	7
	b. Discuss about Stability and Rate of convergence Gradient Searching Algorithm	7
	OR	
14	a. Compare Newton's & Steepest-descent methods in terms of speed adaptation and mis-adjustment.	7
	b. Discuss about role of Learning curves	7
	MODULE III	
15	a. Derive LMS adaptive algorithm.	8
	b. Compare the LMS and the RLS algorithm.	6
	OR	
16	a. Prove Correlation properties of lattice Filter.	7
	b. Discuss sequential regression algorithm	7
	MODULE IV	
17	a. Discuss recursive minimum mean square estimation for scalar random variable using Kalman filter.	7
	b. Explain how adaptive filters can be used for single input system identification	7
	OR	
18	a. Illustrate how adaptive filters are used to measure earth's impulse response.	7
	b. Justify the statement 'Kalman filter are the unifying basis for RLS filters' with necessary mathematical equations.	7

MODULE V		
19	a. Describe the two types of inverse modelling approaches.	7
	b. Derive the least-square solution to inverse modelling problem.	7
OR		
20	Write a short note on adaptive noise cancelling. Consider the noise canceller, Assume $v(n)=Cr(n)$. Determine the best value of W^* that minimise mean square error $E[e^2(n)]$.	10
	b. Explain how poles and zeros can be adapted for IIR filter synthesis.	5

Simulation Assignments (Using MATLAB/Python)

- I. Simulate Normalized LMS algorithm and compare its performance with LMS.
- II. Simulate RLS algorithm and compare its performance with LMS and NLMS.
- III.
 - (a) Generate the data for LMS algorithm using the model $H(z) = (z - 0.8)(z + 0.7) / \{(z - 0.9)(z + 0.8)(z + 65)\}$ (Necessary assumptions can be made)
 - (b) Get an estimate of signal energy for the above data, and using this estimate determine range for μ . Select two values for μ in this range.
 - (c) Run the LMS algorithm in predictive mode for the data you have generated and for the two choices of μ .
 - (d) Do a validation test. You should use the following for the purpose of comparison
 - (i) Learning curve (i.e. Mean square error curve)
 - (ii) Convergent values of $W(n)$
 - (iii) Whiteness of error
 Comment on which choice of μ gives better results, and why.

ECT446	MICROWAVE DEVICES AND CIRCUITS	CATEGORY	L	T	P	CREDIT
		PEC	2	1	0	3

Preamble: This course aims to understand with active and passive microwave semiconductor devices, components, microwave sources and amplifiers used in microwave communication systems, analysis of microwave networks and microwave integrated circuits.

Prerequisite: ECT 401 MICROWAVE AND ANTENNAS

Course Outcomes: After the completion of the course the student will be able to:

CO1 K2	Understand the limitation of conventional solid state devices at Microwave, Gunn – effect diodes, Microwave generation and amplification, IMPATT and TRAPATT diodes
CO2 K3	Design of Bipolar transistors, MESFET, Microwave amplifiers and oscillators
CO3 K3	Analysis of Microwave Network Analysis and the corresponding signal flow graphs
CO4 K3	Design of Microwave filters, Filter design by image parameter method, Filter transformation and implementation
CO5 K2	Understand different MICs, Distributed and lumped elements of integrated circuits, Diode control devices.

Mapping of course outcomes with program outcomes:

	PO1	PO2	PO3	PO4	PO5	PO6	PO7	PO8	PO9	PO10	PO11	PO12
CO1	3	3	2									2
CO2	3	3	3									2
CO3	3	3	3									2
CO4	3	3	3									2
CO5	3	3	2									2

Assessment Pattern:

Bloom's Category	Continuous Assessment Tests		End Semester Examination
	1	2	
Remember			
Understand	20	20	40
Apply	30	30	60
Analyse			
Evaluate			
Create			

Mark distribution:

Total Marks	CIE	ESE	ESE Duration
150	50	100	3Hrs

Continuous Internal Evaluation Pattern:

Attendance	: 10 marks
Continuous Assessment Test (2 numbers)	: 25 marks
Assignment/Quiz/Course project	: 15 marks

End Semester Examination Pattern**Maximum Marks: 100****Time: 3 hours**

There will be two parts; Part A and Part B. Part A contain 10 questions with 2 questions from each module, having 3 marks for each question. Students should answer all questions. Part B contains 2 questions from each module of which student should answer any one. Each question can have maximum 2 subdivisions and carry 14 marks.

Course Level Assessment Questions.**Course Outcome 1 (CO1):**

1. Explain Ridley – Watkins-Hilsum theory.
2. Explain in detail Various modes of operation of Gunn Oscillators.

Course Outcome 2 (CO2):

1. Explain GaAs MESFET with structure and principle of operation? Why GaAs MESFETs are preferred over Si MESFETs.
2. Derive the expression for available power gain of microwave amplifier.

Course Outcome 3 (CO3):

1. Explain the importance of impedance matching or tuning.
2. Evaluate the ABCD matrix coefficient computation of a transmission line section with characteristic impedance ' Z_0 ' propagation constant ' β ' and length ' l '.

Course Outcome 4 (CO4):

1. Design a low-pass composite filter with a cut-off frequency of 2MHz and impedances of 75Ω . Place the infinite attenuation pole at 2.05MHz.
2. With neat circuit explain the Design procedure of an m-derived LPF section and plot the frequency response.

Course Outcome 5 (CO5):

1. Explain the configuration of Planar capacitor film
2. Discuss Strip line in planar transmission and also find the Quality factor.

3. Explain the frequency characteristics of single layer square inductor.

Syllabus

Module	Course contents	Hours
I	Introduction, Characteristic, features of microwaves, Limitation of conventional solid state devices at Microwave. Gunn diodes – Gunn effect, Ridley – Watkins-Hilsum theory, Modes of operation, Limited space – Charge accumulation (LSA) mode of Gunn diode. Microwave generation and amplification. Structure, Operation, Power output and efficiency of IMPATT and TRAPATT diodes	6
II	Bipolar transistors – biasing, FET – biasing, MESFET – Structure, Operation. Microwave amplifiers and oscillators – Amplifiers – Gain and stability, Single stage transistor amplifier design. Oscillator design – One port negative resistance oscillators.	8
III	Microwave Network Analysis – Equivalent voltages and currents, Impedance and Admittance matrices, Scattering matrix, The transmission matrix. Signal flow graphs. Impedance matching and tuning – Matching with lumped elements, Single stub tuning, Double stub tuning. Quarter wave transformer, Theory of small reflections.	6
IV	Microwave filters – Periodic structures – Analysis of infinite periodic structures and terminated periodic structures Filter design by image parameter method – Constant k, m-derived and composite. Filter design by insertion loss method. Filter transformation and implementation.	7
V	Introduction to MICs:-Technology of hybrid MICs, monolithic MICs. Comparison of both MICs. Planar transmission lines such as strip line, microstrip line, and slot line. Distributed and lumped elements of integrated circuits - capacitors, inductors, resistors, terminations, attenuators, resonators and discontinuities. Diode control devices – switches, attenuators, limiters. Diode phase shifter. Circulators and isolators.	8

Text Books:

1. David M. Pozar, Microwave Engineering, 4/e, Wiley India, 2012.
2. Robert E. Collin, Foundation of Microwave Engineering, 2/e, Wiley India, 2012.
3. Samuel Y. Liao, Microwave Devices and Circuits, 3/e, Pearson Education, 2003.

References:

1. Bharathi Bhat and Shiban K. Koul: Stripline-like Transmission Lines for MIC, New Age International (P) Ltd, 1989.
2. I. Kneppo, J. Fabian, et al., Microwave Integrated Circuits, BSP, India, 2006.
3. Leo Maloratsky, Passive RF and Microwave Integrated Circuits, Elsevier, 2006.

Course Contents and Lecture Schedule.

No	Topic	No.of Lectures
Module I		
1.1	Introduction, Characteristic, features of microwaves, Limitation of conventional solid state devices at Microwave	2
1.2	Gunn – effect diodes – Gunn effect, Ridley – Watkins-Hilsum theory, Modes of operation, Limited space – Charge accumulation (LSA) mode of Gunn diode.	2
1.3	Microwave generation and amplification. Structure, Operation, Power output and efficiency of IMPATT and TRAPATT diodes	2
Module II		
2.1	Bipolar transistors – biasing, FET – biasing, MESFET – Structure, Operation.	3
2.2	Microwave amplifiers and oscillators – Amplifiers – Gain and stability, Single stage transistor amplifier design.	3
2.3	Oscillator design – One port negative resistance oscillators.	2
Module III		
3.1	Microwave Network Analysis – Equivalent voltages and currents, Impedance and Admittance matrices, Scattering matrix, The transmission matrix	2
3.2	Signal flow graphs. Impedance matching and tuning – Matching with lumped elements, Single stub tuning, Double stub tuning.	2
3.3	Quarter wave transformer, Theory of small reflections.	2
Module IV		
4.1	Microwave filters, Periodic structures, Analysis of periodic structures	2
4.2	Filter design by image parameter method – Constant k, m-derived and composite.	3
4.3	Filter design by insertion loss method. Filter transformation and implementation.	2
Module V		
5.1	Introduction to MICs:-Technology of hybrid MICs, monolithic MICs. Comparison of both MICs.	2
5.2	Planar transmission lines such as stripline, microstrip line, and slotline.	2
5.3	Distributed and lumped elements of integrated circuits - capacitors, inductors, resistors, terminations, attenuators, resonators and discontinuities.	2
5.4	Diode control devices – switches, attenuators, limiters. Diode phase shifter. Circulators and isolators.	2

Model Question Paper**APJ ABDUL KALAM TECHNOLOGICAL UNIVERSITY****EIGHTH SEMESTER B. TECH DEGREE EXAMINATION****Course Code: ECT446****Course Name: MICROWAVE DEVICES AND CIRCUITS**

Max. Marks:100

Duration: 3 Hours

PART A*(Answer All Questions)*

- 1 With a graph explain the characteristics of Gunn diode. (3)
- 2 Explain the limitations of conventional solid state devices at microwaves (3)
- 3 Design a one port negative resistance oscillator (3)
- 4 Discuss different biasing techniques used for microwave bipolar transistor. (3)
- 5 Derive expressions for S parameters in terms of Z parameters for a 2-port network. (3)
- 6 Explain the principle of double stub matching. (3)
- 7 Discuss the significance of k- β diagram in filter characteristics. (3)
- 8 List the Kuroda's identity. (3)
- 9 The strip line designed with a dielectric material with $b = h = 3.1$ mm, $w = 2.5$ mm
Find characteristic impedance Z_0 . $\sqrt{\epsilon_r} = \sqrt{10.5}$ (3)
- 10 Explain the configuration of distributed ferrite circulators. (3)

PART B*(Answer one question from each module. Each question carries 14 marks)***MODULE I**

- 11 a) What does IMPATT diode stand for and with neat diagram mention construction and working of it and derive power and η of the same. (10)
 - b) Explain modes of operation of Gunn diode. (4)
- OR**
- 12 a) What are TRAPATT diodes? Explain elaborately their principle of operation with neat diagram. (10)
 - b) An IMPATT diode has carrier drift velocity $V_d = 3 \times 10^7$ cm/s, Drift region length $L = 6\mu\text{m}$, Maximum operating voltage $V_{0\text{max}} = 100\text{V}$, Maximum operating current $I_{0\text{max}} = 200\text{mA}$, Efficiency $\eta = 15\%$, Breakdown voltage $V_{bd} = 90\text{V}$. Find maximum CW output power in watts and the resonant frequency in gigahertz. (4)

MODULE II

- 13 a) Design a single stage Transistor Amplifier used in microwave circuits. (10)
 b) Why are GaAs MESFET's preferred to Si MESFET's (4)

OR

- 14 a) Discuss in detail the physical structure of MESFET and explain its principle of operation. (10)
 b) Discuss briefly the Stability of Amplifier with necessary conditions. (4)

MODULE III

- 15 a) For a microwave circuit, discuss the equivalent voltage and currents. (6)
 b) Explain working of Double Stub tuning and Quarter Wave Transformer. (8)

OR

- 16 a) Explain in detail the concept of matching with lumped elements. (6)
 b) Discuss in detail about impedance and frequency scaling. (8)

MODULE IV

- 17 a) Explain the steps in designing a composite filter. Also write down the equations and draw the circuit for designing a composite low pass filter. (8)
 b) Design a low pass filter for fabrication using microstrip line. The specifications are cut-off frequency of 4 GHz, third order, impedance of 50Ω and a 3 dB equi-ripple characteristics. The normalized low pass proto-type values are $g_1 = 3.3487 = L_1$, $g_3 = 3.3487 = L_3$, $g_2 = 0.7117 = C_2$, $g_4 = 1.000 = R_L$. (6)

OR

- 18 a) Design a low pass constant K filter using image parameter method. (7)
 b) What are the steps required to transfer a LPF from HPF .explain. (7)

MODULE V

- 19 a) Explain in detail about thick film and thin film technology? (9)
 b) Discuss Microwave resonators with neat diagram (5)

OR

- 20 a) Classify Switches based on Characteristics (8)
 b) Discuss briefly about slot line. (6)

Assessment Pattern

Bloom's Category		Continuous Assessment Tests		End Semester Examination
		1	2	
Remember	K1	10	10	20
Understand	K2	30	30	60
Apply	K3	10	10	20
Analyse				
Evaluate				
Create				

Mark distribution

Total Marks	CIE	ESE	ESE Duration
150	50	100	3 hours

Continuous Internal Evaluation Pattern:

Attendance	: 10 marks
Continuous Assessment Test (2 numbers)	: 25 marks
Assignment/Quiz/Course project	: 15 marks

End Semester Examination Pattern: There will be two parts; Part A and Part B. Part A contain 10 questions with 2 questions from each module, having 3 marks for each question. Students should answer all questions. Part B contains 2 questions from each module of which student should answer any one. Each question can have maximum 2 sub-divisions and carry 14 marks. Mark patterns are as per the syllabus with 80 % for theory and 20% for logical/numerical problems, derivation and proof.

Course Level Assessment Questions

Course Outcome 1 (CO1): Speech Processing, Parametric representation of speech, LPC analysis

1. Describe algorithm for computing LPC coefficients using autocorrelation method
2. Define short time energy and short time zero crossing rate

Course Outcome 2 (CO2): Frequency domain analysis, Speech coding, Speech enhancement

1. Describe the steps involved in obtaining MFCC coefficients of a speech signal

2. Compare broad categories of speech coding techniques in terms of bitrate and speech quality

Course Outcome 3 (CO3): Models of Audio perception, Psychoacoustic analysis

1. Explain MPEG psycho-acoustic model of audio perception
2. Differentiate between simultaneous masking and temporal masking

Course Outcome 4 (CO4): Audio compression methods, Transform coding of Audio signals

1. Describe various redundancy removal and perceptual irrelevancy removal in audio compression
2. Explain the concept of MDCT and its properties

Course Outcome 5 (CO5): Audio Perception and rendering

1. Explain subjective and objective analysis methods to measure the audio quality
2. What are the physical and psycho-acoustical basis of sound localization and space perception Describe spatial audio standards

Syllabus

Module	Course contents	Hours
I	Speech Production: Acoustic theory of speech production. Speech Analysis: Speech signal, Short-Time Speech Analysis, Time domain analysis (Short time energy, short time zero crossing Rate, ACF).LPC Analysis (LPC model, Auto correlation method).	7
II	Frequency domain analysis (Filter Banks, STFT, Spectrogram), Cepstral Analysis, MFCC. Probabilistic formulation of speech recognition, Speech coding: fundamentals, Comparison of waveform coding, vocoding and hybrid coding, Speech enhancement: fundamentals, basic types, Speaker verification (block diagram), Language Identification (block diagram)	7
III	Signal Processing Models of Audio Perception: Basic anatomy of hearing System. Auditory Filter Banks, Psycho-acoustic analysis: Critical Band Structure, Absolute Threshold of Hearing, Simultaneous Masking, Temporal Masking, MPEG psycho-acoustic model.	7
IV	Audio compression methods: Sampling rate and bandwidth requirement for digital audio, Redundancy removal and perceptual irrelevancy removal, Transform coding of digital audio: MPEG2-AAC coding standard, MDCT and its properties, Pre-echo and pre-echo suppression, Loss less coding methods.	7

V	Spatial Audio Perception and rendering: The physical and psycho-acoustical basis of sound localization and space perception. Spatial audio standards. Audio quality analysis: Objective analysis methods-PEAQ, Subjective analysis methods - MOS score, MUSHRA score	7
---	--	---

Text Books:

1. Douglas O'Shaughnessy, Speech Communications: Human & Machine, IEEE Press, Hardcover 2/e, 1999; ISBN: 0780334493.
2. Nelson Morgan and Ben Gold, Speech and Audio Signal Processing: Processing and Perception Speech and Music, July 1999, John Wiley & Sons, ISBN: 0471351547

References:

1. Donald G. Childers, Speech Processing and Synthesis Toolboxes, John Wiley & Sons, September 1999; ISBN: 0471349593
2. Rabiner and Juang, Fundamentals of Speech Recognition, Prentice Hall, 1994.
3. Rabiner and Schafer, Digital Processing of Speech Signals, Prentice Hall, 1978.
4. Thomas F. Quatieri, Discrete-Time Speech Signal Processing: Principles and Practice, Prentice Hall; ISBN: 013242942X; 1/e

Course content and Lecture plan

No	TOPIC	No of Lectures
MODULE 1		
1.1	Acoustic theory of speech production	2
1.2	Speech signal, Short-time analysis of speech	2
1.3	Time domain analysis (Short time energy, short time zero crossing Rate, ACF)	2
1.4	LPC Analysis	1
MODULE II		
2.1	Frequency domain analysis (Filter Banks, STFT, Spectrogram)	2
2.2	Cepstral Analysis	1
2.3	MFCC.	1
2.4	Fundamentals of Speech recognition, Speech coding, Speech Enhancement	1
2.5	Speaker Verification,	1
2.6	Language Identification	1
MODULE III		
3.1	Signal Processing Models of Audio Perception	1
3.2	Basic anatomy of hearing System.	1
3.3	Auditory Filter Banks, Psycho-acoustic analysis.	2
3.4	Critical Band Structure, Absolute Threshold of Hearing.	1

3.5	Simultaneous Masking, Temporal Masking,	1
3.6	MPEG psycho-acoustic model	1
MODULE IV		
4.1	Sampling rate and bandwidth requirement for digital audio,	2
4.2	Redundancy removal and perceptual irrelevancy removal,	1
4.3	Transform coding of digital audio: MPEG2-AAC coding standard	1
4.4	MDCT and its properties,	1
4.5	Pre-echo and pre-echo suppression,	1
4.6	Lossless coding methods.	1
MODULE V		
5.1	Spatial Audio Perception and rendering	2
5.2	The physical and psycho-acoustical basis of sound localization and space perception.	2
5.3	Spatial audio standards.	1
5.4	Audio quality analysis: Objective analysis methods- PEAQ	1
5.5	Subjective analysis methods - MOS score, MUSHRA score	1

Model Question paper**APJ ABDUL KALAM TECHNOLOGICAL UNIVERSITY**

VIII SEMESTER B. TECH DEGREE EXAMINATION

Course Code: ECT456

Course Name: SPEECH AND AUDIO PROCESSING

Max. Marks: 100

Duration: 3 Hours

PART A		
Answer all questions, each carries 3 marks		
1.	What is Zero Crossing Rate (ZCR) ? How is it used for differentiating voiced and unvoiced speech?	
2	Why short time analysis is preferred for analysing speech signal	
3	Express speech recognition in terms of probabilistic formulation and justify the importance of each term.	
4	What is the need for Spectrogram representation of speech signals	
5	Differentiate between speaker identification and speaker verification	
6	How is 'bit allocation' used in MPEG?	
7	What is threshold of hearing? Explain with the help of a diagram	

8	Draw and explain the concept of threshold of hearing	
9	What is redundancy removal in audio compression?	
10	What is cone of confusion? How do listeners resolve it?	
	PART B	
	Answer any one full question from each module carries 14 marks.	
	MODULE I	
11	a) Draw the source system model of speech production. Derive equations of LP analysis using autocorrelation method.	7
	b) Write mathematical expression for the computation of short time energy and short time auto correlation for a speech segment	7
	OR	
12	Describe human speech production mechanism using a diagram and the role of following organs in speech production (i) Velum (ii) Vocal folds (iii) Lips (iv) Tongue	14
	MODULE II	
13	a) Define mathematically the need of STFT for analyzing speech signals.	7
	b) Describe with the help of a block diagram the steps involved in obtaining MFCC coefficients of a speech signal.	7
	OR	
14	a) Formulate 'automatic speech recognition' using probabilistic terms	7
	b) Explain any one speech coding technique in detail	7
	MODULE III	
15	a) Draw and explain the concept of auditory filter banks	7
	b) With the help of neat diagram explain the anatomy of hearing system	7
	OR	
16	a) Differentiate between simultaneous masking and temporal masking	6
	a) Explain MPEG psycho acoustic model. How is masking useful for implementing audio compression?	8

MODULE IV		
17	a) Explain mathematically the concept of MDCT and its properties.	7
	b) Explain MPEG2-AAC coding standard	7
OR		
18	a) Describe pre-echo suppression in audio signals	7
	b) Briefly explain lossless coding of audio signals	7
MODULE V		
19	a) Differentiate between Interaural level difference (ILD) and Interaural time difference (ITD) in perception with help of diagrams	7
	b) Explain any two spatial audio standards.	7
OR		
20	a) Describe objective analysis method to analyze the audio quality.	8
	b) Mention the significance of MOS score and MUSHRA score	6



ECT466	ANALOG CMOS DESIGN	CATEGORY	L	T	P	CREDIT
		PEC	2	1	0	3

Preamble: This course aims to impart the basic knowledge of CMOS analog circuits design and enable the students to design integrated circuits.

Prerequisite: ECT 202 Analog Circuits, ECT 201 Solid State Devices.

Course Outcomes: After the completion of the course the student will be able to,

CO1	Analyze various Single stage Amplifiers with different types of loads
CO2	Design and Analyse Differential Amplifiers
CO3	Design various types of current mirrors
CO4	Plot the frequency response of single stage and differential amplifiers
CO5	Analyse the effect of noise in single stage amplifiers
CO6	Implement PLL for various applications

Mapping of course outcomes with program outcomes

	PO0 1	PO0 2	PO0 3	PO0 4	PO0 5	PO0 6	PO0 7	PO0 8	PO0 9	PO1 0	PO1 1	PO1 2
CO 1	3	3										2
CO 2	3	3										2
CO 3	3	3										2
CO 4	3	3										2
CO 5	3	3										2
CO 6	3	3										2

Assessment Pattern

Bloom's Category		Continuous Assessment Tests		End Semester Examination
		1	2	
Remember	K1	10	10	10
Understand	K2	20	20	20
Apply	K3	20	20	70
Analyse				
Evaluate				
Create				

Mark distribution

Total Marks	CIE	ESE	ESE Duration
150	50	100	3 hours

Continuous Internal Evaluation Pattern:

Attendance	: 10 marks
Continuous Assessment Test (2 numbers)	: 25 marks
Assignment/Quiz/Course project	: 15 marks

End Semester Examination Pattern: There will be two parts; Part A and Part B. Part A contain 10 questions with 2 questions from each module, having 3 marks for each question. Students should answer all questions. Part B contains 2 questions from each module of which student should answer any one. Each question can have maximum 2 sub-divisions and carry 14 marks.

Course level Assessment Questions**CO1. Analyze various Single stage Amplifiers with different types of loads**

1. Develop small signal model for various amplifier configurations
2. Calculate the small signal gain of various configurations
3. Analyze the effect of cascading of stages.

CO2. Design and Analyse Differential Amplifiers

1. Perform Qualitative Analysis of Differential Pair.
2. Calculate the small signal gain of differential pair if the bias voltages are equal.
3. Calculate the overdrive voltage of each transistor in differential pair.

CO3. Design various types of current mirrors

1. Explain the use of current mirrors to bias a differential pair
2. Explain the concept of an active current mirror.
3. Analysis of circuits having current mirror.

CO4:Plot the frequency response of single stage and differential amplifiers

1. Calculation of poles associated with the nodes in a circuit
2. Calculate the voltage transfer function of common source stage
3. Modelling the high frequency equivalent circuit of various configurations.

CO5:Analyse the effect of noise in single stage amplifiers

1. Modelling of noise in circuits.
2. Calculation of Input referred noise and output noise in various circuits.
3. Calculation of noise bandwidth

CO6: Implement PLL for various applications

1. Describe the implementation of PLL for Frequency Multiplication, Frequency synthesizer and Skew reduction

SYLLABUS**Module I**

Basic MOS Device physics- Review of MOS Characteristics and Second order effects(only basic theoretical concepts).

Single Stage Amplifiers. Common Source Stage with Different Load types , Source Follower, Common Gate and Cascode Stage

Module II

Differential Amplifiers - Single-ended and differential operation, Basic differential pair, Common-mode response, Differential pair with MOS load, Gilbert Cell.

Current Mirror: Simple, Cascode and Basic concepts of active current Mirror

Module III

Frequency Response of Amplifiers: Miller Effect, Poles and Zeros, Frequency Response Analysis of Common Source, Source Follower, Common Gate and Differential Pair.

Module IV

Noise in Amplifiers: Noise in Single Stage amplifier (CS,CG,Source Follower), Noise in Differential Pair, Noise Band Width.

Module V

Phase Locked Loops- Mathematical model of VCO, Phase Detector, Basic PLL Topology, Type I and Type II(Charge Pump) PLL, Stability Analysis of PLL, Non Ideal Effects in PLL, Application of PLL- Frequency Multiplication, Frequency synthesizer and Skew reduction. Block Diagram of Digital PLL.

Text Books:

1. Behzad Razavi, "Design of Analog CMOS Integrated Circuits", McGraw-Hill, 2/e, 2002

References:

1. Phillip E. Allen, Douglas R. Holbery, CMOS Analog Circuit Design, Oxford, 2004.
2. Razavi B., Fundamentals of Microelectronics, Wiley student Edition 2014.
3. Baker, Li, Boyce, CMOS: Circuits Design, Layout and Simulation, PHI, 2000

Course Contents and Lecture Schedule

No.	Topic	Hrs.
1	CMOS Amplifiers	
1.1	Review of MOS Characteristics, Second order effects(Subthreshold conduction, DIBL, Velocity Saturation etc..)	1
1.3	Single Stage Amplifiers-Basic Concepts	1
1.4	CS with resistive, Diode Connected and Current Source Load, CS with source Degeneration	3
1.5	Source Follower and common Gate Stage	2
1.6	Cascode Stage	1
2	Differential Amplifier	
2.1	Single Ended and Differential Operation	1
2.2	Common Mode Response, Differential pair with MOS Load	2
2.3	Concept of Gilbert Cell and Introduction to Basic Current Mirror	1
2.4	Cascode current Mirrors and Basic Concepts of Active Current Mirrors	2
3	Frequency Response of Amplifiers	
3.1	Miller Effect, Poles and Zeros	1
3.2	Calculation of poles and zeros of CS, CG and Source follower stage	2
3.3	Stability Analysis of CS, CG and Source Follower	2
3.4	Frequency Response of Differential Pair	1
4	Noise In Amplifiers	
4.1	Noise analysis in CS, CG and Source Follower	4
4.2	Noise In differential Pair	2
4.3	Noise Bandwidth	1
5	Phase Locked Loops	
5.1	Mathematical model of VCO, Phase Detector, Basic PLL Topology	1
5.2	Type I and Type II(Charge Pump) PLL, Stability Analysis of PLL	2
5.3	Non Ideal Effects in PLL	2
5.4	Application of PLL- Frequency Multiplication, Frequency synthesizer and Skew reduction	2
5.5	Block Diagram of Digital PLL	1
Total Hours		35

Simulation Assignments:

Atleast one assignment should be simulation of the circuits. Simulations can be done in QUCS, KiCad or PSPICE or LT Spice or CADENCE

Model Question Paper

APJ ABDUL KALAM TECHNOLOGICAL UNIVERSITY
EIGHTH SEMESTER B.TECH DEGREE EXAMINATION, (Model Question Paper)

Course Code: ECT466

Course Name: ANALOG CMOS DESIGN

Max. Marks: 100

Duration: 3 Hours

PART A

Answer ALL Questions. Each Carries 3 mark.

1	Explain Body effect. How body Effect affect the Threshold voltage	K1
2	Draw the small signal equivalent circuit of a common source stage with diode connected load?	K2/CO1
3	Calculate the Common mode Gain of a differential Pair.	K2/CO2
4	Explain the working of Gilbert Cell as Analog voltage Multiplier	K2/CO3
5	Explain how the addition of capacitor at output node of a single stage amplifier affect the pole zero plot.	K2/CO4
6	Draw the Thevinin Equivalent of a Differential Pair with active current Mirror	K3/CO4
7	Draw the circuit model for a resistor thermal noise and draw its spectral density.	K3/CO5
8	Explain Flicker Noise?	K1/CO5
9	Explain the working of Phase Detectors?	K1
10	Explain the Block diagram of Digital PLL?	K1

PART – B

Answer one question from each module; each question carries 14 marks.

Module – I

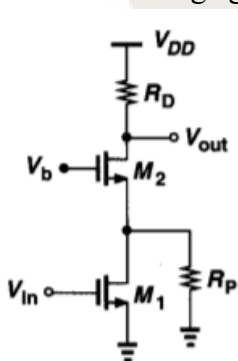
11a.	Derive the expression of a common source stage with diode connected load.	7 CO1/ K3
b.	Calculate the voltage gain of the circuit 	7 CO1/ K3

OR

12a.	Derive the expression of Voltage gain of Common Gate Stage?	14 CO1/ K3
------	---	------------------

Module – II

13a.	Explain the working of a basic differential pair	4
------	--	---

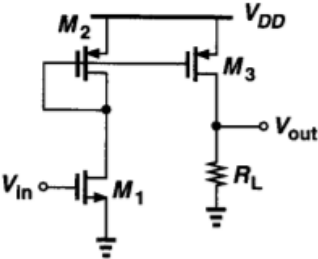
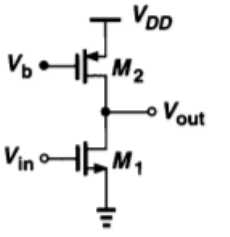
		CO2/ K1
b.	Derive the expression of the voltage gain of a differential pair with MOS Load	10 CO2/ K3
OR		
14	Calculate the small signal voltage gain of the circuit shown below.	14 CO3/ K3
		
Module – III		
15a.	Explain Miller Effect	4 K1
b.	Calculate the input and output impedance of common source stage	10 CO4/K3
OR		
16	Derive the expression for voltage transfer function and input impedance of common gate configuration.	14 CO4/ K3
Module - IV		
17a.	Calculate the total input referred thermal noise voltage of the amplifier shown below.	14 CO5/K3
		
OR		

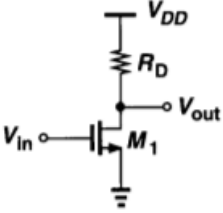
18	Calculate the total output noise of the circuit shown below. <div style="text-align: center;">  </div>	14 CO5/ K3
Module – V		
19a.	Explain Type 1 and charge pump PLL?	5 K1
b.	Explain various non ideal effects in PLL?	9 K1
OR		
20a.	Describe various applications of PLL	10 CO6/ K3
b.	Describe the causes of stability degradation in charge pump PLL.	4/K2



ECT476	ROBOTICS	CATEGORY	L	T	P	CREDIT
		PEC	2	1	0	3

Preamble: The objective of this course is to introduce to the students the emerging field of robotics by imparting the fundamental knowledge on the design and control of robots, their multi-disciplinary engineering aspects and applications.

Prerequisite: Nil

Course Outcome: After the successful completion of the course, the student will be able to

CO1	Attain a thorough understanding of different types of Robots and their applications
CO2	Select appropriate sensors and actuators based on the robotic applications
CO3	Perform kinematic and dynamic analyses for robots.
CO4	Carry out the design and control of a simple robot.
CO5	Integrate mechanical and electrical hardware for making a robotic device

Mapping of course outcomes with program outcomes

	PO1	PO2	PO3	PO4	PO5	PO6	PO7	PO8	PO9	PO10	PO11	PO12
CO1	3	3										
CO2	3	3										
CO3	3	3										
CO4	3	3		2								
CO5	3	3		2								

Assessment Pattern

Bloom's Category	Continuous Assessment Tests		End Semester Examination
	1	2	
Remember	10	10	20
Understand	30	30	60
Apply	10	10	20
Analyse			
Evaluate			
Create			

Mark distribution

Total Marks	CIE	ESE	ESE Duration
150	50	100	3 hours

Continuous Internal Evaluation Pattern:

Attendance	: 10 marks
Continuous Assessment Test (2 numbers)	: 25 marks
Assignment/Quiz/Course project	: 15 marks

Semester Examination Pattern: There will be two parts; Part A and Part B. Part A contain 10 questions with 2 questions from each module, having 3 marks for each question. Students should answer all questions. Part B contains 2 questions from each module of which student should answer anyone. Each question can have a maximum of two sub-divisions and carry 14 marks.

Course Level Assessment Questions

Course Outcome 1 (CO1): Appreciate the classification of robots, fundamental systems and their applications in various domains.

1. Write down the brief history and growth of robotics.
2. Describe the different basic components of a robotic system and their functions.
3. Explain the principle of degree of freedom or connectivity in terms of robotic joints.

Course Outcome 2(CO2): Compare and contrast the working principles and applications of various sensors and actuators used in robotic systems.

1. With neat sketches elucidate the working of any one type of tactile sensor used for contact and proximity assessment.
2. Describe the imaging, sensing and digitization processes in a basic robotic vision system.
3. List and justify any two applications where pneumatic actuators are preferred over hydraulic ones.

Course Outcome 3 (CO3): Apply the principles and techniques of kinematic and dynamic modelling in robotics.

1. Describe the techniques and methods for the representation of position and orientation of objects, their translation and rotation, as well as the coordinate transformation in the workspace of a robot.
2. Explain the Denavit-Hartenberg (D-H) convention for selecting frames of reference in robotics applications.
3. Apply the D-H convention to represent the different serial kinematic arrangements fitted with various end effectors.

Course Outcome 4 (CO4): Perform basic programming for the control of robotic devices.

1. Explain the process of control of position and force of manipulators in robots.
2. Illustrate the working of a robotic device using the closed-loop control system with a suitable example.
3. Describe the commonly used methods for robot programming.

Course Outcome 5 (CO5): Design robotic devices by integrating mechanical and electrical hardware.

1. List out the various industrial Applications of Robots with examples.
2. Illustrate the significance of Artificial Intelligence (AI) in Robotics
3. Evaluate the role of robotics and automation in Industry 4.0.

SYLLABUS

MODULE I

Introduction to Robotics: Definition and Origin of Robotics. Robot Anatomy. Robot Specifications. Robot Characteristics – Accuracy, Precision, and Repeatability. Classification of Robots. Advantages and Disadvantages of Robots. Robot Structure - Types of Joints and End Effectors, Mechanisms and Manipulators. Common Kinematic Arrangements. Degree of Freedom. Robot Coordinates. Reference Frames. Robot Workspace. Areas of Application for Robots.

MODULE II

Introduction to Sensors and Actuation Systems for Robots: Actuators: Types of Robotic Drive Systems and Actuators: Hydraulic, Pneumatic and Electric drives. Transmission: Gears, Timing Belts and Bearings. Parameters for selection of actuators. Specification. Areas of Application for: Stepper Motor, Servo Motor and Brushless DC Motor. Microprocessor Control of Motors. Speed Control using PWM and Direction Control using H- Bridge. Sensors: Types and Applications of Sensors in Robotics: Position, Displacement and Velocity Sensors. Tactile Sensors for Contact and Proximity Assessment. Strain Gauge based Force and Torque Sensors. Tachometers, etc. Robotic Vision Systems- Introduction to Cameras, Imaging, Sensing and Digitization. Vision Applications in Robotics.

MODULE III

Introduction to Robot Kinematics and Dynamics: Introduction to Kinematics: Position and Orientation of Objects. Rotation. Euler Angles. Rigid Motion Representation using Homogenous Transformation Matrix. Kinematic Modelling: Translation and Rotation Representation, Coordinate Transformation, Forward and Inverse Kinematics. *Forward Kinematics*-Link Coordinates, Denavit-Hartenberg Representation, Application of DH Convention to Different Serial Kinematic Arrangements. *Inverse Kinematics* – General Properties of Solutions, Kinematic Decoupling, *Velocity Kinematics* – Derivation of the Jacobian, Application of Velocity Kinematics for Serial Manipulators, Importance of Singularities. Introduction to Dynamic Modelling: *Forward and Inverse Dynamics*- Equations of Motion using Euler-Lagrange formulation, Newton Euler Formulation.

MODULE IV

Introduction to Robot Control: Basics of Control: Open Loop- Closed Loop, Transfer Functions, Control Laws: P, PD, PID, Linear and Non-linear Controls; Control Hardware and Interfacing; Embedded Systems: Microcontroller Architecture and Integration with Sensors, Actuators, Components. Introduction to Robot Programming – Programming Methods, Robot

Language Classification, Robot Language Structure, Elements and its Functions. Motion, End-Effector and Sensor Commands in VAL Programming Language. Simple Programs.

MODULE V

Recent Developments in Robotics. Mobile Robots: Mobile Robot Kinematics, Navigation. Humanoid Robotics: Biped Locomotion, Imitation Learning. Collaborative Robots: Collaborative Robot, Collaborative Operation, Applications. Artificial Intelligence in Robotics: Applications in Unmanned Systems, Defense, Medical, Industries, etc. Industrial Applications of Robots in Material Handling and Assembly. Robotics and Automation for Industry 4.0., Robot Safety. Social Robotics.

Text Books:

1. S.K. Saha, Introduction to Robotics, Tata McGraw Hill, 2nd Edition, 2014
2. Saeed B. Niku, Introduction to Robotics: Analysis, Systems, Applications, John Wiley & Sons, 2nd Edition, 2011.
3. Spong and Vidyasagar, Robot Dynamics and Control, John Wiley & Sons, 1990.
4. Mikell P. Groover, et al., Industrial Robotics – Technology, Programming and Applications, McGraw Hill, 2nd Edition, 2012

Reference Books:

1. John. J.Craig, Introduction to Robotics: Mechanics and Control, PHI, 2005.
2. Ashitava Ghosal, Robotics, Fundamental concepts and analysis, OXFORD University Press, 2006
3. Fu, K.S., Gonzalez, R.C., Lee, C.S.G., Robotics, Control, Sensing, Vision and Intelligence, McGraw-Hill, 1987.
4. Asada, H., and J. J. Slotine. *Robot Analysis and Control*. New York, NY: Wiley, 1986.
5. Robert J. Schilling, Fundamentals of Robotics: Analysis & Control, Pearson Education, 2000
6. Klafter, R.D., Chmielewski, T.A., Negin, M, Robotic Engineering An Integrated Approach, PHI, 2007
7. S. R. Deb, Robotics Technology and Flexible Automation, Tata McGraw Hill, New Delhi, 1994.

Course Plan Course Contents and Lecture Schedule

No	Topic	No. of Lectures
1	Module 1: Introduction to Robotics	
1.1	Definition and Origin of Robotics: What is the basic definition of a robot? How the field of robotics originated? What are the basic components of a robot? How to specify a robot?	1
1.2	Characteristics, Classification, Advantages and Disadvantages of Robots: What are the different characteristic parameters of robots? How robots are	1

	classified? What are the advantages of using robots in various applications? Are there any disadvantages to employing robots?	
1.3	<p>Robot Structure, and Common Kinematic Arrangements:</p> <p>What are the different structural arrangements for robots? What are the different types of joints, end effectors, mechanisms and manipulators commonly used in robotics? How to express the structure of robots in terms of common kinematic arrangements?</p>	1
1.4	<p>Concepts of Degree of Freedom (DOF), Coordinates, Reference Frames, Workspace in Robotics:</p> <p>How to define the degree of freedom of any robot? What are the commonly used coordinate systems for robots? How the concept of reference frames help in a robot design? How to determine the workspace of a robot?</p>	1
1.5	<p>Areas of Application for Robots:</p> <p>What are different fields/areas where robots find applications? How the size, structure, sensors, DOF and end effector change with applications?</p>	1
1.6	<p>Areas of Application for Robots:</p> <p>Suggest some new or futuristic fields/areas where robots may find applications?</p>	1
2	Module 2: Introduction to Robotic Sensors and Actuators	
2.1	<p>Robotic Drive Systems and Actuators:</p> <p>What are the different types of drive systems used in robotics? Describe the different transmission systems used in robots and their specific applications.</p>	1
2.2	<p>Types and Applications of Actuators in Robotics:</p> <p>What are the different deciding parameters for selecting appropriate actuators for robots? How are actuators specified? What are the specific applications for stepper motors, servo motors and brushless DC motors in robotics?</p>	1
2.3	<p>Types and Applications of Sensors in Robotics:</p> <p>What are the different position, displacement and velocity sensors used in robots? How do the tactical sensors used in robotic devices sense contact and proximity of objects? What are the commonly used force and torque sensors in robots? How do tachometers help in robotic operation and application?</p>	1
2.4	<p>Control of Motors in Robotics:</p> <p>How to perform microprocessor-based control in electric motors? How speed control is carried out using pulse-width modulation? Describe direction control using H-Bridge.</p>	1
2.5	<p>Robotic Vision Systems:</p> <p>What is the role of cameras in robots? Describe how imaging, sensing and</p>	1

	digitization processes are performed in robotic applications. What are the vision applications of robots?	
2.6	Control of Robotics: Conduct exercises to develop small control programs for joints/links/end effectors of robots.	1
3	Module 3: Introduction to Robot Kinematics and Dynamics	
3.1	Introduction to Kinematics: How to specify the position and orientation of links and joints in robotics? What are the common methods for describing robot orientations? Describe how rigid motion can be made using a homogenous transformation matrix.	1
3.2	Kinematic Modelling: How to determine the position and orientation of an end effector of a robot under translation and/or rotation? What is the coordinate transformation method? How transformations can be performed between the coordinate frames attached to different robotic links and joints. What are the purposes for forward and inverse kinematics in robotics?	1
First Series Examination		
3.3	Forward Kinematics: How to compute the position of the end effector from joint parameters? What is Denavit-Hartenberg representation? How the D-H convention can be applied to different serial kinematic arrangements.	1
3.4	Inverse Kinematics: How to predict the joint angles from the known coordinates of the end effector of a robot? How kinematic decoupling is performed in robotic manipulators?	1
3.5	Velocity Kinematics: How can the linear and angular velocities of the end effector get related to the joint velocities to form the velocity relationship? How can velocity kinematics be applied to serial robots? What are the different singularities that affect the degree of freedom of robots?	1
3.6	Introduction to Dynamic Modelling: What are the functions of forward and inverse dynamics in robotics? How can we develop the equations of motion using the Euler-Lagrange formulation? What is the role of Newton-Euler formulation in the dynamic modelling of robots?	2
4	Module 4: Introduction to Robot Control	
4.1	Basics of Control: Describe the basic control parameters and systems used in robotics? How P, PD, PID, Linear and Non-linear Controls are employed in robotic practices?	2
4.2	Control Hardware and Interfacing:	2

	What are the advantages of using the embedded system in robotics? How microcontrollers can integrate sensors, actuators and components within a robotic system?	
4.3	Introduction to Robot Programming: What is robot programming? What are different programming methods for robots? How the robot languages are classified? Describe the structure, elements, and functions of robot language.	2
4.4	Introduction to Robot Programming: What is the role of variable assembly language (VAL) programming in robotics? What are the common commands used for motion, end effector and sensors?	1
4.5	Introduction to Robot Programming: Using simple programs, conduct exercises to develop the robot programming skills of students.	2
5	Module 5: Recent Developments in Robotics.	
5.1	Mobile Robots: What are mobile robots? How the kinematics change with mobile robots? Describe the navigation of mobile robots.	1
5.2	Humanoid Robotics: How to humanoid robots are different from other types? What is biped locomotion? What are the challenges involved in the static and dynamic balance of biped robots? What is the application of imitation learning in humanoid robots?	1
5.3	Collaborative Robots: What are collaborative robots? How can collaborative operation put it into practice for robots? What are the different applications of collaborative robots?	1
5.4	Artificial Intelligence (AI) in Robotics: What are the different applications of AI in robotics? How AI helps in the development of unmanned robotic systems What are the different applications of AI-based robots in the defense, medical, industrial and other domains?	2
5.5	Industrial Applications of Robots: What are the applications of robots in different industries? How robots have a greater role today in material handling and assembly? What is the contribution of robotics towards Industry 4.0.	1
5.6	Robot Ethics, Robot Safety and Social Robotics What the ethical practices necessary for the design, production and application of robots today? What are the aspects of occupational safety and health of humans when robots are used in the workplace? What are social robots? How are social robots suppose to help humans?	1
Second Series Examination		

Model Question Paper

A P J ABDUL KALAM TECHNOLOGICAL UNIVERSITY
EIGHTH SEMESTER B TECH DEGREE EXAMINATION
COURSE: ECT476 ROBOTICS
TIME: 3 HRS MAX. MARKS: 100

PART A*Answer All Questions*

- | | | |
|----|--|---|
| 1 | List out the different criteria based on which robots are classified. | 3 |
| 2 | What are the basic components of a robot? | 3 |
| 3 | Determine the advantages of using electric drive systems in robots. | 3 |
| 4 | Identify the sensors used in robots for sensing position and velocity. | 3 |
| 5 | Recognize the need for Denavit-Hartenberg convention in robotics. | 3 |
| 6 | Describe joint angle, joint distance, link length and link twist. | 3 |
| 7 | How is the speed of an electric motor controlled using a microprocessor? | 3 |
| 8 | Distinguish between linear and rotary hydraulic actuation mechanisms. | 3 |
| 9 | Find any four non-industrial applications of robots | 3 |
| 10 | Substantiate the need for robot ethics. | 3 |

PART B*Answer one question from each module. Each question carries 14 marks.***Module I**

- | | | |
|-------|---|---|
| 11(A) | Describe the commonly used types of joints and end effectors in robots. | 8 |
| 11(B) | Explain the basic structure of any robotic system. How each component is different from the others in terms of its functionality? | 6 |

OR

- | | | |
|-------|---|---|
| 12(A) | Discuss the common kinematic arrangements in robots and find out the degree of freedom for each. | 8 |
| 12(B) | Write notes on terms like accuracy, precision, and repeatability in connection with a robotic system. | 6 |

Module II

- | | | |
|-------|--|---|
| 13(A) | Compare among hydraulic, pneumatic and electric types of robotic drives and mention the specific area of application for each. | 8 |
| 13(B) | Describe how direction control is carried out on electric motors in robots using H- Bridge. | 6 |

OR

- | | | |
|-------|---|---|
| 14(A) | Discuss the different characteristics of tactile sensors. Describe with the help of a neat diagram the working of commonly used tactile sensors | 8 |
|-------|---|---|

- 14(B) Elaborate on the imaging, sensing and digitization processes in robotic vision systems. 6

Module III

- 15(A) A frame 'B' was rotated about the x-axis 90° , then, it was translated about the current a-axis 3 inches before it was rotated about z-axis 90° . Finally, it was translated about the current a-axis 5 inches.
 a) Write an equation that describes the motion.
 b) Find the final location of a point P $(1, 5, 4)^T$ attached to the frame relative to the reference frame. 8
- 15(B) Distinguish between rotation matrix and homogenous transformation matrix. 6

OR

- 16(A) Find the Denavit-Hartenberg representation parameters of a spherical arm shown in the figure below: 8

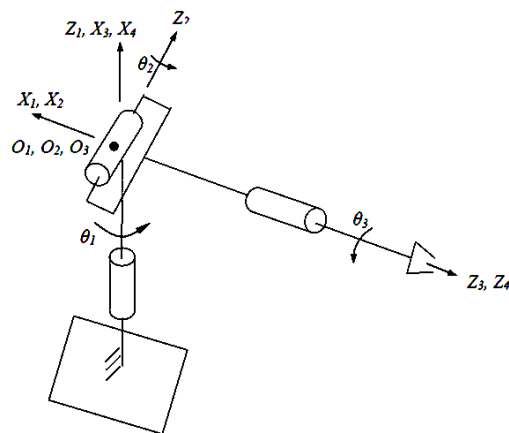

- 16(B) Describe the common kinematic arrangements of robots based on Cartesian-coordinate and Cylindrical-coordinate systems 6

Module IV

- 17(A) Discuss the different control schemes of robots 8
- 17(B) Describe the basic structure of any robot programming language. 6

OR

- 18(A) Elaborate the processes involved in robot actuation and the control methods used with block diagrams 8
- 18(B) Differentiate between textual and lead through programming methods 6

Module V

- 19(A) What are mobile robots: Describe how kinematics involved in mobile 8

robots are different from others.

19(B) Enumerate the challenges involved in biped motion of humanoid robots. 6

OR

20(A) Discuss the significant roles played by robotics in different areas for realizing Industry 4.0. 8

20(B) Examine the involvement of artificial intelligence in Robotics 6

APJ ABDUL KALAM
TECHNOLOGICAL
UNIVERSITY

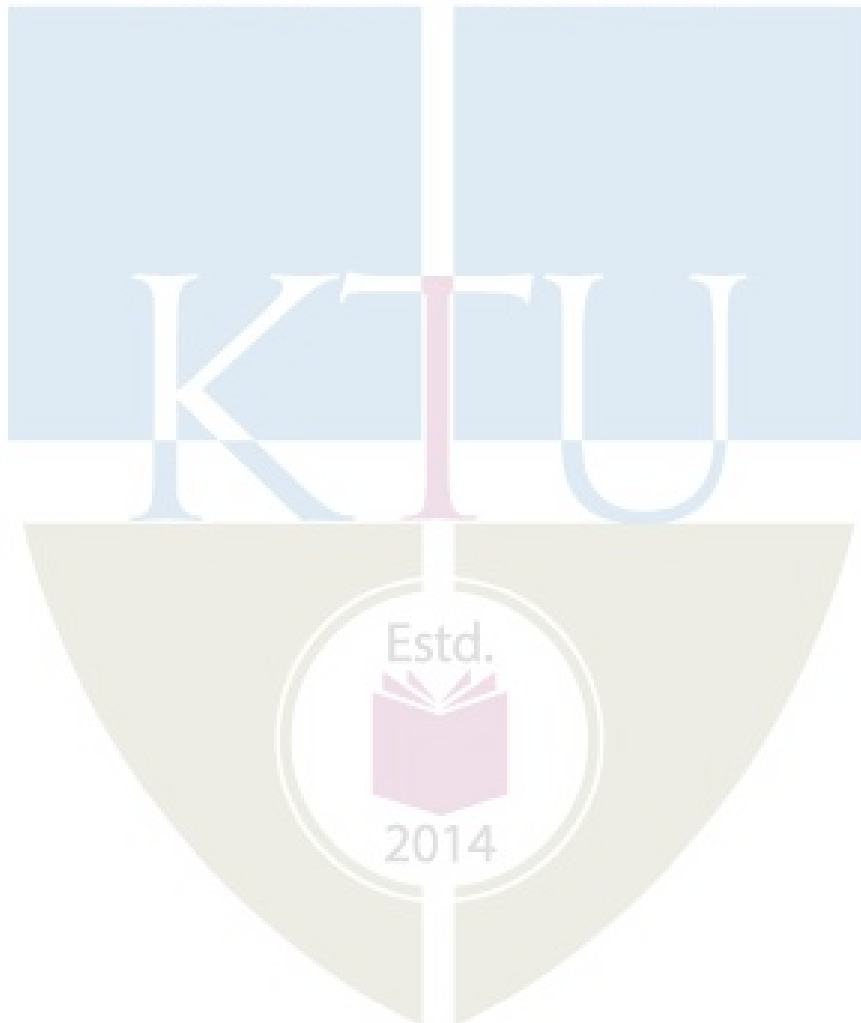

APJ ABDUL KALAM
TECHNOLOGICAL
UNIVERSITY

SEMESTER VIII

PROGRAM ELECTIVE V



ECT418	MECHATRONICS	CATEGORY	L	T	P	CREDIT
		PEC	2	1	0	3

Preamble: This course introduces students to the rapidly emerging, multi-disciplinary, and exciting field of Mechatronics.

Prerequisite: Nil

Course Outcome: After the successful completion of the course the student will be able to

CO1	Understand the working principles of various sensors and actuators in Mechatronics systems and be able to choose the suitable one for the real world application
CO2	Formulate and simulate models of mechatronics systems
CO3	Explain the implementation of PLC in mechatronics applications
CO4	Explain the standard fabrication techniques and principle of operation of MEMS devices
CO5	Design and Analysis of commonly encountered mechatronics systems for real time applications

Mapping of course outcomes with program outcomes

	PO1	PO2	PO3	PO4	PO5	PO6	PO7	PO8	PO9	PO10	PO11	PO12
CO1	3	3										
CO2	3	3										
CO3	3	3	2									
CO4	3	3										
CO5	3	3										

Assessment Pattern

Bloom's Category	Continuous Assessment Tests		End Semester Examination
	1	2	
Remember	10	10	20
Understand	30	30	60
Apply	10	10	20
Analyse			
Evaluate			
Create			

Mark distribution

Total Marks	CIE	ESE	ESE Duration
150	50	100	3 hours

Continuous Internal Evaluation Pattern:

Continuous Assessment Test (2 numbers)	: 10 marks
Assignment/Quiz/Course project	: 25 marks
	: 15 marks

End Semester Examination Pattern: There will be two parts; Part A and Part B. Part A contain 10 questions with 2 questions from each module, having 3 marks for each question. Students should answer all questions. Part B contains 2 questions from each module of which student should answer any one. Each question can have maximum 2 sub-divisions and carry 14 marks.

Course Level Assessment Questions

Course Outcome 1 (CO1): Understand the working principles of various sensors and actuators in Mechatronics systems and be able to choose the suitable one for the real world application

1. Illustrate the working of a strain gauged load cell
2. Explain the working of any one non-contact temperature measurement system
3. Explain the principle of operation and suggest two applications of Hall effect sensor in mechatronic systems.
4. With neat sketches explain the working of a double acting hydraulic actuator.
5. Design a hydraulic circuit to operate a winch fitted with a hydraulic motor. The motor should be run clockwise, counter clockwise and stopped. Use a manually operated valve.
6. Explain any two situations when pneumatic actuators are preferred over hydraulic ones.

Course Outcome 2 (CO2): Formulate models of mechatronics systems

1. Derive the mathematical model of a general electrical system and draw its analogy with a mechanical system.
2. Explain the working of a mechanical device using closed loop control system with the help of a suitable example.

Course Outcome 3 (CO3): Explain the implementation of PLC in mechatronics applications

1. Explain 'latching' in PLC logic with an example.
2. Illustrate the significance of Internal Relays in PLC program
3. Consider a pneumatic system with single-solenoid controlled valves and involving two cylinders A and B, with limit switches a⁻, a⁺, b⁻, b⁺ detecting the limits of the piston rod movements. Design a ladder programme with the requirement being when the start switch is triggered, the sequence A⁺, B⁺, A⁻, 10s time delay, B⁻ occurs and stop at that point until the start switch is triggered again.

Course Outcome 4(CO4): Explain the standard fabrication techniques and principle of operation of MEMS devices

1. Explain the steps involved in photolithography. State the chemicals used in each of the stages along with the operating conditions.
2. Explain the criteria for choice of surface or bulk micromachining techniques in the design of micro systems.
3. Explain with block diagram the steps in LIGA process. State two advantages of LIGA process over other micro machining techniques.

Course Outcome 5 (CO5): Design and Analysis of commonly encountered mechatronics systems for real time applications

1. With the help of a neat sketch explain the different mechatronics modules used in automatic car park barrier system
2. Explain with a neat sketch the mechatronic implementation of a household weighing machine
3. With a neat sketch, explain the physical system and working of a pick and place robot.

SYLLABUS

MODULE I

Introduction to Mechatronics: Structure of Mechatronics system. Comparison between traditional and mechatronics approach. Sensors - Characteristics -Temperature, flow, pressure sensors. Displacement, position and proximity sensing by magnetic, optical, ultrasonic, inductive, capacitive and eddy current methods. Encoders: incremental and absolute. Resolvers and synchros. Piezoelectric sensors. Acoustic Emission sensors. vibration sensors. Force and tactile sensors. Range finders: ultrasonic and light based range finders

MODULE II

Actuators: Hydraulic and Pneumatic actuators - Directional control valves, pressure control valves, process control valves. Rotary actuators. Development of simple hydraulic and pneumatic circuits using standard Symbols. Electrical drives: DC, AC, brushless, servo and stepper motors. Harmonic drive. Magnetostrictive actuators and piezoelectric actuators.

MODULE III

System modeling - Mathematical models and basic building blocks of general mechanical, electrical, fluid and thermal systems. Typical elements of open and closed loop control systems. Adaptive controllers for machine tools.

Programmable Logic Controllers (PLC) –Basic structure, input/ output processing. Programming: Timers, Internal Relays, Counters and Shift registers. Development of simple ladder programs for specific purposes.

MODULE IV

Micro Electro Mechanical Systems (MEMS): Fabrication: Deposition, Lithography, Micromachining methods for MEMS -Surface and Bulk, Deep Reactive Ion Etching (DRIE) and LIGA processes. Principle, fabrication and working of MEMS based pressure sensor, accelerometer and gyroscope.

MODULE V

Mechatronics in Robotics- choice of Sensors and Actuators. Robotic vision system - Image acquisition: Vidicon, charge coupled device (CCD) and charge injection device (CID) cameras. Image processing techniques: histogram processing: sliding, stretching, equalization and thresholding.

Case studies of Mechatronics systems: Automatic camera, bar code reader, simple weighing machine, pick and place robot, automatic car park barrier system, automobile engine management system.

Text Books:

1. Bolton W., Mechatronics: Electronic Control Systems in Mechanical and Electrical Engineering, Person Education Limited, New Delhi, 2007
2. Ramachandran K. P., G. K. Vijayaraghavan, M. S. Balasundaram, Mechatronics: Integrated Mechanical Electronic Systems, Wiley India Pvt. Ltd., New Delhi, 2008.
3. Saeed B. Niku, Introduction to Robotics: Analysis, Systems, Applications, Person Education ,Inc., New Delhi, 2006.
4. Devdas Shetty, Richard A. Kolk, "Mechatronics System Design", Thomson Learning Publishing Company, Vikas publishing house, Second edition, 2001.

Reference Books:

1. David G. Aldatore, Michael B. Histan, Introduction to Mechatronics and Measurement Systems, McGraw-Hill Inc., USA, 2003.
2. Gordon M. Mair, Industrial Robotics, Prentice Hall International, UK, 1998.
3. HMT, Mechatronics, Tata McGraw-Hill Publishing Company Ltd., New Delhi, 2004.
4. Vijay K. Varadan, K. J. Vinoy, S. Gopalakrishnan, Smart Material Systems and MEMS: Design and Development Methodologies, John Wiley & Sons Ltd., England, 2006.
5. Bishop, Robert H. The Mechatronics Handbook-2 Volume Set. CRC press, 2002.

Course Plan Course Contents and Lecture Schedule

No	Topic	No. of Lectures
1	Introduction to Mechatronics: Structure of Mechatronics system. Comparison between traditional and mechatronics approach	1
	Sensors - Characteristics -Temperature, flow, pressure sensors.	1
	Displacement, position and proximity sensing by magnetic, optical, ultrasonic, inductive, capacitive and eddy current methods	1
	Encoders: incremental and absolute. Resolvers and synchros.	1
	Piezoelectric sensors. Acoustic Emission sensors. vibration sensors, Force and tactile sensors	1
	Range finders: ultrasonic and light based range finders	1
2	Actuators: Hydraulic and Pneumatic actuators - Directional control valves	1
	pressure control valves, process control valves,	1
	Rotary actuators.	1
	Development of simple hydraulic and pneumatic circuits using standard Symbols.	1
	Electrical drives: DC, AC, and	1
	brushless, servo	1
	stepper motors. Harmonic drive.	1
3	System modeling - Mathematical models and basic building blocks of general mechanical, electrical, fluid and thermal systems.	2
	Typical elements of open and closed loop control systems, Adaptive controllers for machine tools	1
	Programmable Logic Controllers (PLC) –Basic structure, input/output processing.	1
	Programming: Timers, Internal Relays, Counters and Shift registers.	2
	Development of simple ladder programs for specific purposes	1
4	Micro Electro Mechanical Systems (MEMS): Fabrication: Deposition, Lithography	1
	Micromachining methods for MEMS -Surface and Bulk,	2
	Deep Reactive Ion Etching (DRIE) and LIGA processes.	1
	Principle, fabrication and working of MEMS based pressure sensor, accelerometer and gyroscope	3
5	Mechatronics in Robotics- choice of Sensors and Actuators.	1
	Robotic vision system - Image acquisition: Vidicon, charge coupled device (CCD) and charge injection device (CID) cameras.	2

	Image processing techniques: histogram processing: sliding, stretching, equalization and thresholding.	2
	Case studies of Mechatronics systems: Automatic camera, bar code reader, simple weighing machine, picks and place robot,	2
	Automatic car park barrier system, automobile engine management system.	1

Model Question Paper

A P J ABDUL KALAM TECHNOLOGICAL UNIVERSITY
EIGHTH SEMESTER B TECH DEGREE EXAMINATION
COURSE: ECT418 MECHATRONICS
TIME: 3 HRS MAX. MARKS: 100

PART A*Answer All Questions*

- | | | |
|----|--|---|
| 1 | Differentiate between absolute and incremental encoders | 3 |
| 2 | List six examples of temperature sensors | 3 |
| 3 | Explain how cushioning is achieved in pneumatic actuators with a sketch. | 3 |
| 4 | Mention any two differences between finite position and infinite position valves | 3 |
| 5 | List any 2 controlling factors in wet etching. | 3 |
| 6 | Sketch and label a MEMS based pressure sensor | 3 |
| 7 | What is latching? Draw a simple latched circuit | 3 |
| 8 | Write down the describing equations of basic mechanical building blocks | 3 |
| 9 | Illustrate the histogram processing technique for enhancing the image contrast | 3 |
| 10 | Bring out any 3 difference between CCD and CID camera. | 3 |

PART B*Answer one question from each module. Each question carries 14 marks.***Module I**

11(A)	Explain the working of an optical absolute encoder. How the number of tracks and sectors of absolute encoder is related to the resolution of the encoder?	6	
11(B)	Explain the structure of a mechatronics system. How is it different from the traditional approach?	8	
OR			
12(A)	Explain the sensor characteristics to be considered when choosing a sensor for a mechatronics application	8	
12(B)	Compare the working of resolver and synchro	6	

Module II			
13(A)	Develop a pneumatic circuit with standard symbols, to operate two cylinders in sequence. Explain its working.	8	
13(B)	Explain the constructional features and working of brushless DC motor	6	
OR			
14(A)	Illustrate the working of Harmonic Drives with neat sketches	8	
14(B)	Design a hydraulic circuit to operate a winch fitted with a hydraulic motor. The motor should be run clockwise, counter clockwise and stopped. Use a manually operated valve.	6	
Module III			
15(A)	Draw and explain the block diagram of a feedback control system.	4	
15(B)	Develop a PLC ladder program for the following sequence: Start a motor with push switch, and then after a delay of 90s, start a pump. When the motor is switched off, the pump will get switched off after a delay of 5s. Mention the logic used for each rung in the program to substantiate your answer.	10	
OR			
16(A)	Explain how a PLC can be used to handle analog inputs?	4	
16(B)	Explain the model a fluid flow system with basic building blocks, clearly mention all assumptions	10	
Module IV			
17(A)	Explain the steps involved in photolithography. State the chemicals used in each of the stages along with the operating conditions	6	
17(B)	Compare and contrast various micro manufacturing techniques	8	
OR			
18(A)	Describe the various mechanical problems associated with surface micromachining	6	
18(B)	Explain the LIGA process associated with MEMS fabrication	8	
Module V			
19(A)	With the help of a neat sketch explain the different mechatronics modules used in automatic car park barrier system	10	

19(B)	List any four applications of robotic vision systems	4	
OR			
20(A)	Explain the working of Barcode reader with reference to the coding schemes. Mention the steps to process the digits in a barcode for a particular product. Develop the steps in a program for reading the barcode.	10	
20(B)	List the steps in thresholding technique in image processing	4	

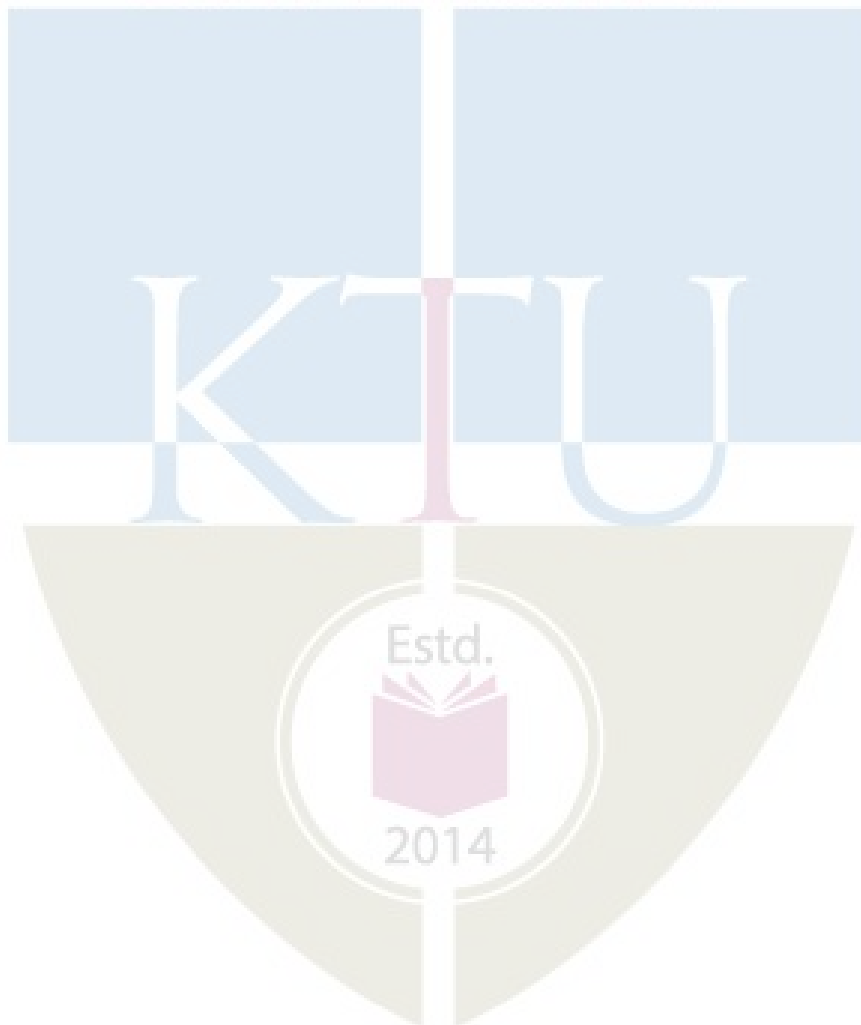

ECT428	OPTIMIZATION TECHNIQUES	CATEGORY	L	T	P	CREDIT
		PEC	2	1	0	3

Preamble: This course aims to provide a broad picture of various applications of optimization methods used in engineering.

Prerequisite: NIL

Course Outcomes: After the completion of the course the student will be able to

CO 1 K4	Formulate and classify different optimisation problems.
CO 2 K3	Apply classical and numerical methods solving linear and non-linear optimisation problems.
CO 3 K3	Apply modern methods of optimisation for solving optimisation problems.

Mapping of course outcomes with program outcomes

	PO 1	PO 2	PO 3	PO 4	PO 5	PO 6	PO 7	PO 8	PO 9	PO 10	PO 11	PO 12
CO 1	3	3										2
CO 2	3	3										2
CO 3	3	3										2

Assessment Pattern

Bloom's Category		Continuous Assessment Tests		End Semester Examination
		1	2	
Remember	K1	10	10	10
Understand	K2	20	20	20
Apply	K3	20	20	70
Analyse				
Evaluate				
Create				

Mark distribution

Total Marks	CIE	ESE	ESE Duration
150	50	100	3 hours

Continuous Internal Evaluation Pattern:

Attendance	: 10 marks
Continuous Assessment Test (2 numbers)	: 25 marks
Assignment/Quiz/Course project	: 15 marks

End Semester Examination Pattern: There will be two parts; Part A and Part B. Part A contain 10 questions with 2 questions from each module, having 3 marks for each question. Students should answer all questions. Part B contains 2 questions from each module of which student should answer any one. Each question can have maximum 2 sub-divisions and carry 14 marks.

Course Level Assessment Questions

Course Outcome 1 (CO1): Formulate optimisation problems. (K3)

1. Understand the different classification of optimization problems
2. Apply basic concepts of mathematics to formulate an optimization problem.
3. Formulation of real world problems as linear programming problems.

Course Outcome 2 (CO2) : Obtain optimised solution using classical methods for constrained and unconstrained problems. (K3)

1. Identify extreme points of a given function and classify as minimum, maximum or saddle point.
2. Formulate Lagrangian equation for constrained problems and solution using KKT conditions.
3. Find optimum solution using Simplex method for the given problem.

Course Outcome 2 (CO2): Obtain optimised solution using numerical methods for non-linear problems. (K3)

1. Apply elimination search and direct root methods for finding the optimal solution
2. Find optimal point of a given function using gradient methods.

Course Outcome 3 (CO3): (K3)

1. Explain different steps in the genetic algorithm.

2. Evaluate the strategies to be adopted for players using game theory.
3. Using algorithms find minimum spanning tree and shortest distance for given network path.
4. Two identical sections of the given networks are connected in parallel. Obtain the two port network parameters of the combination.

SYLLABUS

Module 1 : Introduction to classical method

Engineering applications of optimization, Formulation of design problems as mathematical programming problems.

Classification of optimization problems/techniques.

Classical optimization: unconstrained single and multivariable optimisation, Constrained optimization. Linear, Convex and non-convex optimization problems. KKT conditions.

Module 2 : Linear programming problems

Mathematical formulation of LP Problems, Solving using Simplex method and Graphical method

Module 3 :Game Theory, Network path models

Game Theory: Introduction, 2- person zero – sum game -Saddle point; Mini-Max and Maxi-Min Theorems (statement only)- Graphical solution ($2 \times n$, $m \times 2$ game), dominance property.

Introduction to network tree - Minimal Spanning Tree - Prim's Algorithm.

Shortest path problems- solution methods – Dijkstra's Method.

Module 4 : Nonlinear unconstrained optimization

Single variable optimization methods- Fibonacci search method, Newton Raphson method

Multi-variable methods- Hook-Jeeves pattern search method, Cauchy's (steepest descent) method

Module 5 : Modern methods of optimization

Introduction to Genetic algorithm, Basic GA framework

GA operators: Encoding, Crossover, Selection, Mutation

Introduction to Fuzzy logic. Fuzzy sets and membership functions. Operations on Fuzzy sets.

Optimization of Fuzzy Systems.

Text Books

1. S.S.Rao, Engineering Optimization.; Theory and Practice; Revised 3rd Edition, New Age International Publishers, New Delhi
- 2.H.A. Taha, " Operations Research", 5/e, Macmillan Publishing Company, 1992.
- Kanti Swarup, P.K.Gupta and Man Mohan, Operations Research, Sultan Chand and Sons

Reference Books

1. Kalynamoy Deb. “Optimization for Engineering Design- Algorithms and Examples”, Prentice-Hall of India Pvt. Ltd., New Delhi.
2. A. Ravindran, D. T. Phillips, J. J. Solberg, Operations Research – Principles and Practice, John Wiley and Sons.
3. Ashok D Belegundu, Tirupathi R Chandrupatla, “Optimization concepts and Application in Engineering”, Pearson Education.
4. Hadley, G. “Linear programming”, Narosa Publishing House, New Delhi
5. J. S. Arora, Introduction to Optimum Design, McGraw-Hill Book Company.

Course Contents and Lecture Schedule

No	Topic	No. of Lectures
1	Introduction:	
1.1	Engineering applications of optimization, Formulation of design problems as mathematical programming problems, objective function, constraints	1
1.2	Classification of optimization problems/techniques. Linear, convex, and non-convex.	2
1.3	Unconstrained optimization: Unconstrained one dimensional necessary and sufficient conditions for optimality	2
1.4	Algorithms for one-dimensional unconstrained optimization problem – Fibonacci, golden section	2
		7
2	Algorithms and Constrained Optimization	
2.1	Unconstrained multi-dimensional necessary and sufficient conditions for optimality	2
2.2	Algorithms for multi-dimensional unconstrained optimization problems – Steepest Descent, Newton’s methods	2
2.3	Constrained optimization: Lagrangian method - First order Necessary KKT Conditions, Second order sufficient conditions, Duality (Concept)	3
		7
3	Linear programming problems	
3.1	Mathematical formulation of LP Problems	1
3.2	Slack, surplus and artificial variables, Reduction of a LPP to the standard form, feasible solutions.	1
3.3	Graphical solution method	2
3.4	simplex algorithm and solution using tabular method,	1
3.5	optimality conditions and degeneracy	1
3.6	Duality in linear programming	1
		7

4	Nonlinear unconstrained optimization	
4.1	Single variable optimization methods- Fibonacci search method,	2
4.2	Newton Raphson method	2
4.3	Multi-variable methods- Hook-Jeeves pattern search method,	3
		7
5	Modern methods of optimization	
5.1	Introduction to Genetic algorithm, Basic GA framework	1
5.2	GA operators: Encoding, Crossover, Selection, Mutation	2
5.3	Introduction to Fuzzy logic.	1
5.4	Fuzzy sets and membership functions.	1
5.5	Operations on Fuzzy sets.	1
5.6	Optimization of Fuzzy Systems	1
		7

Simulation Assignments:

Atleast one assignment should be simulation of optimization Problems using MATLAB/ Scilab/ Python. The following simulations .

1. Find the solution of the linear programming problem using simplex method.

$$\text{Minimize } f = -x_1 - 2x_2 - x_3$$

subject to

$$2x_1 + x_2 - x_3 \leq 2$$

$$2x_1 - x_2 + 5x_3 \leq 6$$

Refer MATLAB Solution of LP Problems SS Rao.

- 2.

In an interval reduction problem, the initial interval is given to be 4.68 units. The final interval desired is 0.01 units. Find the number of interval reductions using Fibonacci method.

Ashok D. Belegundu, Tirupathi R. Chandrupatla

- 3.

Given $f = x_1^2 + 2x_2^2 + 2x_1x_2$, a point $\mathbf{x}^1 = (0.5, 1)^T$, with $f_1 \equiv f(\mathbf{x}^1) = 3.25$, apply the Hooke and Jeeves algorithm. Assume step $s = 1$, $r = 0.25$, $\varepsilon = 0.001$, $\alpha = 1$.

Ashok D. Belegundu, Tirupathi R. Chandrupatla

Model Question paper**APJ ABDUL KALAM TECHNOLOGICAL UNIVERSITY****EIGHTH SEMESTER B.TECH DEGREE EXAMINATION****Course Code: ECT428****Course Name: OPTIMIZATION TECHNIQUES**

Max. Marks: 100

Duration: 3 Hours

PART A

Answer ALL Questions. Each Carries 3 mark.

- 1 What are the necessary and sufficient conditions for the relative minimum of a function of a single variable? K2
- 2 Find the extreme points of the function K3

$$f(x_1, x_2) = x_1^3 + x_2^3 + 2x_1^2 + 4x_2^2 + 6$$
- 3 Give five typical applications of optimization techniques in engineering discipline. K1
- 4 What is the significance of gradient function in minimization problem? K2
- 5 State the duality principle and write the dual of the following LPP. K3
 Minimize $Z = 24x_1 + 30x_2$ subject to
 $2x_1 + 3x_2 \geq 10, 4x_1 + 9x_2 \geq 15, 6x_1 + 6x_2 \geq 20, x_1, x_2 \geq 0$
- 6 Write a short note on Dijkstra's shortest path algorithm K1
- 7 Explain the transformations needed to represent an LPP in standard form K1
- 8 State dominance property in game theory K1
- 9 Discuss membership function in fuzzy logic K2
- 10 Name and describe the main five features of Genetic Algorithm K2

PART – B

Answer one question from each module; each question carries 14 marks.

Module - I

- 11 a. Maximize $f(x) = 2x_1 + x_2 + 10$ subject to $x_1 + 2x_2^2 - 3 = 0$ 7

- b. Find the extreme points of the function K3
 $f(x_1, x_2, x_3) = x_1 + 2x_3 + x_2x_3 - x_1^2 - x_2^2 - x_3^2$. 7

K3

OR

- 12 Determine whether the following matrix is positive or negative definite. 7
 a. K3

$$A = \begin{pmatrix} 3 & 1 & -1 \\ 1 & 3 & -1 \\ -1 & -1 & 5 \end{pmatrix}$$

- b. Using method of Lagrange multipliers, Minimize $f(x_1, x_2, x_3) = x_1^2 + x_2^2 + x_3^2$ subject to constraints $4x_1 + x_2^2 + 2x_3 = 14$ 7

K3

Module - II

- 13 Solve the following LPP graphically, 14
 a. Minimize $Z = 20x_1 + 40x_2$

Subject to the constraints

$$36x_1 + 6x_2 \geq 108$$

$$3x_1 + 12x_2 \geq 36$$

$$20x_1 + 10x_2 \geq 100$$

$$\text{and } x_1, x_2 \geq 0$$

K3

OR

- 14 Solve the following LPP using simplex method. Maximize 14
 $Z = 10x_1 + 15x_2 + 20x_3$ subject to the constraints
 $2x_1 + 4x_2 + 6x_3 \leq 24, 3x_1 + 9x_2 + 6x_3 \leq 30, x_1, x_2, x_3 \geq 0$.

K3

Module - III

15 a. Solve the game using graphical method.

7

Player	B				
	2	-4	6	-3	5
A	2	-4	6	-3	5
A	-3	4	-4	1	0

K3

b. Using Dijkstra's method find the shortest path from node 1 to node 7 from the following network path model.

7

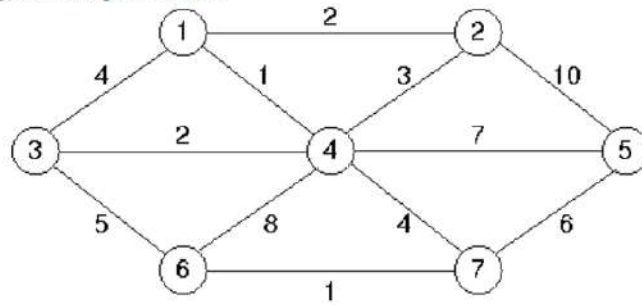

K3

OR

16 a. Using Prim's algorithm find the minimum spanning tree and the shortest distance from node 'a' to node 'b'.

7

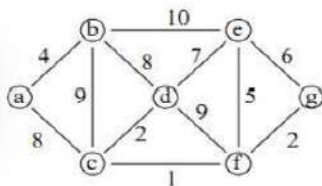

K3

b.

Solve the following payoff matrix using the graphical method.

	1	2	3	4	5
1	-5	5	0	-1	8
2	8	-4	-1	6	-5

- Find the optimal strategy for player A
- Find the optimal strategy for player B
- Value of the game
- Saddle point

7

K3

Module - IV

- 17 Solve the non linear unconstrained minimised optimisation problem by Hooke-Jeeves pattern search method by taking $\Delta x_1 = \Delta x_2 = 0.5$ and the starting point as $(x_1, x_2) = (2, -1)$ where $f(x_1, x_2) = x_1^2 + 3x_2^2 + 6x_1x_2 - x_1 - x_2$. 14
CO3
K3

OR

- 18 Using Fibonacci method, minimise $f = x^5 - 5x^3 - 20x + 5$ in the interval (0,5) in six steps. 14
K3

Module - V

19. Consider membership function of two fuzzy sets \tilde{A} and \tilde{B} are given by $\mu_{\tilde{A}}(x) = \frac{x}{x+2}$ and $\mu_{\tilde{B}}(x) = 3^{-x}$. Find the membership function of i) \tilde{A}^c ii) \tilde{B}^c , iii) $\tilde{A} \cup \tilde{B}$, iv) $\tilde{A} \cap \tilde{B}$, v) $(\tilde{A} \cup \tilde{B})^c$, where c is complement. 14
K3

OR

- 20 Consider the fuzzy relation R defined in A x A. Check whether the fuzzy relation is i) Reflexive, ii) Symmetric and iii) Transitive. 7

$$R = \begin{bmatrix} 0.4 & 0.1 & 0.7 \\ 0.1 & 0.2 & 0.2 \\ 0.4 & 0.5 & 0.3 \end{bmatrix}$$

K3

- b. Explain the working principles of Genetic Algorithms. 7,K2

ECT438	COMPUTER VISION	CATEGORY	L	T	P	CREDIT
		PEC	2	1	0	3

Preamble: This course aims to develop the knowledge of various methods, algorithms and applications of Computer Vision,

Prerequisite:Digital Image Processing

Course objectives:

- To review image processing techniques for computer vision
- To understand shape and region analysis
- To understand three-dimensional image analysis techniques and motion analysis
- To study some applications of computer vision algorithms
- To introduce methods and concepts which will enable the student to implement computer vision systems with emphasis on applications and problem solving

Course Outcomes: After the completion of the course the student will be able to

CO1	Understand digital filtering operations for CV applications.
CO 2	Apply basic morphological and boundary operators for Computer vision applications
CO3	Apply edge, corner detection algorithms to locate objects in an image.
CO 4	Apply optical flow algorithms to detect moving objects in a video.
CO5	Analyse a given scene using appropriate computer vision algorithms to detect/recognize objects and to implement it in real time practical applications.

Mapping of course outcomes with program outcomes

	PO 1	PO 2	PO 3	PO 4	PO 5	PO 6	PO 7	PO 8	PO 9	PO 10	PO 11	PO 12
CO 1	3	3	2		2						2	3
CO 2	3	3	2		2						2	3
CO 3	3	3	3		2						2	3
CO 4	3	3	3		2						2	3
CO 5	3	3	3		2						2	3

Assessment Pattern

Bloom's Category	Continuous Assessment Tests		End Semester Examination
	1	2	
Remember K1	10	10	10
Understand K2	10	10	20
Apply K3	20	20	70
Analyse K4	10	10	
Evaluate			
Create			

Mark distribution

Total Marks	CIE	ESE	ESE Duration
150	50	100	3 hours

Continuous Internal Evaluation Pattern:

Attendance	: 10 marks
Continuous Assessment Test (2 numbers)	: 25 marks
Assignment/Quiz/Course project)	: 15 marks

End Semester Examination Pattern: There will be two parts; Part A and Part B. Part A contain 10 questions with 2 questions from each module, having 3 marks for each question. Students should answer all questions. Part B contains 2 questions from each module of which student should answer any one. Each question can have maximum 2 sub-divisions and carry 14 marks.

Course Level Assessment Questions

Course Outcome 1 (CO1): Apply digital filtering operations for Computer vision applications

1. Why histogram transformations are applied in a grey scale image and what output is observed in that case.
2. Find filtered image using LP/HP/Smoothing/Median filter.
3. Describe the working principle of Homomorphic filter.
4. Role of thresholding in CV applications

Course Outcome 2 (CO2): Apply basic morphological and boundary operators for Computer vision applications

1. Apply various algorithms for morphological operations and binary shape analysis
2. List different morphological operators and describe about each one in detail.
3. To describe connected component labelling and to apply it in a given image pixel set.
4. Find 8-point connectivity and Chain code of a given image pixel diagram.

Course Outcome 3 (CO3): Apply edge, corner detection algorithms to locate objects in an image.

1. What is the role of edge detection and corner detection in Computer Vision applications?
2. Describe Canny's edge detection algorithm.
3. Mention the steps in Harris corner detection algorithm and explain how it is employed to detect corners in an image.
4. State with necessary mathematical steps, how Hough transform is employed for detecting lines and curves in detecting an image.

Course Outcome 4 (CO4): Apply optical flow algorithms to detect moving objects in a video.

1. To identify shapes from -X in Computer Vision applications?
2. Derive brightness constancy equation
3. Derive Horn-Shunk algorithm.
4. Illustrate the steps in Lucas-Kannade algorithm to detect optical flow.
5. To identify a structure from a moving object.

Course Outcome 5 (CO5): Analyse a given scene using appropriate computer vision algorithms to detect/recognize objects and to implement it in real time practical applications

1. Find Eigen values and Eigen Vectors of agiven square matrix

$$A = \begin{bmatrix} 9 & 4 & 0 \\ 4 & 3 & 0 \\ 0 & 0 & 0 \end{bmatrix}$$

2. To apply PCA for face recognition and face detection.
3. To apply SVM, LDA, Bayes rule and ML methods
4. Analyse a given video to track a moving object in it.
5. To detect a particular object from the background.
6. To detect signboards/ pedestrian crossings/pedestrians from a moving vehicle.
7. To classify/segment a particular set of image using CV algorithms.
8. Analyse a given image/video using Machine learning/Deep learning algorithms.
9. Use trained networks to analyse a video using ML algorithms.
10. To use Deep neural networks/CNN/YOLOvx, to analyse images/videos

SYLLABUS**Module 1**

Review of image processing techniques: Digital filters, linear filters-Homomorphic filtering, Point operators- Histogram, neighbourhood operators, thresholding

Module 2

Mathematical morphology, Binary shape analysis, Binary shape analysis, Erosion, Dilation, Opening and Closing, Hit-or-Miss Transform ,connectedness, object labelling and counting, Boundary descriptors – Chain codes. Properties of Binary Regions, Geometric Features, Statistical Shape Properties.

Module 3

Feature Detection and Image Synthesis, Edge detection – edges, lines, active contours, Split and merge, Mean shift and mode finding, Normalized cuts, Graph cuts, energy-based methods- Cranny's Algorithm, Corner detection, Harris corner detection algorithm. Hough transform-Line and curve detection.

Module 4

Shape from X - Shape from shading, Photometric stereo, Texture Occluding contour detection. Motion Analysis- Regularization theory, Optical Flow: brightness constancy equation, aperture problem, Horn-Shunck method, Lucas-Kanade method. Structure from motion

Module 5

Object recognition-Shape correspondence and shape matching PCA,SVM, LDA, Bayes rule and ML methods. Eigen faces, Face detection, Face recognition, Application: Scene analysis Examples of real time applications: In-vehicle vision system.

Text Books

1. E. R .Davies, Computer and Machine Vision -Theory Algorithm and Practicalities, Academic Press, 2012
2. Richard Szeliski, Computer Vision: Algorithms and Applications, ISBN 978-1-84882-935-0, Springer 2011.
3. David Forsyth and Jean Ponce, Computer Vision: A Modern Approach, Pearson India, 2002.

Reference Books

1. Goodfellow, Bengio, and Courville, Deep Learning, MIT Press, 2006.
2. Daniel Lelis Baggio, Khvedchenialevgen, Shervin Emam, David Millan Escriva, NaureenMahmoo, Jason Saragi, Roy Shilkrot, Mastering OpenCV with Practical Computer Vision Projects, Packt Publishing Limited, 2012
3. Simon J D Prince, Computer Vision: Models, Learning, and Inference, Cambridge University Press, 2012.
4. R. J. Schalkoff, Digital Image Processing and Computer Vision, John Wiley, 2004.
5. D. L. Baggio et al., —Mastering OpenCV with Practical Computer Vision Projects,

6. Jan Erik Solem, —Programming Computer Vision with Python: Tools and algorithms for analyzing images, O'Reilly Media, 2012.

Course Contents and Lecture Schedule

No.	Topic	No. of Lectures
1	Introduction	
1.1	Review of image processing techniques	1
1.2	Digital filters, Linear filtering-Homomorphic filtering	2
1.3	Point operators- Histogram, neighbourhood operators, Thesholding	2
2	Binary operations	
2.1	Erosion, Dilation, Opening and Closing, Hit-or-Miss Transform, structuring element	2
2.2	Binary shape analysis, Connected components- Connected component labelling, Boundary descriptors – Chain codes.	2
2.3	Properties of Binary Regions , Geometric Features ,Statistical Shape Properties	2
3	Feature Detection:	
3.1	Edge detection – edges, lines, active contours, Split and merge, Mean shift and mode finding, Normalized cuts, Graph cuts, energy-based method- Canny's edge detection Algorithm	2
3.2	Corner detection, Harris corner detection algorithm,	1
3.3	Hough transform Algorithm for Line and curve detection.	2
4	Motion Analysis	
4.1	Shape from X - Shape from shading, Photometric stereo, Texture	2
4.2	Motion Analysis- Regularization theory, Optical Flow: brightness constancy equation, aperture problem,	3
4.3	Horn-Shunck Algorithm and Lucas-Kanade Algorithm for detection of optical flow.	3
4.4	Structure from motion	2
5.	Applications of Computer Vision	
5.1	Object Detection and Object classification algorithms: SVM, PCA, Linear discriminant analysis, Bayes rule, ML methods.	3
5.2	Face detection, Face Recognition, Eigen faces, 3D face models	3
5.3	Applications of computer vision: Scene Analysis and scene understanding, Examples of real time applications: In-vehicle vision system	3

Simulation Assignments

The following simulations can be done in Open CV/SciLab/ MatLab

1. Design and implementation of basic digital filters.
2. Apply thresholding operations in a digital image.
3. Apply point operators in an image –averaging/smoothing, 2D- masks(3 types),
4. Apply morphological operations in a selected image like fingerprint/ archaeological scripts.
5. Implement filters in 2D-frequency domain using Gaussian/Homomorphic filters in a particular satellite image or forensic image.
6. Write algorithms for connected component labelling in a given image pixel set.
7. Detect a coin/ball against the background using background subtraction and with appropriate edge detection algorithms.
8. Locate iris from an image of human eye, using Hough transform algorithm.
9. Locate corners of a particular image like boxes/ building/TV screen etc
10. Write a program to implement brightness constancy equation.
11. Analyse the optical flow of a given video using Horn-Schunk method or/and Lucas-Kannade method/s.
12. Use PCA for dimensionality reduction in detecting faces using Eigen values.
13. Implement SVM/LDA for any practical application.
14. Apply ML/Bayes' rule for CV applications.
15. Create an attendance system by implementing face recognition method, among a set of students.
16. With OpenCV library, implement real time scene analysis for traffic regulation. (Cases such as detecting road signs/ pedestrians/track a particular vehicle/ detect traffic lights/detect number plate of a vehicle/ detect accidents/ accident scene analysis etc., etc.).
17. Use ML/DL algorithms to implement object detection/identification/classification, with trained neural networks for applications in medical/agricultural/sports fields.
18. Write algorithms for the gait analysis of a person with walking difficulty to monitor improvements in his daily activities.
19. Identify a person from his moving mannerisms, using Gait analysis.

20. Use gait analysis to monitor a sports person in any athletic/boxing/power lifting/any sports activity.

Model Question paper

APJ ABDUL KALAM TECHNOLOGICAL UNIVERSITY

EIGHTH SEMESTER B.TECH DEGREE EXAMINATION

Course Code: ECT438

Course Name: COMPUTER VISION

Max. Marks: 100

Duration: 3 Hours

PART A

Answer ALL Questions. Each carries 3 marks.

- | | | |
|----|---|----|
| 1 | Write down the Sobel, Robert and Prewitt masks | K1 |
| 2 | Give a 3x3 convolution mask to shift a 256x256 image one pixel position to right. | K2 |
| 3 | Name three computer vision applications where object labelling and counting is applied. | K2 |
| 4 | Describe steps in identifying connected components in an 8- connectivity case. | K2 |
| 5 | Write down basic Hough transform algorithm | K2 |
| 6 | Compare and contrast normalised cut and graph cut methods. | K2 |
| 7 | Mention the concept of identifying structure from motion. | K2 |
| 8 | Define texture? What is its role in object recognition? | K2 |
| 9 | Define Eigen values and Eigen vectors. | K2 |
| 10 | Differentiate between SVM and LDA. | K2 |

PART – B

Answer one question from each module; each question carries 14 marks.

Module - I

- | | | |
|-----|---|------------------|
| 11a | Describe point operators with illustrative diagrams. | (6)
CO1
K1 |
| 11b | What is linear filtering? Describe Homomorphic filtering. | (8)
CO1
K1 |

Module III

- 15 a Describe how Mean shift algorithm locate maxima of a density function in computer vision applications. (7)
CO3
K2
- 15 b Interpret different steps involved in Harris corner detection algorithm and describe how it is applied to detect corners in an image (7)
CO3
K3

OR

- 16a Give Canny's algorithm and describe how it can be applied to detect edges of an image. (7)
CO3
K3
- 16b Write down Hough Transform algorithm and explain how it can be employed to locate coins in a given image. (7)
CO3
K3

Module - IV

- 17a Give Lucas-Kannade algorithmic with each steps and explain how it is employed for motion detection. (6)
CO4
K3
- 17 b Briefly explain the following concepts (8)
CO4
K3
- (i) Photometric stereo
(ii) Shape from -X

OR

- 18 a. Derive brightness constancy equation. (6)
CO4
K3
- 18 b. Describe with algorithmic steps, the Horn-Shunk method used for the estimation of optical flow. (8)
CO4
K3

Module - V

- 19 a Describe how LDA is employed for dimensionality reduction, with different mathematical steps involved. (7)
CO5
K3
- 19 b Find Principal components of the following matrix (7)
CO5
K3

$$A = \begin{bmatrix} 8 & -8 & -2 \\ 4 & -3 & -2 \\ 3 & -4 & 1 \end{bmatrix}$$

OR

- 20 a What is an Eigen face? Derive the equation for Eigen faces and Explain its importance in a face recognition system. (7)
CO5
K3
- 20b. Illustrate the operation of an in-vehicle vision system, for locating roadways and pedestrians, as a real time practical application of computer vision. (7)
CO5
K3

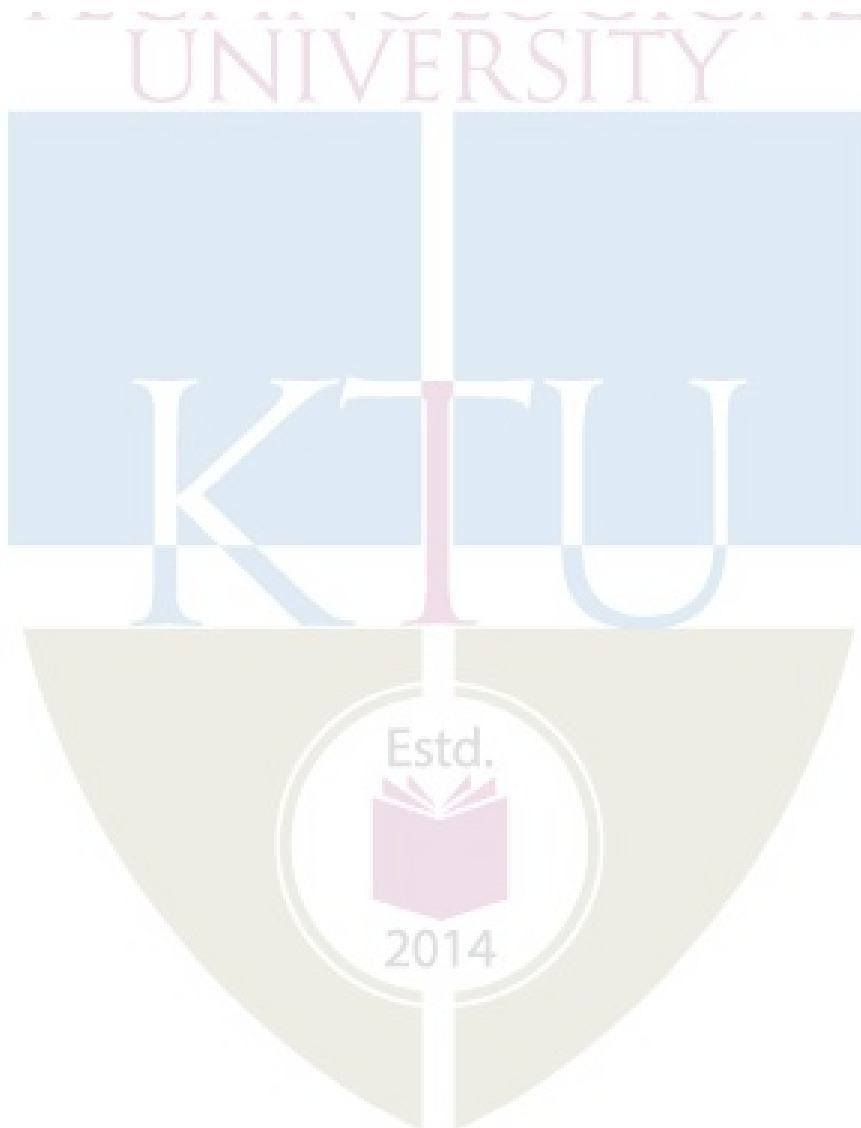

ECT448	LOW POWER VLSI	CATEGORY	L	T	P	CREDIT
		PEC	2	1	0	3

Preamble: This course aims to impart the basic knowledge in designing of Low power VLSI Circuits .

Prerequisite: Solid State Devices, VLSI Design, Digital Circuit Design.

Course Outcomes: After the completion of the course the student will be able to

CO 1	Identify various short channel effects and various sources of power dissipation in MOSFET
CO 2	Apply various power reduction techniques to circuits.
CO 3	Apply various clocked and non clocked design styles for logic implementation.
CO 4	Apply Adiabatic and reversible logic for circuit implementation.

Mapping of course outcomes with program outcomes

	PO 1	PO 2	PO 3	PO 4	PO 5	PO 6	PO 7	PO 8	PO 9	PO 10	PO 11	PO 12
CO 1	3	2										
CO 2	3	2										
CO 3	3		3		2							
CO 4	3		3									

Assessment Pattern

Bloom's Category	Continuous Assessment Tests		End Semester Examination
	1	2	
Remember	10	10	10
Understand	20	20	20
Apply	20	20	70
Analyse			
Evaluate			
Create			

Mark distribution

Total Marks	CIE	ESE	ESE Duration
150	50	100	3 hours

Continuous Internal Evaluation Pattern:

Attendance	: 10 marks
Continuous Assessment Test (2 numbers)	: 25 marks
Course project/Assignment	: 15 marks

End Semester Examination Pattern: There will be two parts; Part A and Part B. Part A contain 10 questions with 2 questions from each module, having 3 marks for each question. Students should answer all questions. Part B contains 2 questions from each module of which student should answer any one. Each question can have maximum 2 sub-divisions and carry 14 marks. Mark patterns are as per the syllabus with 60% for theory and 40% for logical/numerical problems, derivation and proof.

Course Level Assessment Questions

Course Outcome 1 (CO1): Identify various short channel effects and various sources of power dissipation in MOSFET

1. Derive the expression of switching power in static CMOS circuit.
2. Explain impact ionization and Hot electron effect.
3. Explain the various factors causing leakage power in MOSFET.

Course Outcome 2 (CO2): Apply various power reduction techniques to circuits.

1. Describe the use of transistor and Gate sizing for power deduction.
2. Describe supply voltage scaling method for power reduction.
3. Apply various power reduction schemes to memory cells..

Course Outcome 3 (CO3) : Apply various clocked and non clocked design styles for logic implementation

1. Implement XOR gate in domino logic.
2. Implement the function $F = [AB+CD]$ in DCVS.
3. Implement basic gates in nmos and pseudo nmos logic.

Course Outcome 4 (CO4): Apply Adiabatic and reversible logic for circuit implementation.

1. Implement $Y=AB$ using adiabatic logic
2. Explain one stage adiabatic buffer.
3. Implement logic functions using different Reversible logic structures.

Syllabus

Module 1: Physics of Power dissipation in MOSFET devices

Need for low power circuit design, MIS Structure, Short channel effects-surface scattering, punch through, velocity saturation, impact ionization Hot electron effects, Drain Induced Barrier Lowering, Deep submicron transistor design issues.

Module 2: Sources of power dissipation in CMOS-Dynamic Power Dissipation: Charging and Discharging capacitance power dissipation , Short Circuit Power: Short Circuit Current of Inverter , Short circuit current dependency with input and output load , Glitching Power, Static Power Dissipation, Leakage Power Dissipation, Gate level power analysis : Capacitive, internal and Static power dissipation of gate level circuit.

Module 3: Power Reduction Techniques :Supply voltage Scaling Approaches: Multi VDD and Dynamic VDD, leakage power reduction Techniques – Transistor stacking, VTCMOS,MTCMOS, DTCMOS, Power gating, Clock gating for Dynamic power dissipation, Transistor and Gate Sizing for Dynamic and Leakage Power Reduction.

Module 4: Circuit design style- clocked design style- Basic concept, Domino logic (domino NAND gate), Differential Current Switch Logic. Non clocked circuit design style-fully complementary logic. NMOS and pseudo –NMOS logic, differential cascade voltage switch logic(DCVS)

Module 5: Adiabatic switching – Adiabatic charging, adiabatic amplification, One stage and two stage adiabatic buffer, Adiabatic logic gates, pulsed power supplies, Reversible logic basic concepts.

Text Books:

1. Gray Yeap, Practical low power digital VLSI design, Springer, 1998
2. Kaushik Roy, Sharat C Prasad, Low power CMOS VLSI circuit design, Wiley India, 2000

References:

1. Abdellatif Bellaouar, Mohamed I Elmasry, Low power digital VLSI design, Kluwer Academic, 1995
2. Anatha P Chandrakasan, Robert W Brodersen, Low power digital CMOS Design, Kluwer Academic, 1995
3. Christian Piguet, Low power CMOS circuits, Taylor & Francis, 2006
4. Kiat Seng Yeo, Kaushik Roy, Low voltage, low power VLSI sub systems, Tata McGraw Hill, 2004

Course Contents and Lecture Schedule

No	Topic	No. of Lecture
1	Physics of Power dissipation in MOSFET devices	
1.1	Need for low power circuit design, MIS Structure.	2
1.2	Short channel effects-surface scattering, punch through, velocity saturation, impact ionization, Hot electron effects, Drain Induced Barrier Lowering.	3
1.3	Deep submicron transistor design issues.	1
2	Sources of power dissipation in CMOS	
2.1	Dynamic Power Dissipation: Charging and Discharging capacitance power dissipation	1
2.2	Short Circuit Power: Short Circuit Current of Inverter , Short circuit current dependency with input and output load .	2
2.3	Glitching Power, Static Power Dissipation, Leakage Power Dissipation,	4
2.4	Gate level power analysis : Capacitive, internal and Static power dissipation of gate level circuit.	2
3	Power Reduction Techniques	
3.1	Supply voltage Scaling Approaches: Multi VDD and Dynamic VDD	1
3.2	Leakage power reduction Techniques – Transistor stacking VTCMOS, MTCMOS, DTCMOS	2
3.3	Power gating, Clock gating for Dynamic power dissipation,	2
3.4	Transistor and Gate Sizing for Dynamic and Leakage Power Reduction	2
4	Circuit design style	
4.1	Clocked design style- Basic concept, Domino logic	2
4.2	Differential Current Switch Logic	1
4.3	Non clocked circuit design style -fully complementary logic. NMOS and pseudo –NMOS logic	2
4.4	Differential Cascade Voltage Switch logic(DCVS)	1
5	Adiabatic switching	
5.1	Adiabatic charging, adiabatic amplification,.	3

5.2	One stage and two stage adiabatic buffer	2
5.3	Adiabatic logic gates, pulsed power supplies	1
5.4	Reversible logic basic concepts..	1

Simulation Assignments

Atleast one assignment should be simulation based using any simulation software. It can be the design of a circuit in any one of the clocked or non clocked style and perform power analysis. Samples of simulation assignments are given below.

1. Implement NAND gate in conventional CMOS and domino logic and perform power analysis in each case.
2. Implement any sample logic function in DCVS.
3. Apply threshold voltage scaling method to a logic function implemented in conventional style and perform power analysis.

Model Question Paper

Model Question Paper

A P J Abdul Kalam Technological University

EIGHTH SEMESTER B.TECH DEGREE EXAMINATION

BRANCH: ELECTRONICS AND COMMUNICATION ENGINEERING

COURSE: ECT448 LOW POWER VLSI

Time: 3 Hrs

Max. Marks: 100

PART A

Answer All Questions

1. Define the terms (3)
 - a) DIBL
 - b) Velocity Saturation
2. Discuss the need for low power VLSI Design (3)
3. Explain the dependency of short circuit current with output load? (3)
4. Explain dynamic power dissipation? (3)
5. Describe leakage power reduction using MTCMOS (3)
6. Define Slack time of logic gate . (3)
7. List the advantages and Disadvantages of Clocked design. (3)
8. Explain the methods to overcome charge sharing problem. (3)
9. Draw the schematic and logic symbol of an Adiabatic amplifier.. (3)

10. List the disadvantages of Retractable cascade of Adiabatic logic Gates. (3)

PART B

Answer one question from each module. Each question carries 14 mark

Module I

- 11(A) Explain the energy band diagram of MIS structure. (8)
 11(B) Describe various transistor leakage mechanisms in deep submicron transistors. (6)

OR

- 12(A) Explain various short channel effects. (8)
 12(B) Explain how the power efficiency of a chip can be measured? (6)

Module II

- 13(A) Explain how capacitance can be estimated at gate level? (7)
 13(B) Explain the formation of glitches in circuits ? Explain various methods for eliminating the glitches (7)

OR

- 14(A) Explain the various sources of leakage power in MOSFET (7)
 14(B) A 16 bit bus operating in 5V and 66MHz clock rate is driving capacitance of 2pF/Bit. Each bit is estimated to have a toggling probability of 0.25 at each clock cycle. Calculate the power dissipated in operating the bus. (7)

Module III

- 15(A) Illustrate with examples how low threshold device and high threshold device can be effectively used for power reduction. (7)
 15(B) Explain dynamic supply voltage scaling mechanism for power reduction. (7)

OR

- 16(A) Briefly explain dynamic and leakage power reduction using transistor sizing. (7)
 16(B) Illustrate various mechanisms by which power consumption of 6T RAM cells can be reduced. (7)

Module IV

- 17(A) Implement the function $F = [(a+b)(c+d)]'$ in NMOS logic and domino logic. (7)
 17(B) Implement the function $F = (A+CD)$ in DCVS logic (7)

OR

- 18(A) Explain how charge sharing problem occur in logic design. How it can be eliminated? (7)
- 18(B) Differentiate precharge high and precharge low DCSL. (7)

Module V

- 19(A) Describe the working of one stage adiabatic buffer. (7)
- 19(B) Explain pulsed power supply? Describe its importance in adiabatic logic. (7)

OR

- 20(A) Describe various reversible gate structures. (7)
- 20(B) Implement OR and AND function using Fredkin gate. (7)

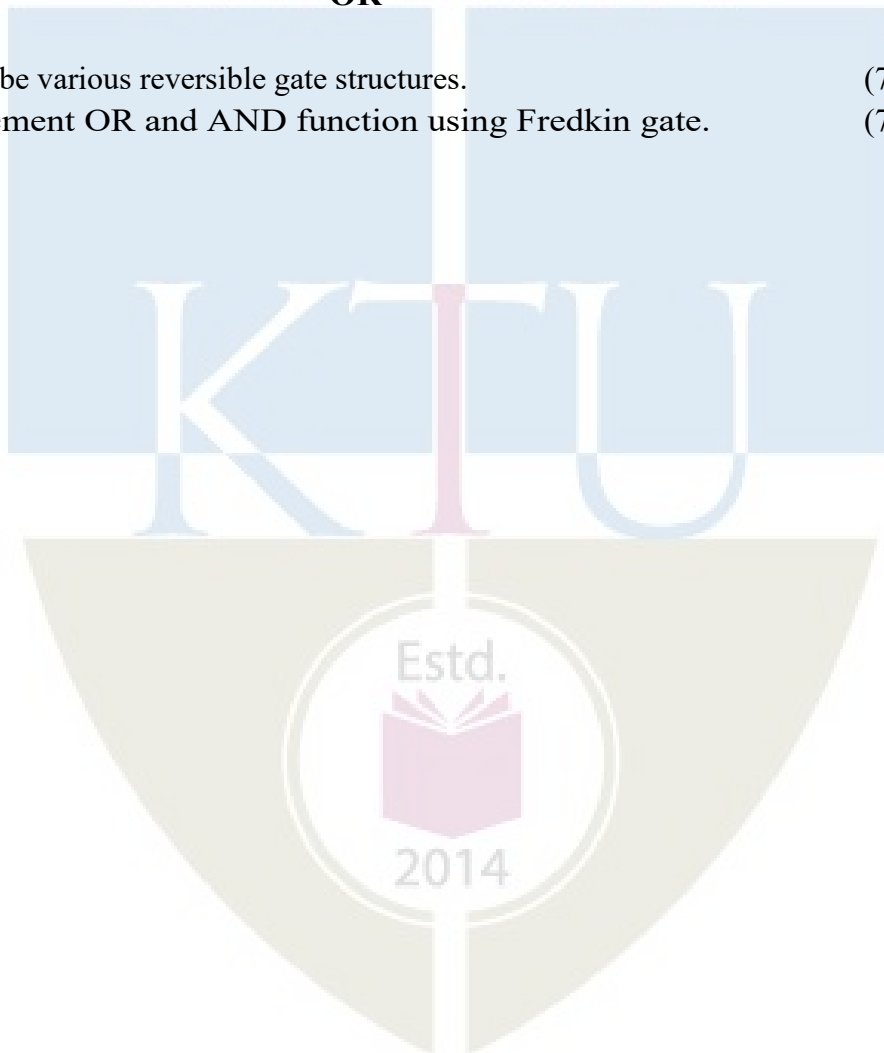

ECT458	INTERNET OF THINGS	CATEGORY	L	T	P	CREDIT
		OEC	2	1	0	3

Preamble: This course aims to develop skills in IoT system development and to apply the same in real life applications.

Prerequisite: ECT342 Embedded systems

Course Outcomes: After the completion of the course, a student will be able to

CO 1 K1	Understand the IoT fundamentals and architecture modelling (K1)
CO 2 K2	Understand the smart things in IoT and functional blocks (K2)
CO3 K2	To understand the communication networks and protocols used in IoT. (K2)
CO 4 K3	To understand the cloud resources, data analysis and applications. (K3)
CO5 K3	To apply the IoT processes in embedded applications. (K3)

Mapping of course outcomes with program outcomes

	PO 1	PO 2	PO 3	PO 4	PO 5	PO 6	PO 7	PO 8	PO 9	PO 10	PO 11	PO 12
CO 1	3	3	2		1			2				2
CO 2	3	3	3		3			2				2
CO 3	3	3	3		3			2	3			2

Assessment Pattern

Bloom's Category		Continuous Assessment Tests		End Semester Examination
		1	2	
Remember	K1	20	10	20
Understand	K2	30	20	40
Apply	K3	0	20	40
Analyse				

Evaluate			
Create			

Mark distribution

Total Marks	CIE	ESE	ESE Duration
150	50	100	3 hours

Continuous Internal Evaluation Pattern:

Attendance	: 10 marks
Continuous Assessment Test (2 numbers)	: 25 marks
Assignment/Quiz/Course project	: 15 marks

End Semester Examination Pattern: There will be two parts; Part A and Part B. Part A contain 10 questions with 2 questions from each module, having 3 marks for each question. Students should answer all questions. Part B contains 2 questions from each module of which student should answer any one. Each question can have maximum 2 sub-divisions and carry 14 marks.

Course Level Assessment Questions

Course Outcome 1 (CO1): Understand the IoT fundamentals and architecture modelling (K1)

1. What is the definition of IoT and different characteristics of IoT
2. Define the architectural view of IoT and functional blocks
3. What are the different levels of IoT

Course Outcome 2 (CO2): Understand the smart things in IoT and functional blocks (K2)

1. What are the different smart things in IoT
2. How the communication is established among nodes and nodes and cloud.
3. What are the protocols that are used in IoT

Course Outcome 3 (CO3): To understand the communication networks and protocols used in IoT. (K2)

1. Differentiate between IEEE standard protocols
2. Explain the advantages of next generation IP based protocols used in IoT
3. Define different layers used in embedded protocols

Course Outcome 4 (CO4): To understand the cloud resources, data analysis and applications. (K3)

1. Explain how data is stored in IoT environment and processed
2. How to use cloud resources and different options available
3. How end devices can be used to control input and output devices

Course Outcome 5 (CO5): To apply the IoT processes in embedded applications. (K3)

1. What are the security and privacy concerns of IoT
2. Explain the typical applications of IoT.
3. Describe the processes involved in implementing a smart city.

SYLLABUS

Module 1 (7 Hours)

Introduction to IoT technology: Definitions and Characteristics of IoT, IoT Architectural View, Physical Design of IOT, Logical Design of IoT- IoT Functional blocks, IoT communication models, IoT Enabling Technologies, IoT Levels & Deployment Templates.

Module 2 (7 Hours)

IoT and M2M- M2M, Difference between IoT and M2M, SDN and NFV for IoT, Smart Objects: The “Things” in IoT: Sensors, Actuators, and Smart Objects, Sensor Networks- Wireless Sensor Networks (WSNs), Communication Protocols for Wireless Sensor Networks- Connecting Smart Objects- Communication Criteria.

Module 3 (7 Hours)

Unified Data Standards –Protocols –IEEE 802.15.4 -The Physical Layer, The Media-Access Control Layer, Uses of 802.15.4 ,The Future of 802.15.4: 802.15.4e and 802.15.4g–Modbus– ZigBee-Zigbee Architecture- LoRaWAN -Standardization and Alliances, Physical Layer, MAC Layer, Topology, LTE-M, NB-IoT-Network layer –The next generation: IP-based protocols - 6LoWPAN and RPL, Overview of the 6LoWPAN Adaptation Layer .

Module 4 (9 hours)

Data Collection, storage and computing Using a Cloud Platform-Introduction, Cloud Computing Paradigm for Data Collection, Storage and Computing-Cloud Computing Paradigm, Cloud Deployment Models-Everything as a Service and Cloud Service Models-SaaS, PaaS, IaaS, DaaS. Cloud based platforms-XIVELY, NIMBITS.

IoT Physical Devices & Endpoints-IoT Device-Building blocks –Raspberry-Pi -Board-Linux on Raspberry-Pi-Raspberry-Pi Interfaces (serial, SPI, I2C). Raspberry Pi interfacing and programming examples using python (LED, switch, sensor, serial, SPI, I2C devices). Controlling GPIO outputs and displaying sensor readings using web interface/cloud (Python programming is required only for assignments and projects and not for examinations. Other end nodes and platforms can also be used).

Module 5 (6 Hours)

IoT privacy, security and vulnerabilities solutions, vulnerabilities, security requirements, threat analysis, security tomography, layered attacker model, Identity management, access control, secure message communication.

Smart and Connected Cities-An IoT Strategy for Smarter Cities-Vertical IoT Needs for Smarter Cities, Global vs. Siloed Strategies-Smart City IoT Architecture-Street Layer, City Layer, Data Center Layer, Services Layer- Smart City Security Architecture - Smart City Use-Case Examples – Street lighting, smart parking, smart traffic and air pollution monitoring

Maximum 35 /36 Hours

Text Books

1. Vijay Madiseti and ArshdeepBahga, “Internet of Things (A Hands-on- Approach)”, 1st Edition, VPT, 2014 (Module1,2,4)
2. David Hanes, Gonzalo Salgueiro, Patrick Grossetete, Rob Barton and Jerome Henry, —IoT Fundamentals: Networking Technologies, Protocols and Use Cases for Internet of Things, Cisco Press, 2017. (Module2,3,5)
3. Rajkamal, “Internet of Things : Architecture and Design Principles”, McGraw Hill (India) Private Limited.
4. Raspberry Pi Cookbook, Software and Hardware Problems and solutions, SimonMonk, O'Reilly (SPD), 2016, ISBN.

Reference Books/Papers

1. Olivier Hersent, David Boswarthick, Omar Elloumi , “The Internet of Things –Key applications and Protocols”, Wiley, 2012 (Module 3)
2. Al-Fuqaha et al. Internet of things: A survey on enabling technologies, protocols, and applications. *IEEE Communications Surveys & Tutorials* (2015), pp. 2347- 2376.
3. The Internet of Things (The MIT Press Essential Knowledge series) Paperback – March 20, 2015 by SamuelGreengard
4. The Internet of Things: Converging Technologies for Smart Environments and Integrated Ecosystems, OviduVermesan and Peter Friess, RiverPublishers.
5. Internet of Things - From Research and Innovation to Market Deployment-RIVER PUBLISHERS, PETER FRIESS, OVIDIU VERMESAN (Editors)
6. Internet of Things Security and Data Protection, Sébastien Ziegler, Springer International Publishing 2019.

Course Contents and Lecture Schedule

No	Topic	No. of Lectures
1	Introduction to Internet of Things- 7Hrs	
1.1	Introduction, definition and characteristics	1
1.2	IoT architectural view, functional blocks	2
1.3	IoT Communication models, enabling technologies	2
1.4	IoT deployment levels	2
2	Essential components of IoT- 7Hrs	
2.1	IoT and M2M	2
2.2	Smart objects	2
2.3	Wireless sensor networks	3
3	IoT protocols- 7Hrs	
3.1	IEEE 802.15.4 protocols	2
3.2	Zigbee	1
3.3	6LoWPAN and RPL	2
3.4	LoraWAN, LTE-M and NB-IoT	2
4	Cloud storage and Programming the end device- 9Hrs	
4.1	Data storage and computation	3
4.2	Physical devices and end points	2
4.3	Raspberry pi programming	4
5	Security and Applications-6 Hrs	
5.1	Security and Privacy	2
5.2	Smart city application	2
5.3	Use case examples	2

Simulation Assignments:

- At least one assignment should be programming examples (python or any other language) using Raspberry pi (Other options like arduino, node mcu etc. can also be used) Include I/O interfacing, SPI, I2C, serial, sensor interfacing and web interface.
- Another assignment shall be an IoT system implementation of mini project consisting of a sensor, processing device, communication device and cloud storage (This can be individual or group projects). Mini project is essential for understanding the concepts of IoT.
- Mini project can be done in the following areas.
 - Smart city
 - Weather monitoring system
 - air pollution monitoring
 - Smart parking
 - smart traffic
 - any other application/s where sensors/actuators devices are used.

4. Programming and mini project are essential for understanding the concepts of IoT.

Model Question Paper

APJ ABDUL KALAM TECHNOLOGICAL UNIVERSITY

EIGHTH SEMESTER B.TECH DEGREE EXAMINATION

(Model Question Paper)

Course Code: ECT458

Course Name: INTERNET OF THINGS

Max. Marks: 100

Duration: 3 Hours

PART A

(Answer for all questions. Each Question Carries 3 marks)

1. List any five characteristics of IoT
2. What are the IoT enabling technologies?
3. What is a wireless sensor network?
4. What are the limitations of smart objects in WSNs??
5. Explain the need for IP optimization in IoTs?
6. What are the transmission modes used in modbus?
7. What are the 4 different cloud deployment models? Explain
8. What is cloud computing? Explain.
9. List the five functional units of security
10. What is message integrity? How it is checked? [10 X 3 = 30 Marks]

PART – B

(Answer one question from each module; each question carries 14 Marks)

Module – I

11. (a) Write a note on physical design of IoT. [06 Marks]
- (b) Give a detailed description of the link layer, network layer, transport layer and application layer protocols. [08 Marks]

OR

12. (a) What are the functional blocks of IoT? Explain? [07 Marks]
- (b) Discuss different communication models used in IoT. [07 Marks]

Module – II

13. (a) What are the differences between IoT and M2M? [07 Marks]
- (b) What are the issues of conventional networking architectures? How is it solved in SDN? [07 Marks]

OR

14. (a) What are smart objects? What are their characteristics and the trends in smart objects? [07 Marks]
 (b) What are the characteristics and attributes to be considered for connecting smart objects? [07 Marks]

Module – III

15. (a) Explain IEEE 802.15.4 physical layer, MAC layer and security implementation with the help of frame formats. [09 Marks]
 (b) What are the modifications included in IEEE 802.15.4 e and g versions as compared to IEEE 802.15.4? [05 Marks]

OR

16. (a) With the help of a diagram explain the Zigbee protocol architecture. [07 Marks]
 (b) Explain LoraWAN architecture. Give a detailed description of the physical layer and MAC layer of LoraWAN [07 Marks]

Module – IV

17. (a) Write a note on different cloud service models [06 Marks]
 (b) What is virtualization in cloud computing? Explain the features, advantages and concerns of cloud computing. [08 Marks]

OR

18. (a) With the help of a diagram explain the basic building blocks of an IoT device [07 Marks]
 (b) Explain cloud based data collection, storage and computing services provided by XIVELY cloud platform. [07 Marks]

Module – V

19. (a) What is security and Privacy? List the 10 vulnerabilities of IoT. [07 Marks]
 (b) Explain the layered attacker model. [07 Marks]

OR

20. (a) With the help of a diagram explain the 4 layer smart city architecture. [07 Marks]
 (b) Write a note on street lighting architecture with the help of a diagram [07 Marks]

ECT468	RENEWABLE ENERGY SYSTEMS	CATEGORY	L	T	P	CREDIT
		PEC	2	1	0	3

Preamble: This course helps the students to understand environmental issues with conventional fuels, the new methodologies/technologies for the effective utilization of renewable energy sources. They will be conversant with the characteristics of solar PV and wind power sources. Also, they will have an in-depth understanding of electronic conversion systems application to renewable energy generation systems and the synchronization with smart grid systems. The courses equip the students to pursue further specialized areas of study such as renewable energy and green consumer electronics, industrial control systems and smart grid, and renewable energy system which are essentially based on this course.

Prerequisite: Nil

Course Outcomes - After the completion of the course the student will be able to

CO1	Understand the need, importance and scope of various Non-Conventional sources of energy
CO2	Outline the concepts and technologies related to renewable energy systems using wind and Solar-PV
CO3	Understand the integration of smart grid with renewable energy systems
CO4	Explain the concept of distribution management system.
CO5	Describe the fundamentals of Smart metering

Mapping of course outcomes with program outcomes

	PO1	PO2	PO3	PO4	PO5	PO6	PO7	PO8	PO9	PO10	PO11	PO12
CO1	2						2					1
CO2	2											
CO3	2		1									
CO4	2											
CO5	3											

Assessment Pattern

Bloom's taxonomy	Continuous Assessment Tests		End Semester Examination (Marks)
	Test I (Marks)	Test II (Marks)	
Remember	10	10	20
Understand	30	30	60
Apply	10	10	20
Analyse			
Evaluate			
Create			

Mark distribution

Total Marks	CIE	ESE	ESE Duration
150	50	100	3 hours

Continuous Internal Evaluation (CIE) Pattern:

Attendance	10 marks
Regular class work/tutorials/assignments	15 marks
Continuous Assessment Test (Minimum 2 numbers)	25 marks

End semester pattern:-There will be two parts; Part A and Part B. Part A contain 10 questions with 2 questions from each module, having 3 marks for each question. Students should answer all questions. Part B contains 2 questions from each module of which student should answer any one. Each question can have maximum 2 subdivisions and carry 14 marks.

Course Level Assessment Questions**Course Outcome 1**

1. Describe the energy scenario in India. What are the various non-conventional energy resources relevant to India?
2. Explain how current scenario of world energy consumption leads to the exploitation of renewable energy sources.

Course Outcome 2

1. Explain grid connected solar PV systems with block diagram.
2. Explain solar power extraction using PV-Cells.

Course Outcome 3

1. Describe the sources and potentials of wind energy power system in India?
2. Give the classification of wind turbines and explain it with neat sketches?

Course Outcome 4

1. Draw and explain intelligent islanding detection techniques.
2. Explain the influence of WECS on system transient response

Course Outcome 5

1. Give the classification of SCADA system and what is its application in industry.
2. Draw and explain a smart meter

SYLLABUS**Module I**

Introduction to Renewable Energy (RE) Sources: World energy scenario, Over view of conventional energy sources, their limitation, need of renewable energy, potential & development of renewable energy sources, Renewable energy in India, An overview of types of renewable energy systems - Wind power, Hydropower (micro and mini), Solar energy, Biomass, Bio-fuel, Geothermal Heat energy, Pros and cons; Applications.

Module II

Solar Energy: Introduction to photovoltaic (PV) systems - Principle of PV conversion; Commercial solar cell, Thin film PV device fabrication - LPCVD, APCVD, PECVD; Tandem Solar cell fabrication; Solar power extraction using PV-Cells, I-V Characteristics, PV-Inverters without D.C. to D.C. converters, stand alone and grid collected PV systems, Grid interfacing-with isolation, without isolation, Maximum power point tracking-Methods(MPPT), PV-Inverters with D.C. to D.C. converters-on low frequency side and high frequency side with isolation, without isolation.

Module III

Wind Energy: Sources and potentials, Evaluation of Wind Intensity, Topography, General Classification of Wind Turbines-Rotor Turbines, Multiple-Blade Turbines, Drag Turbines, Lifting Turbines, System Toroidal Rotor Amplifier Platform (TARP)–Wind amplified rotor platform (WARP), Generators and speed control used in wind power energy: Fixed speed with capacitor bank, Rotor resistance control, SCIG and DFIG, Synchronous Generator-external magnetized, Synchronous Generator-permanent magnets.

Module IV

Electronic conversion systems application to renewable energy generation systems: Basic schemes and functional advantages, Power control and management systems for grid integration, island detection systems, synchronizing with the grid; Issues in integration of converter based sources; Network voltage management; Power quality management and Frequency management; Influence of PV/WECS on system transient response

Module V

Introduction to grid connectivity of RE systems, smart grid and emerging technologies, operating principles and models of smart grid components, key technologies for generation, networks, loads and their control capabilities; Evolution of electricity metering, key components of smart metering, overview of the hardware used for smart meters, smart metering protocols. Structure and main components of a distribution management system, Supervisory control and data acquisition (SCADA), distribution system modelling, new trends for smart grids, topology analysis, power flow analysis.

Text books:

1. Nayak J. K. and Sukhatme S. P. (2006), Solar Energy: Principles of Thermal Collection and Storage, Tata McGraw Hill.
2. Muhannad H. R. (2004); Power Electronics: Circuits, Devices and Applications, Pearson Prentice Hall.
3. Nick Jenkins, JanakaEkanayake, [et al.] Smart Grid Technology and Applications, Wiley India Ltd.
4. Ali Keyhani, Design of Smart Power Grid Renewable Energy Systems, Wiley-IEEE Press 2016.

Suggested Readings:

1. Non-Conventional Energy Sources /G.D. Rai
2. Renewable Energy Technologies /Ramesh & Kumar /Narosa
3. Integration of alternative sources of energy /Felix A. Farret, M. Godoy simoes
4. Wind power plants and projects developments, Joshua Earnest and T Wizelius, PHI, New Delhi, 2011.
5. Handbook of renewable energy technology, World Scientific, Singapore, 2011.
6. Garg H. P. and Prakash S. (2000); Solar Energy: Fundamental and Application, Tata McGraw Hill
7. Goswami D. Y. (2015); Principles of Solar Engineering, Taylor and Francis
8. Gellings C. W. (2009); The Smart Grid: Enabling Energy Efficiency and Demand Response, First Edition, CRC Press
9. Teodorescu R. Liserre M. Rodriguez P. (2011); Grid Converters for Photovoltaic and Wind Power Systems, First Edition, Wiley-IEEE Press
10. Ali Keyhani, Muhammad Marwali, *Smart Power Grids 2011*, Springer-Verlag Berlin Heidelberg 2012.

Course Contents And Lecture Schedule

SI No.	Topic	No. of lectures
1	Module 1:Introduction to Renewable Energy (RE) Sources	7
1.1	World energy scenario, Over view of conventional energy sources, their limitation	1
1.2	Over view of conventional energy sources, their limitation,	1
1.3	need of renewable energy, need, potential & development of renewable energy sources, Renewable Energy in India	1
1.4	An overview of types of renewable energy systems	1
1.5	Wind power, Hydropower (micro and mini)	1
1.6	Solar energy, Biomass, Bio-fuel, Geothermal Heat energy	1
1.7	Pros and cons; Applications	1

2	Module 2:Solar Energy	8
2.1	Introduction to photovoltaic (PV) systems and Principle of PV conversion	1
2.2	Commercial solar cell, Tandem Solar cell fabrication	1
2.3	Solar power extraction using PV-Cells	1
2.4	PV-Inverters without D.C. to D.C. converters	1
2.5	Stand alone and grid collected PV systems	1
2.6	Grid interfacing-with isolation, without isolation	1
2.7	Maximum power point tracking-Methods	1
2.8	PV-Inverters with D.C. to D.C. converters-on low frequency side and high frequency side with isolation, without isolation.	1
3	Module 3: Wind energy	6
3.1	Wind energy: Sources and potentials, Evaluation of Wind Intensity, Topography	1
3.2	General Classification of Wind Turbines-Rotor Turbines, Multiple-Blade Turbines, Drag Turbines, Lifting Turbines	1
3.3	Toroidal Rotor Amplifier Platform (TARP)- Wind amplified rotor platform (WARP)	1
3.4	Introduction: Generators used in wind power energy	1
3.5	SCIG, DFIG, Synchronous Generator-external magnetized, Synchronous Generator-permanent magnets	1
3.6	Speed control used in wind power energy, Fixed speed with capacitor bank, Rotor resistance control,	1
4	Module 4:Electronic conversion systems	6
4.1	Electronic conversion systems application to renewable energy generation systems, Basic schemes and functional advantages	1
4.2	Power control and management systems for grid integration, island detection systems, synchronizing with the grid	1
4.3	Issues in integration of converter based sources	1
4.4	Network voltage management	1
4.5	Power quality management and Frequency management	1
4.6	Influence of PV/WECS on system transient response	1
5	Module 5:Grid connectivity of RE systems	8
5.1	Introduction to grid connectivity of RE systems, Emerging technologies, operating principles and models of smart grid	1

5.2	Key technologies for generation, networks, loads and their control capabilities	1
5.3	Evolution of electricity metering, key components of smart metering,	1
5.4	An overview of the hardware used for smart meters, smart metering protocols.	1
5.5	Structure and main components of a distribution management system	1
5.6	Supervisory control and data acquisition (SCADA)	1
5.7	Distribution system modelling	1
5.8	New trends for smart grids, topology analysis, power flow analysis.	1

Model Question Paper

APJ ABDUL KALAM TECHNOLOGICAL UNIVERSITY
EIGHTH SEMESTER B.TECH DEGREE EXAMINATION
Course Code: ECT468
Course Name: Renewable Energy Systems

Max. Marks:100

Duration: 3 Hours

PART – A**(ANSWER ALL QUESTIONS, EACH QUESTION CARRIES 3 MARKS)**

1. Explain the present status of various modes of renewable power generations in India?
2. List the merits and de-merits of non-conventional energy resources
3. Explain the principle and working of photo voltaic system.
4. Explain any one method for maximum power point tracking for solar energy system.
5. Draw the basic block diagram of a wind energy conversion system.
6. Explain the principle of DFIG?
7. Discuss the main issues involved with power qualities?
8. Discuss the issues in connecting renewable energy systems to the grid?
9. Describe the future of smart grid.
10. Discuss the distribution management system in power system.

PART – B**(ANSWER ONE FULL QUESTION FROM EACH MODULE)****MODULE – 1**

11. a) Explain with a neat sketch, the working of hydropower plant system. (7 marks)
- b) List out various types of Biomass resources and the applications of biofuels? (7 marks)

OR

12. a) Briefly explain the energy resources in India (7 marks)
- b) Explain how current scenario of world energy consumption leads to the exploitation of renewable energy sources? (7 marks)

MODULE – 2

13. a) Draw and explain the VI characteristics of a solar cell. How does temperature affect the performance of solar cell? (7 marks)
- b) Explain stand-alone and grid connected solar PV systems? Explain each type with the help of block diagram and bring out their relative merits. (7 marks)

OR

14. a) Explain single crystal silicon and tandem solar cell with neat sketches. (7 marks)
- b) Explain the PV invertors with DC – DC converters on high frequency side with isolation. (7 marks)

MODULE – 3

15. a) Explain the stand alone operation of a fixed speed wind energy conversion system with a neat diagram. (7 marks)
- b) Classify the WECS based on the rotational speed of turbines (7 marks)

OR

16. a) Differentiate between TARP –WARP systems. (7 marks)
- b) Give the classification of wind turbines. Explain with neat sketches. (7 marks)

MODULE – 4

17. a) Explain the key issue in generation, integration and control of off shore wind energy conversion systems. (7 marks)
- b) What are the problems that occur while integrating renewable energy source in DC – DC converter? (7 marks)

OR

18. a) Give the classification of island detection systems. With a neat diagram explain intelligent islanding detection techniques. (7 marks)
- b) Explain the transient stability analysis of PV system with shading effects. (7 marks)

MODULE – 5

19. a) With a neat block diagram explain a smart meter (7 marks)
- b) Explain the power flow analysis in power system. (7 marks)

OR

20. a) Describe the open control SCADA network architecture. (7 marks)
- b) List the challenges and emerging technologies of smart grid (7 marks)

APJ ABDUL KALAM
TECHNOLOGICAL
UNIVERSITY

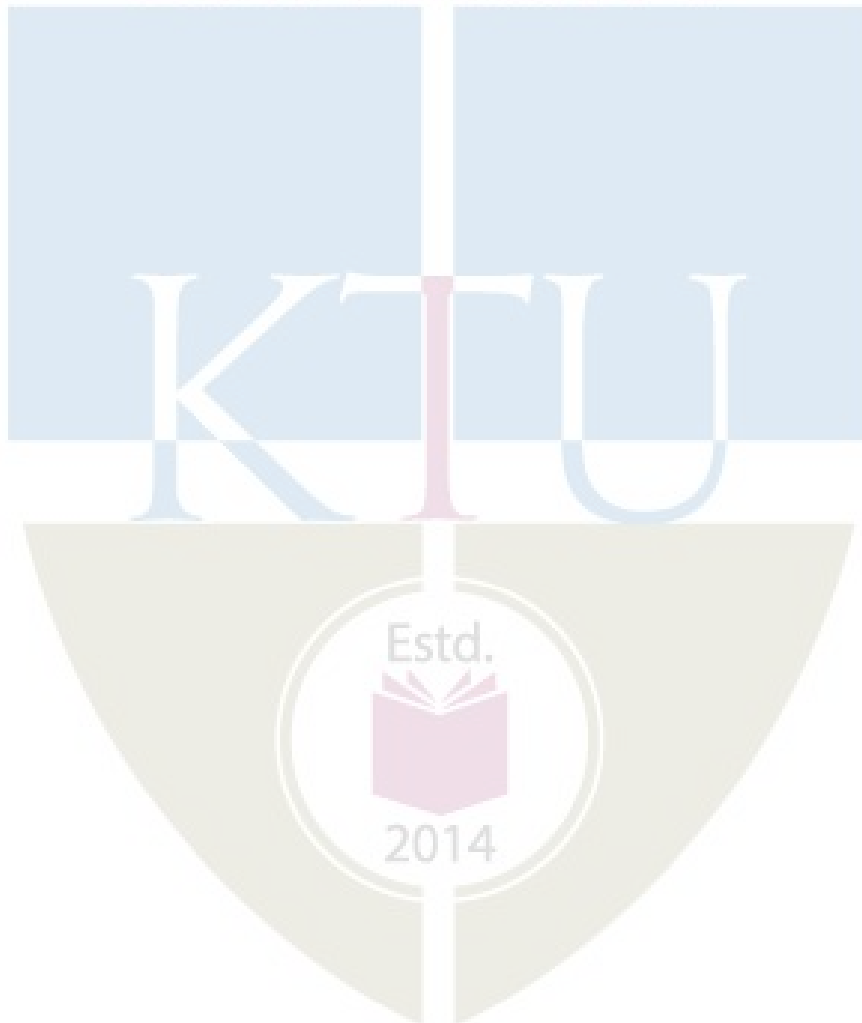

ECT478	ORGANIC ELECTRONICS	CATEGORY	L	T	P	CREDIT
		PEC	2	1	0	3

Preamble: This course aims to impart the basic knowledge in organic electronics.

Prerequisite: Solid State Devices

Course Outcomes: After the completion of the course the student will be able to

CO 1	Describe the principle of charge transport in organic semiconductors.
CO 2	Explain the structure and working of multilayer OLEDs, OFETs and OPVs
CO 3	Distinguish the action of different layers used in organic devices with reference to the materials used.
CO 4	Explain different techniques employed in making organic electronic devices like OLEDs, OPVs and OFETs

Mapping of course outcomes with program outcomes

	PO 1	PO 2	PO 3	PO 4	PO 5	PO 6	PO 7	PO 8	PO 9	PO 10	PO 11	PO 12
CO 1	3	3										
CO 2	3	3										
CO 3	3	3										
CO 4	3	3										

Assessment Pattern

Bloom's Category	Continuous Assessment Tests		End Semester Examination
	1	2	
Remember	10	10	20
Understand	30	30	60
Apply	10	10	20
Analyse			
Evaluate			
Create			

Mark distribution

Total Marks	CIE	ESE	ESE Duration
150	50	100	3 hours

Continuous Internal Evaluation Pattern:

Attendance : 10 marks

Continuous Assessment Test(2numbers: 25 marks

Course project/Assignment : 15 marks

End Semester Examination Pattern: There will be two parts; Part A and Part B. Part A contain 10 questions with 2 questions from each module, having 3 marks for each question. Students should answer all questions. Part B contains 2 questions from each module of which student should answer any one. Each question can have maximum 2 subdivisions and carry 14 marks. Mark patterns are as per the syllabus with 50% for theory and 50% for logical/numerical problems, derivation and proof.

Course Level Assessment Questions

CO-1

- 1.Explain the HOMO and LUMO and correlate with similar terms in inorganic semiconductors.
- 2.Discuss how soliton causes transport of charges in conjugated polymers

CO-2

- 1.Explain the construction and working of bilayer OLEDs.
- 2.With the help of energy band diagram, explain why work function matching is required between hole transport layer and emissive layer in PLEDs.
- 3.Describe the working mechanism of organic FET with relevant diagrams.

CO-3

- 1.Explain the importance of buffer layers in organic electronic devices.
- 2.Discuss the features of ITO and also its effect on the performance of organic electronic devices.
- 3.Explain the different methods by which the efficiency of the organic electronics devices can be improved.

CO-4

- 1.Compare the vapor deposition and spin coating methods.
- 2.Explain the screen printing technique.
- 3.Describe the RF and microwave plasma assisted coating method.
- 4.Distinguish between doctor blading and ink jet printing methods.

Syllabus

Module 1

Conducting polymer, Organic semiconductor, conduction mechanism, Pi and Sigma electron bandtheory. Polymers fundamentals-conducting polymers. Organic semiconductors, charge transport in conjugated polymers. Conduction mechanism in doped polymeric semiconductors. Physics of organic semiconductors (Luminescence, injection and transports properties)Methods of developing organic semiconductors.

Module 2

Basic device architecture in organic devices. Historical review. Organic light emitting diodes(OLED) and Polymer light emitting diodes (PLED). Multilayer architecture. Single layer architecture. Bulk hetero-junctions. Operating characteristics and electrical characterization. Flexible electronics : new display media. Flexible displays device architecture. Fabrication and characterization. Organic transistors. FETs: Principle and device architecture.

Module 3

Plastic solar cells. Basic principles. Multilayer and heterojunction structures, cell architecture. Charge transport and exciton formation-effects of exciton diffusion, dissociation and luminescence. Photogeneration process in organic heterojunction photovoltaic cells. Processing of organic solar cells. Dyesensitization- dyesensitized solar cell.

Module 4

Essential characteristics of electrode materials for organic electronic devices – work function. Conductivity and transparency factors. Indium Tin Oxide (ITO) as anode material. Effect of ITO oxidative properties on efficiency and shelf life of organic electronic devices, novelinorganic anode materials and their limitations. Buffer organic layer protection to the active layer. Doping the device and annealing the device for increased efficiency and shelf life- architecture.

Module 5

Techniques in Organic electronic Device materials. Thin film coating techniques for devices fabrication. Spin coating, dip coating, doctor blading screen printing, inkjet printing, vapor deposition. R.F and microwave plasma assisted film coating.

Text Books

1. Bernier. Advancn syntheticcmetals.Elsevier(1999)
2. R.Farchioni(Editor)G.Grosso(Editor) Organic Electronic Materials. Conjugated polymers and low molecular weight organic solids. Springer series in materials science (2007)
3. Gregory Crawford. Flexible flat panel display, Wiley series indisplay technology(2005)
4. Klauk Hagen(ED).Wiley VCH. Organic electronics(2006)

References:

1. Gil. Semi conductors and Organic Materials for Opto electronic Application. Elsevier (1997)
2. Nalwa. Supra molecular photo sensitive and electro-active materials Elsevier(2001)
3. Eguer. Thin film materials for large area electronics. Elsevier(1999)

Course Contents and Lecture Schedule

No	Topic	No. of Lectures
1	Conducting Polymers	
1.1	Conducting polymer, Organic semiconductor, conduction mechanism, Pi and Sigma electron bandtheory. Conduction mechanism indoped polymeric semiconductors.	3
1.2	Polymers fundamentals-conducting polymers. Organic semiconductors, charge transport in conjugated polymers.	3
1.3	Physics of organic semiconductors (Luminescence, injection and transports properties) Methods of developing organic semiconductors.	2
2	Organic Electronic Devices	
2.1	Basic device architecture inorganic devices. Historical review. Organic light emitting diodes(OLED) and Polymer light emitting diodes (PLED).	3
2.2	Multilayer architecture. Single layer architecture. Bulk hetero-junctions. Operating characteristics and electrical characterization. Flexible electronics : new display media. Flexible displays device architecture.	3
2.3	Fabrication and characterization. Organic transistors. FETs: Principle and device architecture.	2
3	Organic Solar Cells	
3.1	Plastic solar cells. Basic principles. Multilayer and heterojunction structures, cell architecture.	2
3.2	Charge transport and exciton formation–effects of exciton diffusion, dissociation and luminescence. Photogeneration process in organic heterojunction photovoltaic cells.	3
3.3	Processing of organic solar cells. Dyesensitization– dyesensitized solar cell.	2
4	Organic Electronics-Materials	
4.1	Essential characteristics of electrode materials for organic electronic devices – work function. Conductivity and transparency factors.	2
4.2	Indium Tin Oxide (ITO) as anode material. Effect of ITO oxidative properties on efficiency and shelf life of organic electronic devices, novel inorganic anode materials and their limitations	2
4.3	Buffer organic layer protection to the active layer. Doping the device and annealing the device for increased efficiency and shelf life– architecture.	3
5	Techniques in Device making	
5.1	Techniques in Organic electronic Device materials. Thin film coating techniques for devices fabrication. Spin coating, dipcoating, doctor blading screen printing, inkjet printing,	3
5.2	Vapor deposition. R.F and microwave plasma assisted film coating. Vacuum Deposition Techniques	2

Model Question Paper

A P J ABDUL KALAM TECHNOLOGICAL UNIVERSITY
EIGHTH SEMESTER B. TECH DEGREE EXAMINATION
COURSE: ECT478 ORGANIC ELECTRONICS
TIME:3HRS. MAX. MARKS: 100

PART A**Answer All Questions**

1. Explain the concept of pi and sigma bond formation. (3)
2. Define the terms a) conjugated polymers (3)
b) luminescence
3. Explain the working principle of OLEDs. (3)
4. Obtain the electrical characterization of OLEDs. (3)
5. Give the significance of heterojunctions in plastic solar cell. (3)
6. Briefly explain the theoretical concept of the working of dye sensitized solar cell (3)
7. Distinguish between electron affinity and ionization potential with reference to energy bands. (3)
8. Mention the basic properties needed for an anode material. (3)
9. Write down the advantages of vapor deposition method? (3)
10. What is spin coating? Where is it applicable? (3)

PART B**Answer one question from each module. Each question carries 14 mark****Module I**

- 11(A) Explain the HOMO and LUMO and correlate with similar terms in inorganic semiconductors. (7)
- 11(B) Discuss how soliton causes transport of charges in conjugated polymers. (7)

OR

- 12(A) Describe the methods for developing organic semiconductors. (7)
- 12(B) Explain the conduction mechanisms in organic semiconductors. (7)

Module II

- 13(A) Explain the construction and working of bilayer OLEDs. (7)
- 13(B) With the help of energy band diagram, explain why work function matching is required between hole transport layer and emissive layer in PLEDs. (7)

OR

- 14(A) Describe the working mechanism of organic FET with relevant diagrams. (7)
- 14(B) Discuss the construction and features of flexible displays. (7)

Module III

- 15(A) What are the photovoltaic process in plastic solar cells? Discuss each. (7)
- 15(B) What are the different types of plastic solar cells? Explain each with its structure. (7)

OR

- 16(A) Explain the fabrication steps involved in the construction of plastic solar cells. (7)
16(B) Describe the electrical characterization of plastic solar cells. (7)

Module IV

- 17(A) What are the essential characteristics needed for materials to act as electrodes? (7)
17(B) Explain the importance of buffer layers in organic electronic devices. (7)

OR

- 18(A) Discuss the features of ITO and also its effect on the performance of organic electronic devices. (7)
18(B) Explain the different methods by which the efficiency of the organic electronics devices can be improved. (7)

Module V

- 19(A) Compare the vapor deposition and spin coating methods. (7)
19(B) Explain the screen printing technique. (7)

OR

- 20(A) Describe the RF and microwave plasma assisted coating method. (7)
20(B) Distinguish between doctor blading and ink jet printing methods. (7)



APJ ABDUL KALAM
TECHNOLOGICAL
UNIVERSITY

SEMESTER VIII

MINOR



ECD482	MINIPROJECT	CATEGORY	L	T	P	CREDIT
		PWS	0	0	3	2

Preamble: The course aims

- To estimate the ability of the students in transforming the theoretical knowledge studied in to a working model of an electronic system
- For enabling the students to gain experience in organisation and implementation of small projects.
- Design and development of Small electronic project based on hardware or a combination of hardware and software for electronics systems.

Course Plan

In this course, each group consisting of three/four members is expected to design and develop a moderately complex electronic system with practical applications, this should be a working model. The basic concept of product design may be taken into consideration.

Students should identify a topic of interest in consultation with Faculty/Advisor. Review the literature and gather information pertaining to the chosen topic. State the objectives and develop a methodology to achieve the objectives. Carryout the design/fabrication or develop codes/programs to achieve the objectives. Demonstrate the novelty of the project through the results and outputs. The progress of the mini project is evaluated based on a minimum of two reviews.

The review committee may be constituted by the Head of the Department. A project report is required at the end of the semester. The product has to be demonstrated for its full design specifications. Innovative design concepts, reliability considerations, aesthetics/ergonomic aspects taken care of in the project shall be given due weight.

Course Outcomes

CO1	Be able to practice acquired knowledge within the selected area of technology for project development.
CO2	Identify, discuss and justify the technical aspects and design aspects of the project with a systematic approach.
CO3	Reproduce, improve and refine technical aspects for engineering projects.
CO4	Work as a team in development of technical projects.
CO5	Communicate and report effectively project related activities and findings.

Mapping of course outcomes with program outcomes

	PO 1	PO 2	PO 3	PO 4	PO 5	PO 6	PO 7	PO 8	PO 9	PO 10	PO 11	PO 12
CO 1	3	3	3	2		3						2
CO 2	3	3	3	2		3					3	2
CO 3	3	3	3	2		3					3	2
CO 4								3		3	3	2
CO 5								3	3	3		2

Evaluation

The internal evaluation will be made based on the product, the report and a viva- voce examination, conducted by a 3-member committee appointed by Head of the Department comprising HoD or a senior faculty member, Academic coordinator for that program, project guide/coordinator.

The Committee will be evaluating the level of completion and demonstration of functionality/specifications, presentation, oral examination, work knowledge and involvement.

Mark distribution

Total Marks	CIE	ESE	ESE Duration
150	75	75	1 hour

Split-up of CIE

Component	Marks
Attendance	10
Marks awarded based on guide's evaluation	15
Project Report	10
Evaluation by Committee	40

Split-up of ESE

Component	Marks
Level of completion	10
Demonstration of functionality	25
Project Report	10
Viva-voce	20
Presentation	10

APJ ABDUL KALAM
TECHNOLOGICAL
UNIVERSITY

SEMESTER VIII

HONOURS



ECD496	MINIPROJECT	CATEGORY	L	T	P	CREDIT
		PWS	0	0	3	2

Preamble: The course aims

- To estimate the ability of the students in transforming the theoretical knowledge studied in to a working model of an electronic system
- For enabling the students to gain experience in organisation and implementation of small projects.
- Design and development of Small electronic project based on hardware or a combination of hardware and software for electronics systems.

Course Plan

In this course, each group consisting of three/four members is expected to design and develop a moderately complex electronic system with practical applications, this should be a working model. The basic concept of product design may be taken into consideration.

Students should identify a topic of interest in consultation with Faculty/Advisor. Review the literature and gather information pertaining to the chosen topic. State the objectives and develop a methodology to achieve the objectives. Carryout the design/fabrication or develop codes/programs to achieve the objectives. Demonstrate the novelty of the project through the results and outputs. The progress of the mini project is evaluated based on a minimum of two reviews.

The review committee may be constituted by the Head of the Department. A project report is required at the end of the semester. The product has to be demonstrated for its full design specifications. Innovative design concepts, reliability considerations, aesthetics/ergonomic aspects taken care of in the project shall be given due weight.

Course Outcomes

CO1	Be able to practice acquired knowledge within the selected area of technology for project development.
CO2	Identify, discuss and justify the technical aspects and design aspects of the project with a systematic approach.
CO3	Reproduce, improve and refine technical aspects for engineering projects.
CO4	Work as a team in development of technical projects.
CO5	Communicate and report effectively project related activities and findings.

Mapping of course outcomes with program outcomes

	PO 1	PO 2	PO 3	PO 4	PO 5	PO 6	PO 7	PO 8	PO 9	PO 10	PO 11	PO 12
CO 1	3	3	3	2		3						2
CO 2	3	3	3	2		3					3	2
CO 3	3	3	3	2		3					3	2
CO 4								3		3	3	2
CO 5								3	3	3		2

Evaluation

The internal evaluation will be made based on the product, the report and a viva- voce examination, conducted by a 3-member committee appointed by Head of the Department comprising HoD or a senior faculty member, Academic coordinator for that program, project guide/coordinator.

The Committee will be evaluating the level of completion and demonstration of functionality/specifications, presentation, oral examination, work knowledge and involvement.

Mark distribution

Total Marks	CIE	ESE	ESE Duration
150	75	75	1 hour

Split-up of CIE

Component	Marks
Attendance	10
Marks awarded based on guide's evaluation	15
Project Report	10
Evaluation by Committee	40

Split-up of ESE

Component	Marks
Level of completion	10
Demonstration of functionality	25
Project Report	10
Viva-voce	20
Presentation	10